

## SPECIFICATIONS

### General

RX Frequency Range : 100 kHz ~ 30 MHz  
 TX Frequency Ranges : 160 ~10 m (Amateur bands only)  
 Frequency Stability : ± 0.5 ppm (after 1 min. @ 25 /77 )  
 ± 0.25 ppm (after 1 min. @ 25 /77 ,  
 w/TCXO-6)

Operating Temperature Range: -10 ~ +50 /14 ~ 122  
 Emission Modes : LSB, USB, CW, FSK, AFSK, AM, FM  
 Frequency Steps : 0.625/1.25/2.5/5/10 Hz for  
 SSB,CW, RTTY & Packet  
 100 Hz for AM and FM

Antenna Impedance : 50 Ohms, unbalanced  
 16.6~150 Ohms, unbalanced  
 (Tuner ON, TX only)

Power Consumption:

Dimensions (WHD) : 16 "x 5.3 "x 13.7 "  
 (410 x 135 x 347 mm)  
 Weight (approx.) : 33 lbs. (15 kg.)

### Transmitter

Power Output : Adjustable up to 100 watts  
 (25 watts AM carrier),  
 Class A mode (SSB) : 25 watts maximum  
 Duty Cycle : 100% @ 50 watts,  
 50% @ 100 watts (FM & RTTY, 3-minute TX)

Modulation Types: SSB: J3E Balanced,  
 AM: A3E Low-level (early stage),  
 FM: F3E Variable reactance,  
 AFSK: J1D, J2D Audio frequency shift keying

Maximum FM Deviation: ± 2.5 kHz  
 FSK Shift Frequencies: 170, 425, and 850 Hz  
 Packet Shift Frequencies: 200 and 1000 Hz  
 Harmonic Radiation : Better than -60 dB (Typical)

SSB Carrier Suppression: At least 40 dB below peak output  
 Undesired Sideband Suppression: At least 55 dB below peak output  
 Audio Response (SSB): Not more than -6 dB  
 from 400 to 2600 Hz

3rd-order IMD: - 31 dB @ 100 watts PEP, or better  
 (Class A mode) - 40 dB @ 25 watts PEP (Typical)

Microphone Impedance: 500 to 600 Ohms

### Receiver

Circuit Type : Quad-conversion superheterodyne  
 (triple conversion for FM)

Intermediate Frequencies:  
 Main RX; 70.455 MHz/8.215 MHz/455 kHz,  
 Sub RX; 47.21 MHz/455 kHz

Sensitivity :	Modes	0.5 - 1.8 MHz	1.8 - 30 MHz
	SSB/CW (2.0 kHz)	2 µV	0.16 µV
	AM (6 kHz)	13 µV	2 µV
	FM	-	0.5 µV

(with preamp on, IDBT on, SSB/CW/AM for 10 dB S/N,  
 FM for 12 dB SINAD, 0 dBµ = 1 µV)

Selectivity (-6/-60 dB):

BandWidth	Modes	Min. -6 dB BW	Max. -60 dB BW
2.4 kHz	all except FM	2.2 kHz	4.2 kHz
2.0 kHz	all except FM	1.8 kHz	3.6 kHz
500 Hz	CW/RTTY/Packet	500 Hz	1.8 kHz
250 Hz	CW/RTTY/Packet	250 Hz	700 Hz
	AM (Wide)	4 kHz	14 kHz
	FM	8 kHz	19 kHz

IF Rejection (1.8 ~ 30 MHz):  
 80 dB or better (Main RX), 60 dB or better (Sub Rx)

Image Rejection (1.8 ~ 30 MHz):  
 80 dB or better (Main), 50 dB or better (Sub)

Maximum Audio Output: 2.0 W into 4 Ohms with <10 % THD  
 Audio Output Impedance: 4 to 8 Ohms

Specifications are subject to change, in the interest of technical  
 improvement, without notice or obligation.

Desktop Microphone  
 MD-100A8x

Digital Voice Recorder DVS-2	Remote Control Keypad FH-1	Lightweight Stereo Headphone YH-77STA	External Speaker w/Audio Filters SP-8 LL-7 Phone Patch Option	Temperature Compensated X'tal TCXO-6
---------------------------------	-------------------------------	---	--	--

SSB 2.0 kHz X'tal Filter YF-114SN	SSB 2.0 kHz X'tal Filter YF-110SN
CW 250 Hz X'tal Filter YF-114CN	CW 250 Hz X'tal Filter YF-110CN
	CW 500 Hz Filter (Collins Mechanical Filter) YF-115C

About this brochure: we have made this brochure as comprehensive and factual as possible. We reserve the right, however, to make changes at any time in equipment, optional accessories, specifications, model numbers, and availability. Some accessories shown herein may not be available in some countries. Some information may have been updated since the time of printing; please check with your Authorized Yaesu Dealer for complete details.

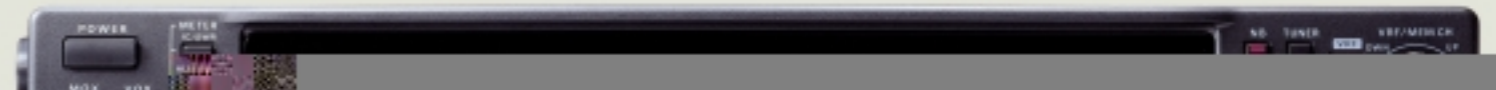

# Building on the tremendous success of the 200-Watt FT-1000D and MARK-V FT-1000MP Elite-Class HF Transceivers, the MARK-V Field brings this leading-edge technology to you in a 100-Watt self-contained transceiver design.

## Field CLEAN 100-WATT TRANSMITTER WITH FULLY-AUTOMATIC ANTENNA TUNER

### Conservative 100W Low Distortion Final Amplifier Design

The Field utilizes a pair of high-dissipation 2SC2879 bipolar transistors in a push-pull design, driven by push-pull 2SC3133s, yielding a low-distortion 100-Watt transmitter compatible with the Class-A operation capability pioneered on the MARK-V FT-1000MP. These transistors are run well below their rated output, and are utilized in conjunction with pure local oscillator signals and time-proven low-pass filter designs, to provide you with the cleanest signal on the band! During Class-A operation, SSB power output becomes 25 Watts, and transmitter intermodulation products will be significantly better than Class AB.

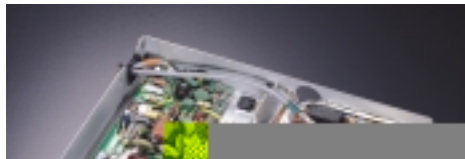

High-reliability PA and LPF modules

### High-Efficiency Cooling System

Renowned for its reliability in heavy-hitting contest and DX-pedition applications, the Field includes a new, high-efficiency heat sink design featuring a copper bonding plate between the PA transistors and the die-cast heat sink assembly. Combined with the thermostatically-controlled cooling fan of the original FT-1000MP, the Field runs comfortably cool even during Class-A SSB or intense CW contest operation. Years of design and manufacturing know-how have enabled the Yaesu design team to craft a cooling system that won't let you down!



Copper Thermal Bonding Plate for Improved Dissipation



Efficient Heat Sink and Cross-Flow Cooling Fan

### High-Speed Automatic Antenna Tuner

The efficient Automatic Antenna Tuner design of the Mark-V has been adapted for 100-Watt operation, for lightning-fast tuning and high output power. Capable of matching loads between 16.5 and 150 to a better than 1.2:1 SWR, the Automatic Antenna Tuner's dedicated microprocessor utilizes a complex analysis algorithm which permits lightning-quick matching of impedance mismatches, and it memorizes stored tuning settings with 10.24 kHz resolution. The result: more power delivered to the antenna, and less time wasted in tuning!

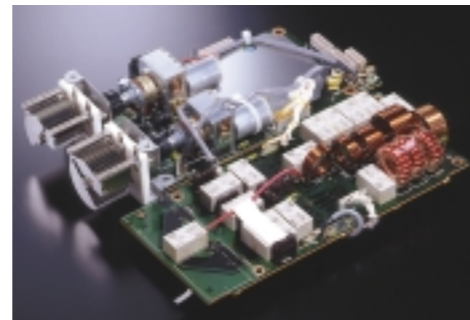

100-Watt Automatic Antenna Tuner

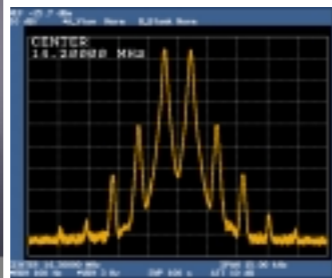

Typical TX IMD: Class A (25W Output)

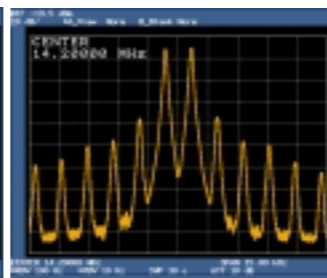

Typical TX IMD: Class AB (100 W Output)

## Field HIGH-PERFORMANCE, ALL-IN-ONE DESIGN

For those who want the very best, at home or on a DX-pedition, using AC or DC power sources, the MARK-V Field is without peer in price or performance. The internal switching-regulator power supply is the ultra-low-noise design first used in the FT-1000MP, and you just hook up the optional DC cable E-DC-20 to a 13.8-Volt DC source for field-day or emergency operation.



## IDBT: INTERLOCKED DIGITAL BANDWIDTH TRACKING SYSTEM

### Interlocked Digital Bandwidth Alignment Technique

The MARK-V Field introduces a unique and formidable interference-fighting system with the development of IDBT, whereby the bandwidth of the Digital Signal Processing filter is automatically locked to be the same as the net bandwidth of the analog SSB filters. Engaging the IDBT, the operator experiences a sudden sharpening of the shape factor of the receiver's filter system. The analog IF, which utilizes cascaded crystal and/or mechanical filters, includes both IF WIDTH and IF SHIFT controls, which allow

modification of the IF passband width and center frequency. With IDBT, the DSP filter is automatically re-programmed so as to match the custom bandwidth you just set, and the DSP filter then contributes a filtering slope which resembles a sheer cliff! The results? The incredible selectivity of an all-DSP system with the protection of the DSP afforded by the extensive IF analog filtering. What's more, the potential for AGC "pumping" caused by different analog and digital bandwidths is eliminated; thus, the need for separate analog and DSP AGC systems is also

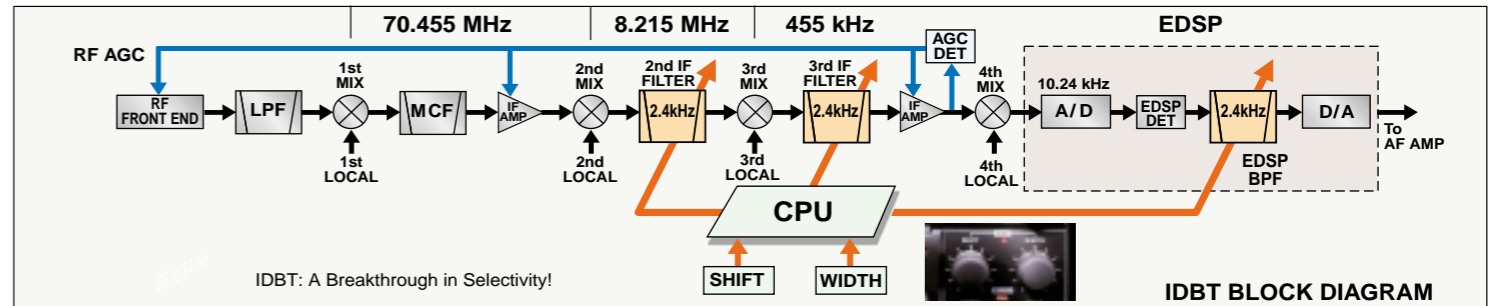

## VARIABLE RF FRONT-END FILTER

### VRF Preselector Filtering Protects Receiver Front End (160M ~ 20M)

Extending the protection afforded the sensitive front-end components of the receiver, Yaesu's engineers have developed the VRF module: a High-Q input "Preselector" filter ahead of all active devices in the front end, including the main bandpass filters! Particularly in multi-operator contest or DX-pedition environments, where large low-band antennas may be in close proximity, a receiver operating (for example) on 20 meters can suffer intermodulation interference from on-site 40- and 80-meter signals, compounded by extremely strong 7 MHz broadcast signals. The VRF circuit provides narrow-band selectivity which prevents this unwanted signal voltage from hitting the input side of the bandpass filter switching diodes, where 2nd-order IMD is most often created in an HF

receiver. Tuning of the VRF is incredibly simple: just turn the VRF/MEM CH knob, and peak the background noise or signal strength!

The VRF is stoutly designed, with large (10 mm x 10 mm) coils yielding high Q, and precision tuning capacitors ensuring that performance does not degrade over time. A total of 31 tuning memories per band allow very quick QSY, and the use of high-quality, shielded relays for VRF selection ensures that nothing in the VRF can itself contribute IMD.

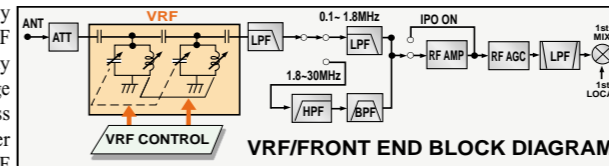

## ENHANCED ERGONOMICS: MULTI-FUNCTION SHUTTLE JOG DIAL

**Quick Access to VRF and IDBT via Shuttle Jog Tuning Ring**  
The immensely-popular Shuttle Jog tuning ring, which is concentric with the Main Tuning Knob, has a new look in the MARK-V Field: it now includes the activation switches for the VRF (left side) and IDBT

(right side) features, so the operator does not have to move his hand position to activate these important circuits during contest or pile-up situations!

**Superb Ergonomics Across the Front Panel**  
Both the Main and Sub VFO Tuning Knobs are larger,

gone, eliminating the very real danger of annoying cross-AGC artifacts which can seriously degrade receiver performance. And in the 455 kHz analog IF you get a 10-pole Collins Mechanical SSB filter, providing outstanding voice signal reproduction along with enhanced skirt selectivity compared to earlier 8-pole designs. The IDBT function is controlled by an allocation of up to 60 kbytes of ROM in the Main CPU, while the DSP performance utilizes 1 Mbyte of EEPROM! This perfect blending of the analog and digital worlds brings you, today's Elite-Class operator, the most crunch-proof receiver filtering ever!

### Receiver Front End Highlights

The MARK-V Field adopts the low-noise front end design of the MARK-V. Two low-noise Junction FET preamplifiers are provided, one in a "tuned" configuration with optimized gain and noise figure independently for the high and low bands, with the other "flat" preamp providing a wide, uniform-gain response. The first mixer utilizes a quad of SST-310 Junction FETs in a doubly-balanced circuit, resulting in wide dynamic range. Eleven bandpass filter networks provide input protection for the front end, working in concert with the VRF to provide the best-ever 2nd-order IMD prevention in an Amateur transceiver.

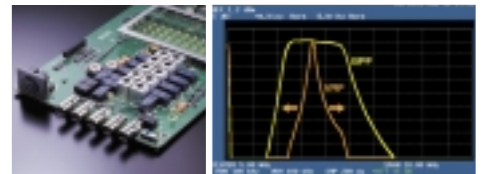

allowing silky-smooth tuning even if you have large fingers! The right side of the front panel contains the adjustment controls for the VRF, IDBT, NOTCH, and CLARIFIER, conveniently grouped so you can get at them quickly. For contest or DX-pedition use, you cannot afford to lose even milliseconds in search of a



### Easy-Access " SPLIT " Operation

When seconds count in a DX pile-up, the convenience of the MARK-V Field's " SPLIT " operating mode can't be beat! The " RX " (green) and " TX " (red) LEDs above the Main and Sub VFO tuning dials are actually combination LED/Switches; pressing the Sub VFO's " TX " LED automatically shifts the transmitter to control by the Sub VFO, with receiver control still on the Main VFO. Pressing the Sub VFO's " RX " LED activates Dual Receive, so you're listening on both VFOs, while transmitting on the Sub VFO. It's easy, it's intuitive, and it's quick!

### ENHANCED DIGITAL SIGNAL PROCESSING



EDSP Unit

### Highly-Effective Digital Noise Reduction Circuit

Utilizing mathematical algorithms developed after thousands of hours of on-the-air evaluation, the EDSP Noise Reduction provides four different Noise Reduction

patterns, to allow you to cope with changing noise conditions. The algorithms utilized in the development of the EDSP Noise Reduction cover the vast majority of noise patterns encountered on the HF bands.

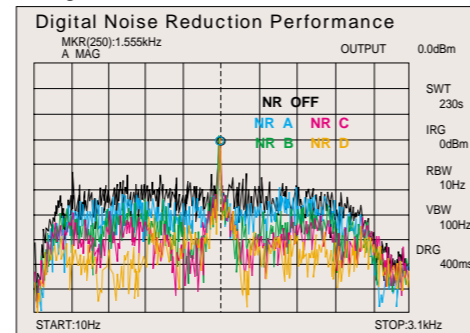

### Optimized Narrow-Bandwidth Filters for CW and Data Modes

For razor-sharp selectivity under marginal conditions, the EDSP CW Audio Peaking Filter provides bandwidths of 60, 120, or 240 Hz. Filter selection is accomplished using a convenient pushbutton switch on the left side of the front panel.

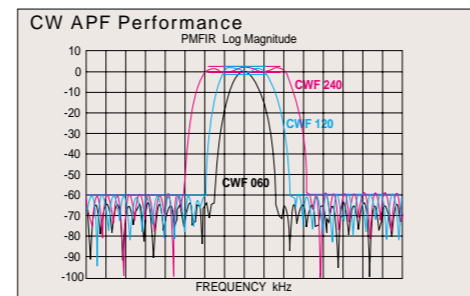

Besides the CW Audio Peaking Filter, specially-designed and optimized digital-mode filters are provided, for maximum data throughput on RTTY, Packet, SSTV, PSK31, or FAX.

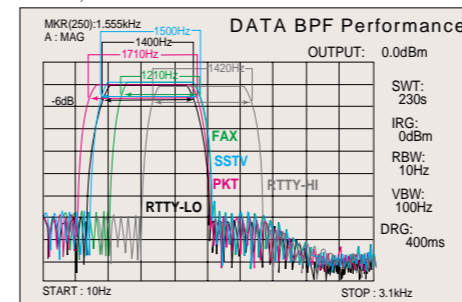

### Selectable SSB Pattern-Contour Filters

Particularly effective in enhancing signal-to-noise ratio and intelligence recovery on SSB signals, the Contour selections include High-Cut, Low-Cut, and Mid-Cut responses, with a color-coded indicator aiding in filter selection. Choose the one that causes the incoming voice to " pop " out of the background noise!

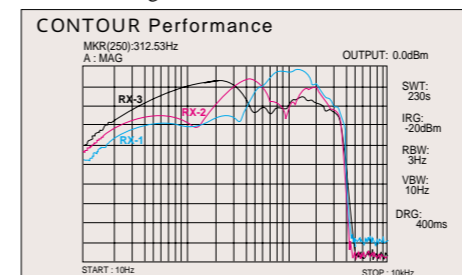

### Selectable Digital Modulation/Demodulation

Among EDSP's more advanced technology are the digital Modulator and Demodulator circuits. On transmit, the EDSP Modulator provides improved transmitter signal-to-noise ratio, very flat frequency response, and a choice of four cutoff frequencies (100, 150, 200, or 300 Hz) on the low-frequency side (high-frequency cutoff: 3100 Hz). Whether you're rag-chewing or in a DX contest, the MARK-V Field provides a frequency response that's ideal for you! Providing a boundary for the receiver's SSB bandwidth within the EDSP, you can select either 100-3100 Hz or 300-2800 Hz filters in the EDSP Demodulator circuit, which provides very low noise with no odd DSP artifacts or distortion.

### Digital SSB Microphone Equalizer & RF Speech Processor

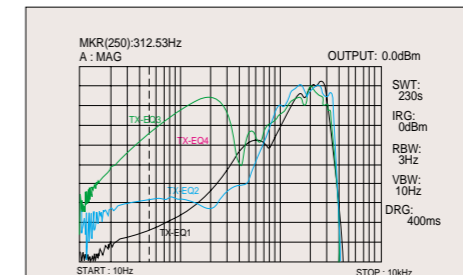

### INDUSTRY-LEADING RF FRONT END DESIGN

**DX-pedition and Contest operators alike have acclaimed the strong-signal performance and antenna selection convenience of the FT-1000 Series. This legacy is renewed in the MARK-V Field!**

### Two TX/RX Antenna Ports plus Receive-only Antenna Line Jacks

The " A " and " B " antenna jacks allow connection of different antennas, which may be selected using the front panel's A/B switch. The antenna selected on a particular VFO/memory and band will be preserved in that VFO or memory register, and will be automatically recalled when you return to that VFO or memory.

# QUADRA SYSTEM (Optional)

## HF/50 MHz 1 kW Linear Amplifier/48 Volts DC Power Supply

### VL-1000 / VP-1000

#### Dual-Mode IF Noise Blanker

The adjustable IF Noise Blanker may be configured for optimum blanking of (A) narrow-pulse ignition-type noises, or (B) wide-pulse over-the-horizon radar systems.

#### Synchronous AM Detection for Reduced Fading

The "Synchronous" detection technique provides improved AM reception by significantly reducing fading. The incoming signal is removed, reception is converted to SSB, and a non-fading carrier is re-inserted, thereby eliminating the chief cause of fading. A Synchronous Tuning Scale on the display assists in the tuning process.

#### CW FEATURES FOR OPERATORS DEMANDING THE BEST

##### CW Full Break-in and Electronic Keyer

The ultra-fast response time of the Direct Digital Synthesizer (DDS) allows full break-in (QSK) operation, without perceptible character truncation. The built-in electronic keyer features separate Dot:Space and Dash: Space weight settings, and the receiver recovery time during semi-break-in work may be set optimally for CW, independently from the SSB "VOX Delay" setting.

##### CW Spot

Align yourself precisely with the station being worked by the DX station in a pile-up.



##### CW Pitch

Select filter center frequency, TX offset, and Sidetone pitch over the range 300-1050 Hz, and use the SPOT switch to zero in on the other station.

##### CW Reverse Tuning

Choose either USB- or LSB-side injection to combat interference, or to switch a station from SSB to CW without guesswork as to the operating frequency!

##### CW Tuning Indicator

Provides visual confirmation of precise tuning on receive.

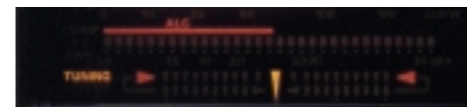

##### Two Key Jacks

Front- and rear-panel paralleled KEY jacks allow easy connection to paddles, external electronic keyers, or computer-driven keying interfaces.

##### Electronic Memory Keyer

Use the optional FH-1 Remote Keypad (or build your own keypad) to activate the onboard electronic message memory keyer. Four messages of up to 50 characters each may be programmed, and an incrementing contest number may also be imbedded into a recorded message.

#### CONVENIENCE FEATURES FOR WORLD-CLASS HF OPERATORS

The FT-1000 series has been universally acclaimed, not only for their industry-leading RF and IF innovations, but also for the wealth of operating conveniences made available to demanding HF operators. The MARK-V Field builds on this tradition in an all-in-one AC/DC design!

##### Unmatched Ergonomic Front Panel Design Concept

Owners of Yaesu's FT-1000 family of Elite-Class transceivers use them under the most stressful conditions. Over long hours of operation, the carefully designed front-panel ergonomics are a profound asset for the

operator, whether on a DX-pedition on a faraway island or at home at 4 o'clock in the morning. Borrowing extensively from the FT-1000MP front panel layout, the MARK-V Field features larger knobs, reduction in the total knob/button count, and enhanced ease of operation as a result of the intensive ergonomic system analysis applied by Yaesu's engineers. This effort, coupled with feedback from users like you, has resulted in an incredibly complex transceiver also being incredibly easy to use!

##### Multi-Function Display with Improved Contrast

The MARK-V Field's multi-function display provides a wealth of transceiver status in a conveniently-arranged layout, and it boasts improved contrast compared to previous designs. The area around the Main VFO frequency display contains the most-often-used information, such as Clarifier Offset, VRF Tuning Scale, Antenna Tuner status, and VFO / Memory status.



##### High-Resolution DDS Provides Silky-Smooth Tuning

Yaesu pioneered the use of the DDS (Direct Digital Synthesizer) in modern HF transceivers, and the MARK-V's DDS system is the latest, greatest evolution of this design technique. The DDS provides ultra-fine tuning steps as small as 0.625 Hz, ideal for the slow tuning needed for HF digital work. And the very low noise of the DDS-based local oscillator system yields a very low noise floor during reception and transmission.



##### Enhanced Shuttle Jog™ Tuning Dial

Instantly popular on the original MARK-V, the Shuttle Jog™ dial, concentric with the Main VFO tuning dial, is a spring-loaded center-off tuning aid which allows the operator to make progressively larger scans up and down the band by "leaning" on the Shuttle Jog™ to the left or right. A slight displacement of the dial causes tuning in 10 Hz steps, and full rotation of the dial to the left or right yields steps as large as 100 kHz per step—you'll watch the Megahertz fly by if you need to QSY quickly! The Shuttle Jog™ tuning speed may be adjusted via the Menu system, so you can set it up just the way you want it! And with the addition of the VRF and IDBT On/Off switches on the Shuttle Jog™ ring, you'll find little need for your hand from the central area of the transceiver during critical moments!

##### VRF/MEM Channel Selector

The VRF/MEM Channel Selector knob, located in the upper right-hand corner of the front panel, also functions as a VFO Channel Selector for quick and easy QSY in user-programmer steps of 1 to 100 kHz. Use 1 kHz to 5 kHz steps for cruising up and down the band, or 50 kHz steps for general-coverage frequency hopping. A simple press on this control restores VRF (Preselector) operation, and you'll be ready for action!

##### Direct Keypad Frequency Entry; Twin Stacked VFO Registers

The convenient 10-key direct frequency entry keypad provides instant frequency setting anywhere within the range of the transceiver. The "Band" keys on the keypad also provide one-touch band change, and the two VFOs available per amateur band allow one VFO to be set for the CW segment, and the other for the phone segment, with the mode, bandwidth, and antenna selections for each segment being automatically memorized into each VFO register.

##### Feature Customization Menu

For configuration of the MARK-V Field just the way you want it, many "set and forget" features and functions may be customized via the Menu system. The Menu provides access to the settings for a number of operating

parameters which are not needed during everyday operation; the use of the Menu technique significantly reduces the total number of knobs and switches on the front panel, making long hours of operation even more enjoyable.

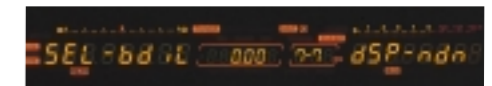

##### Extensive Memory System, including 5-Channel Quick Memory Bank (QMB)

The MARK-V provides 99 regular memory channels, five QMB memories, and nine "band limit" memories. The "regular" memories may be assigned into one of five memory "groups," for convenience in recalling of the memories. Besides the operating frequency, memory channels store operating mode, antenna selection, Clarifier offset (if any), IF filter selection, and repeater shift status (if applicable).

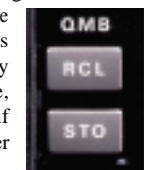

##### Versatile Scanning Capability

The acclaimed scanning features of the MARK-V Field include a number of capabilities which make HF operation a breeze. These include:

**Memory/VFO Scan:** Scan the memories, or scan the band, with the scanning speed being adjustable, via Menu, independently for Memory and VFO Scan. An Auto-Write feature allows "busy" channels to be written into memory automatically, if desired.

**Memory Channel "Skip" Scanning:** You can "flag" certain memories to be skipped during scanning, so the transceiver is not constantly halting on constantly-busy frequencies like WWV.

**Programmable Memory Scan (PMS):** You may use and scanning. For example, within the 18.0-18.5 MHz range, you may limit operation to the range 18.068 to 18.168 MHz, to prevent accidental excursions outside the amateur band segment.

##### Easy Digital-Mode Interfacing

The exciting world of digital mode operation is more popular than ever! And the MARK-V Field is unmatched in its ease of interfacing, whether you're interested in PSK-31, RTTY, Packet, SSTV, or Fax. Dedicated rear-panel FSK and AFSK jacks make cabling a breeze, and customized EDSP and IF filter selections make sure that you're never forced to use a non-optimal bandwidth during digital operation.

##### Built-in Temperature-Compensated Reference Oscillator

The Temperature-Compensated Reference Oscillator, is built into every MARK-V Field. The TCXO provides frequency accuracy of 0.5 ppm at 25 °C, and 2.0 ppm over the temperature range -10 to +50 °C. For ultra-precise frequency accuracy, the optional TCXO-6 provides accuracy of 0.25 ppm at 25 °C, and 0.5 ppm at -10 to +50 °C.

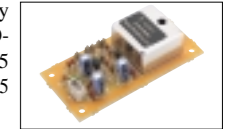

TCXO-6 (Optional)

#### AND SO MUCH MORE

General Coverage Reception: 100 kHz ~ 30 MHz. Large, high-quality speaker (3-5/8" / 92 mm) for better receive audio clarity. Two headphone jacks: one each 6 and 3.5 mm. Adjustable "Beep" tone for keypad keys. Adjustable torque for tuning knobs. Built-in VOX. FAST tuning key for quick frequency change. Built-in RS-232C level converter for easy computer interfacing.

#### OUTSTANDING IF FILTER CHAIN

Yaesu's hybrid Analog/DSP IF design reflects our commitment to bring you the toughest, most QRM-resistant receiver possible!

Carefully-Specified 8.2 MHz and 455 kHz IF Filters

IF Filter Bandwidth Selections						
Factory-installed IF Filter Selections						
BAND WIDTH	NOR		NAR.1		NAR.2	
	2nd IF (8.2MHz)	3rd IF (455kHz)	2nd IF	3rd IF	2nd IF	3rd IF
2.4kHz	2.4kHz	2.4kHz	-	-	-	-
2.4kHz	500Hz	2.4kHz	-	-	-	-
6.0kHz	2.4kHz	2.4kHz	-	-	-	-
2.4kHz	-	-	500Hz	2.4kHz	-	-

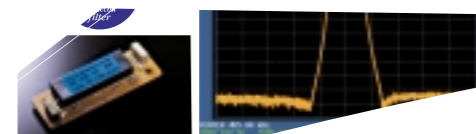
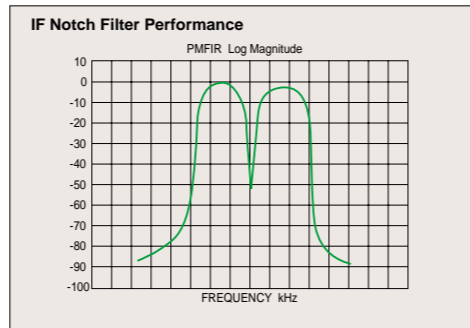
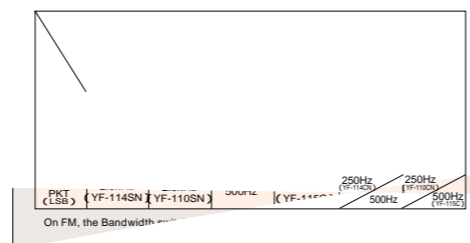

10-pole Collins® Mechanical

##### 455 kHz IF NOTCH features Improved Rejection

The newly-designed 455 kHz IF Notch Filter provides improved beat rejection, typically 50 dB or more. Use the front-panel NOTCH control to adjust the exact position of the Notch.

The MARK-V Field may be configured (via the convenient Menu system) to engage both the manual IF Notch Filter and the DSP Auto-Notch Filter, allowing cascaded Analog/Digital Notch Filtering. Say "Good-bye" to irritating beatnotes forever!

#### Three RF Preamplifier Modes plus IPO (Direct Mixer Feed)

riatic  
man/  
in.  
rea  
d  
ill  
gy  
Interce . P  
according

#### Four-Level Input RF Attenuator

For fine-tuning the front-end gain, or for comfortable listening to extremely strong local signals, the Attenuator circuit provides 6/12/18 dB of gain reduction (plus "Off").

#### RF GAIN Control

precise setting of the background noise level, or modifying the receiver's GC. The RF GAIN control is a shaft as

#### AUTO-AGC

For ease in operation, the "AUTO" AGC mode provides mode-specific selection of the receiver recovery time for the Automatic Gain Control system. Manual selections of FAST, SLOW, and OFF are also provided.