



Dual Band FM Transceiver

FT-7800R

Technical Supplement

1003 VERTEX STANDARD CO., LTD. (EH016M90)

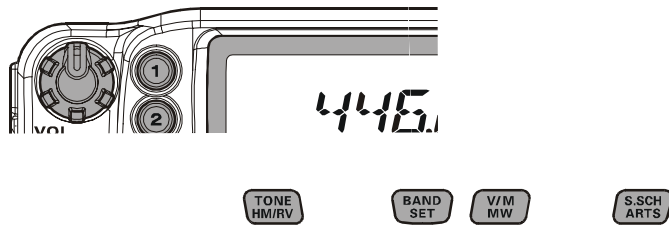

Int.

This manual

Servicing this transceiver is intended for persons to service it in some countries.

Two PCB layout configurations are referred to by the type numbers. The front side has only chip components, while the back side has electrolytic capacitors, etc.

While we believe the technical information is accurate, we do not assume any responsibility for any damage that may occur as a result of using this manual. There may be inconsistencies in the technical information.

Specifications
Exploded View & Miscellaneous Parts
Block Diagram
Circuit Description
Alignment

Specifications

General

Frequency Range:	RX: 108.000 - 520.000 MHz, 700.000 - 999.995 MHz (Cellular Blocked) TX: 144.000 - 148.000 MHz or 144.000 - 146.000 MHz, 430.000 - 450.000 MHz or 430.000 - 440.000 MHz
Channel Steps:	5/10/12.5/15/20/25/50/100 kHz
Modes of Emission:	F3E, F2D, F2A
Antenna Impedance:	50 Ohms, unbalanced (Antenna Duplexer built-in)
Frequency Stability:	±5 ppm @ 14 °F ~ +140 °F (-10 °C ~ +60 °C)
Operating Temperature Range:	-4 °F ~ +140 °F (-20 °C ~ +60 °C)
Supply Voltage:	13.8 VDC (±15 %), negative ground
Current Consumption (Approx.):	RX: 0.5 A (Squelched) TX: 8.5 A
Case Size (W x H x D):	5.5" x 1.6" x 6.6" (140 x 41.5 x 168 mm) (w/o knobs & connectors)
Weight (Approx.):	2.2 lb. (1 kg)

Transmitter

Output Power:	50/20/10/5 W (144 MHz) 40/20/10/5 W (430 MHz)
Modulation Type:	Variable Reactance
Maximum Deviation:	±5 kHz
Spurious Radiation:	At least -60 dB below
Microphone Impedance:	2 kΩ
DATA Jack Impedance:	10 kΩ

Receiver

Circuit Type:	Double-conversion superheterodyne
Intermediate Frequencies:	45.05 MHz/450 kHz
Sensitivity:	0.8 μV (TYP) for 10 dB SN (108 - 137 MHz, AM) 0.2 μV for 12 dB SINAD (137 - 150 MHz, FM) 0.25 μV for 12 dB SINAD (150 - 174 MHz, FM) 0.3 μV (TYP) for 12 dB SINAD (174 - 222 MHz, FM) 0.25 μV (TYP) for 12 dB SINAD (222 - 300 MHz, FM) 0.8 μV (TYP) for 10 dB SN (300 - 336 MHz, AM) 0.25 μV for 12 dB SINAD (336 - 420 MHz, FM) 0.2 μV for 12 dB SINAD (420 - 520 MHz, FM) 0.4 μV (TYP) for 12 dB SINAD (800 - 900 MHz, FM) 0.8 μV (TYP) for 12 dB SINAD (900 - 999.99 MHz, FM)
Squelch Sensitivity:	Better than 0.16 μV
Selectivity (-6dB/-60dB):	12 kHz/30 kHz
Maximum AF Output:	2 W @ 8 Ω for 10% THD
AF Output Impedance:	4-16 Ω

Specifications are subject to change without notice, and are guaranteed within the 144 and 430 MHz amateur bands only. Frequency ranges will vary according to transceiver version; check with your dealer.

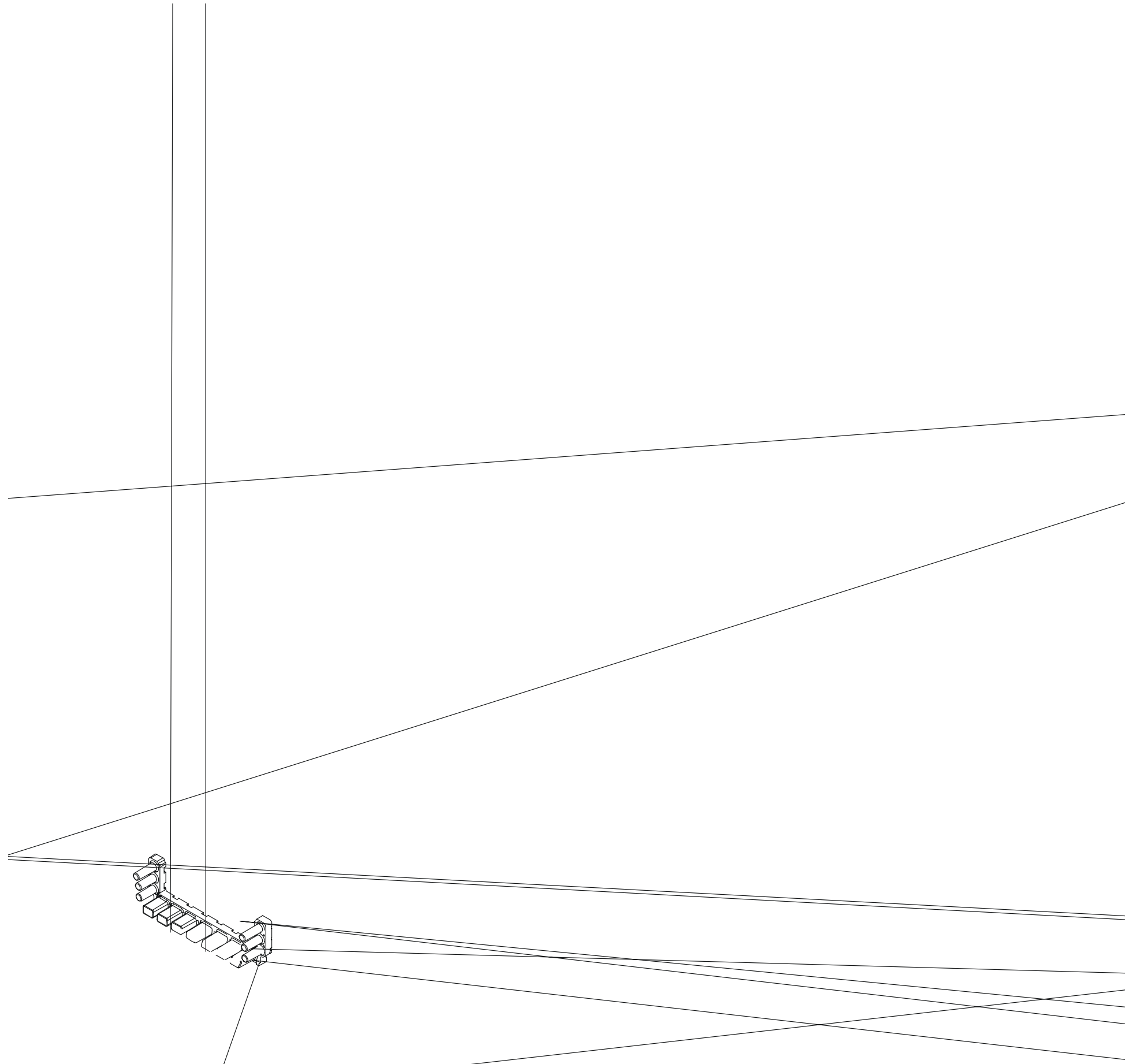

Exploded View & Miscellaneous Parts

Note

Block Diagram

No e

VHF Reception

The incoming VHF signal is passed through a low-pass filter network, antenna switching diodes D1074 (**RLS135**), D1075 (**RLS135**) and D1015 (**HVC131**), and another low-pass filter network to the RF amplifier Q1008 (**3SK296ZQ**). The amplified RF signal is passed through a varactor controlled bandpass filter consisting of L1017, L1018, and D1010, D1011, and D1012 (all **HVC365**), then applied to the first mixer Q1009 (**3SK296ZQ**) along with the first local signal from the PLL circuit.

The first local signal is generated between 189.05 MHz and 193.05 MHz, depending on the receiving frequency, by the VHF VCO, which consists of Q1076 (**2SC5374**) and varactor diodes D1049 (**HVC365**), D1050 (**HVC131**), D1051 (**HVC365**), and D1052 (**HVC362**).

UHF Reception

The incoming UHF signal is passed through a low-pass filter network, antenna switching diodes D1077 (**UM9401F**) and D1018 (**RLS135**), D1019 (**RLS135**), and D1084 (**HSC277**), and another low-pass filter network to the RF amplifier Q1001 (**3SK296ZQ**). The amplified RF signal is passed through a varactor-controlled band-pass filter consisting of L1006 and L1007, and D1002, D1003, and D1004 (all **HVC350B**), then applied to the first mixer Q1002 (**3SK296ZQ**) along with the first local signal from the PLL circuit.

The first local signal is generated between 384.95 MHz and 404.95 MHz, depending on the receiving frequency, by the UHF VCO, which consists of Q1072 (**2SC5006**) and varactor diodes D1046 (**HVC375B**) and D1047 (**HVC350B**).

IF and Audio Circuits

The 45.05 MHz first IF signal is applied to the monolithic crystal filter XF1001 which strips away unwanted mixer products, and the IF signal is applied to the first IF amplifier Q1016 (**2SC4400**). The amplified first IF signal is then delivered to the FM IF subsystem IC Q1023 (**TA31136FN**), which contains the second mixer, limiter amplifier, noise amplifier, and FM detector.

The 44.6 MHz second local signal is derived from 11.15 MHz crystal X1002, the frequency of which is multiplied by four at Q1022 (**2SC4400**), producing the 450 kHz second IF signal when mixed with the first IF signal within Q1023 (**TA31136FN**).

The 450 kHz second IF signal is applied to the ceramic filter CF1001 which strips away all but the desired signal, and then passes through the limiter amplifier within Q1023 (**TA31136FN**) to the ceramic discriminator CD1001 which removes any amplitude variations in the 450 kHz IF signal before detection of speech.

The detected audio passes through the de-emphasis network, a low-pass filter consisting of Q1028 (**NJM2902V**) and associated circuitry, and a high-pass filter consisting of Q1028 (**NJM2902V**) and associated circuitry. The filtered audio signal is passed through the audio volume control IC Q1034 (**M51132FP**) which adjusts the audio sensitivity to compensate for audio level variations, then delivered to the audio switch Q1036 (**DTC144EE**).

Squelch Control

When no carrier received, noise at the output of the detector stage in Q1023 (**TA31136FN**) is amplified and band-pass filtered by the noise amp section of Q1023 (**TA31136FN**). The resulting DC voltage is applied to pin 2 of main CPU Q1065 (**M3826AEFGP**), which compares the squelch threshold level to that which set by the front panel SQL knob.

While no carrier is received, pin 53 of Q1065 (**M3826AEFGP**) remains "low," to disable audio output from the speaker.

Transmit Signal Path

The speech signal from the microphone passes through the MIC jack J2001 to AF amplifier Q2011 (**NJM2904V**) on the PANEL unit. The amplified speech signal is subjected to amplitude limiting by Q1040 (**NJM2902V**) on the MAIN unit. The speech signal then passes through low-pass filter network Q1040 (**NJM2902V**) and band switch Q1039 (**BU4066BCFV**) to the VHF VCO or UHF VCO.

VHF Transmit Signal Path

The adjusted speech signal from Q1040 (**NJM2902V**) is delivered to VHF VCO Q1076 (**2SC5374**) which frequency modulates the transmitting VCO made up of D1049 (**HVC365**). The modulated transmit signal passes through buffer amplifiers Q1077 and Q1078 (both **2SC5374**). The amplified transmit signal is then applied to the Pre-Drive amplifier Q1084 (**2SK2596**) and Driver amplifier Q1086 (**RD07MVS1**), then finally amplified by Power amplifier Q1087 (**RD70HVF1**) up to 50 Watts. This three-stage power amplifier's gain is controlled by the APC circuit. The 50 Watt RF signal passes through high-pass filter and low-pass filter network, antenna switch D1072 and D1073 (both **XB15A709A**), and another low-pass filter network, and then is delivered to the ANT jack.

Circuit Description

UHF Transmit Signal Path

The adjusted speech signal from Q1040 (**NJM2902V**) is delivered to UHF VCO Q1072 (**2SC5006**) which frequency modulates the transmitting VCO made up of D1046 (**HVC375B**). The modulated transmit signal passes through buffer amplifiers Q1073, Q1074, and Q1075 (all **2SC5006**). The filtered transmit signal is then applied to the Pre-Drive amplifier Q1084 (**2SK2596**) and Driver amplifier Q1086 (**RD07MVS1**), then finally amplified by Power amplifier Q1087 (**RD70HVF1**) up to 40 Watts. This three-stage power amplifier's gain is controlled by the APC circuit. The 40 Watt RF signal passes through high-pass filter and low-pass filter networks, antenna switch D1077 (**UM9401F**), and another low-pass filter network, and then is delivered to the ANT jack.

TX APC Circuit

A portion of the power amplifier output is rectified by D1070 and D1071 (UHF: **D1078** and **D1079**, all **MA2S728**), then delivered to APC Q1081 (**NJM2904V**), as a DC voltage which is proportional to the output level of the power amplifier. The APC Q1081 (**NJM2904V**) compares the rectified DC voltage from the power amplifier and the reference voltage from the main CPU Q1065 (**M3826AEFGP**), to produce a control voltage, which regulates supply voltage to the Pre-Drive amplifier Q1084 (**2SK2596**), Drive amplifier Q1086 (**RD07MVS1**) and Power amplifier Q1087 (**RD70HVF1**), so as to maintain stable output power under varying antenna loading conditions.

PTT Circuit

When the PTT switch is pressed, pin 8 of sub CPU Q2001 (**M38223E**) goes "high", which send the "PTT" command to main CPU Q1065 (**M3826AEFGP**). When the CPU receives the "PTT" command, it engages Q1057 (**UMA8N**) and Q1058 (**IMT17**), which activates the Tx circuit.

PLL Circuit

A portion of the output from the VCO Q1076 (**2SC5374**) and Q1072 (**2SC5006**), passes through the programmable divider section of the PLL IC Q1070 (**MB15A02PFV1**), which divides the VCO frequency according to the frequency dividing data that is associated with the current frequency input from the main CPU Q1065 (**M3826AEFGP**). It is then sent to the phase comparator. The 11.15 MHz frequency of the reference oscillator circuit derived from X1002 is divided by the reference frequency divider section of Q1070 (**MB15A02PFV1**) into 4250 or 3400 parts to become 5 kHz or 6.25 kHz comparative reference frequencies, which are utilized by the phase comparator. The phase comparator section of Q1070 (**MB15A02PFV1**) compares the phase between the frequency-divided oscillation frequency of the VCO circuit and the comparative frequency and its output is a pulse corresponding to the phase difference. This pulse is integrated by the charge pump and loop filter of Q1070 (**MB15A02PFV1**) into a control voltage (VCV) to control the oscillation frequency of the VCOs.

Introduction and Precautions

The **FT-7800R** has been carefully aligned at the factory for the specified performance across the 144 MHz and 430 MHz amateur bands. Realignment should therefore not be necessary except in the event of a component failure. All component replacement and service should be performed only by an authorized Vertex Standard representative, or the warranty policy may be voided.

The following procedures cover the sometimes critical and tedious adjustments that are not normally required once the transceiver has left the factory. However, if damage occurs and some parts are replaced, realignment may be required. If a sudden problem occurs during normal operation, it is likely due to component failure; realignment should not be done until after the faulty component has been replaced.

We recommend that servicing be performed only by authorized Vertex Standard service technicians who are experienced with the circuitry and fully equipped for repair and alignment. Therefore, if a fault is suspected, contact the dealer from whom the transceiver was purchased for instructions regarding repair. Authorized Vertex Standard service technicians realign all circuits and make complete performance checks to ensure compliance with factory specifications after replacing any faulty components.

Those who do undertake any of the following alignments are cautioned to proceed at their own risk. Problems caused by unauthorized attempts at realignment are not covered by the warranty policy. Also, Vertex Standard must reserve the right to change circuits and alignment procedures in the interest of improved performance, without notifying owners.

Under no circumstances should any alignment be attempted unless the normal function and operation of the transceiver are clearly understood, the cause of the malfunction has been clearly pinpointed and any faulty components replaced, and the need for realignment determined to be absolutely necessary.

Required Test Equipment

The following test equipment (and thorough familiarity with its correct use) is necessary for complete realignment. Correction of problems caused by misalignment resulting from use of improper test equipment is not covered under the warranty policy. While most steps do not require all of the equipment listed, the interactions of some adjustments may require that more complex adjustments be performed afterwards. Do not attempt to perform only a single step unless it is clearly isolated electrically from all other steps. Have all test equipment ready before beginning, and follow all of the steps in a section in the order presented.

- Regulated DC Power Supply: adjustable from 11.5 to 16 VDC, 10 A
- RF Signal Generator with calibrated output level at 500 MHz
- Frequency Counter: ± 0.1 ppm accuracy at 500 MHz
- AF Signal Generator
- SINAD Meter
- Oscilloscope
- Spectrum Analyzer
- Deviation Meter (linear detector)
- AF Millivoltmeter
- AF Dummy Load: 8-Ohm, 5 W
- DC Voltmeter: high impedance
- Inline Wattmeter with 5% accuracy at 500 MHz
- 50-Ohm non-reactive Dummy Load: 50 watts at 500 MHz
- VHF/UHF Sampling Coupler

Set up the test equipment as shown below, and apply 13.8 VDC power to the transceiver.

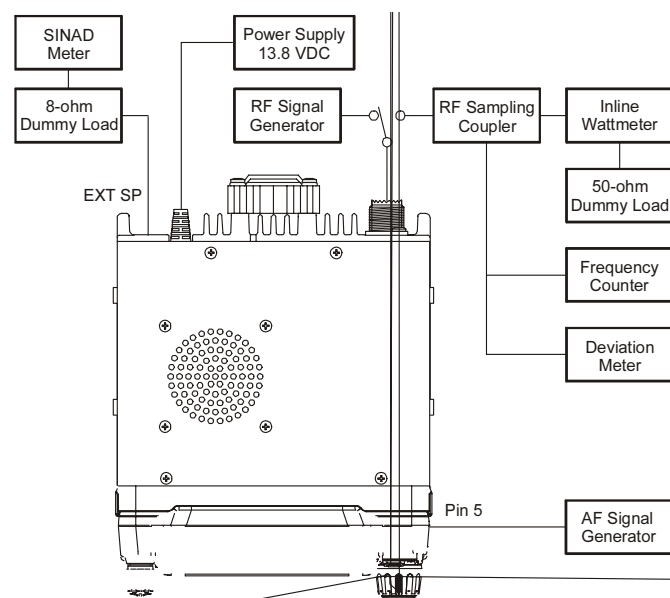

Alignment

Alignment Preparation & Precautions

A dummy load and inline wattmeter must be connected to the main antenna jack in all procedures that call for transmission, except where specified otherwise. Correct alignment is not possible with an antenna. After completing one step, read the following step to determine whether the same test equipment will be required. If not, remove the test equipment (except dummy load and wattmeter, if connected) before proceeding.

Correct alignment requires that the ambient temperature in the repair shop be the same as that of the transceiver and test equipment, and that this temperature be held constant between 68 °C and 86 °F (20 °C ~ 30 °C). When the transceiver is brought into the shop from hot or cold air it should be allowed some time for thermal equalization with the environment before alignment. If possible, alignments should be made with oscillator shields and circuit boards firmly affixed in place. Also, the test equipment must be thoroughly warmed up before beginning.

Notes: Signal levels in dB referred to in alignment are based on 0 dB μ = 0.5 μ V (closed circuit).

Entering the Alignment mode

Alignment of the **FT-7800R** is performed using a front-panel software-based procedure. To perform alignment of the transceiver, it must first be placed in the “Alignment Mode,” in which the adjustments will be made and then stored into memory.

To enter the Alignment mode:

1. Press and hold in the [**MHz(PRI)**] key and the Hyper Memory [**5**] key while turning the radio on. Once the radio is on, release these two keys.
2. Press the front panel keys in the following sequence. [**MHz(PRI)**] → [**TONE(HM/RV)**] → [**LOW(ACC)**] → [**BAND(SET)**] → [**V/M(MW)**] → [**SCAN(SEL)**] → [**S.SCH(ARTS)**]
3. Press and hold in the [**⌘**] key to cause “A-0 REF.xxH” to appear on the display, this signifies that the transceiver is now in the “Alignment mode.”

PLL Reference Frequency

1. Tune the frequency to 435.050 MHz, then set the Transmit Power Level to “LOW.”
2. Press the [**BAND(SET)**] key while pressing and holding in the [**⌘**] key, if needed, to set the Alignment parameter to “A-0 REF.xxH.”
3. Press the **PTT** switch to activate the transmitter, and adjust the **DIAL** knob while pressing and holding the [**⌘**] key, if needed, so that the counter frequency reading is 435.050 MHz (\pm 100 Hz).

RF Front-end Tuning

1. Connect the DC voltmeter to **TP1010** on the MAIN Unit, then inject a 439.050 MHz signal at a level of +10 dB μ (with 1 kHz modulation @ \pm 3.5 kHz deviation) from the RF Signal Generator.
2. Tune the frequency to 439.050 MHz.
3. Press the [**BAND(SET)**] key while pressing and holding the [**⌘**] key to set the Alignment parameter to “A-1 TUN.xxH.”
4. Adjust the **DIAL** knob while pressing and holding in the [**⌘**]

TX Power Output

1. Tune the frequency to 440.050 MHz, then set the Transmit Power Level to “LOW.”
2. Press the [**BAND(SET)**] key while pressing and holding in the [**⌘**] key to set the Alignment parameter to “A-2 PWR.xxH.”
3. Press the **PTT** switch to activate the transmitter, and adjust the **DIAL** knob while pressing and holding in the [**⌘**] key, if needed, so that the wattmeter reading is 5 Watts (± 0.5 Watt).
4. Increase the Transmit Power Level to “MID2.”
5. Press the **PTT** switch to activate the transmitter, and adjust the **DIAL** knob while pressing and holding in the [**⌘**] key, if needed, so that the wattmeter reading is 10 Watts (± 0.5 Watt).
6. Increase the Transmit Power Level to “MID1.”
7. Press the **PTT** switch to activate the transmitter, and adjust the **DIAL** knob while pressing and holding in the [**⌘**] key, if needed, so that the wattmeter reading is 20 Watts (± 0.5 Watt).
8. Increase the Transmit Power Level to “HIGH.”
9. Press the **PTT** switch to activate the transmitter, and adjust the **DIAL** knob while pressing and holding in the [**⌘**] key, if needed, so that the wattmeter reading is 40 Watts (± 0.5 Watt).
10. Tune the frequency to 146.050 MHz, then set the Transmit Power Level to “LOW.”
11. Press the **PTT** switch to activate the transmitter, and adjust the **DIAL** knob while press and holding the [%] key, as needed, so that the wattmeter reading is 5 Watts (± 0.5 Watt).
12. Increase the Transmit Power Level to “MID2.”
13. Press the **PTT** switch to activate the transmitter, and adjust the **DIAL** knob while pressing and holding in the [**⌘**] key, if needed, so that the wattmeter reading is 10 Watts (± 0.5 Watt).
14. Increase the Transmit Power Level to “MID1.”
15. Press the **PTT** switch to activate the transmitter, and adjust the **DIAL** knob while pressing and holding in the [**⌘**] key, if needed, so that the wattmeter reading is 20 Watts (± 0.5 Watt).
16. Increase the Transmit Power Level to “HIGH.”
17. Press the **PTT** switch to activate the transmitter, and adjust the **DIAL** knob while pressing and holding in the [**⌘**] key, if needed, so that the wattmeter reading is 50 Watts (± 0.5 Watt).

TX Deviation

1. Tune the frequency to 440.050 MHz, then set the Transmit Power Level to “LOW.”
2. Press the [**BAND(SET)**] key while pressing and holding in the [**⌘**] key to set the Alignment parameter to “A-3 DEV.xxH.”
3. Inject a 1 kHz audio tone at a level of 80 mV (-20 dBm) from the Audio Generator.
4. Press the **PTT** switch to activate the transmitter, and adjust the **DIAL** knob while pressing and holding in the [**⌘**] key, if needed, so that the deviation meter reading is 4.2 kHz (± 0.2 kHz) (EXP Version: 4.5 kHz (± 0.2 kHz)).
5. Tune the frequency to 146.050 MHz, then set the Transmit Power Level to “LOW.”
6. Press the **PTT** switch to activate the transmitter, and adjust the **DIAL** knob while pressing and holding in the [**⌘**] key, if needed, so that the deviation meter reading is 4.2 kHz (± 0.2 kHz) (EXP Version: 4.5 kHz (± 0.2 kHz)).

DCS TX Deviation

1. Tune the frequency to 440.050 MHz, then activate the DCS with a “023” DCS code, and set the Transmit Power Level to “LOW.”
2. Press the [**BAND(SET)**] key while pressing and holding in the [**⌘**] key to set the Alignment parameter to “A-4 DSC.xxH.”
3. Press the **PTT** switch to activate the transmitter (with no microphone input), and adjust the **DIAL** knob while pressing and holding in the [**⌘**] key, if needed, so that the deviation meter reading is between 0.50 kHz and 0.60 kHz.
4. Tune the frequency to 146.050 MHz, then activate the DCS with a “023” DCS code, and set the Transmit Power Level to “LOW.”
5. Press the **PTT** switch to activate the transmitter (with no microphone input), and adjust the **DIAL** knob while pressing and holding in the [**⌘**] key, if needed, so that the deviation meter reading is between 0.50 kHz and 0.60 kHz.

Alignment

CTCSS TX Deviation

1. Tune the frequency to 440.050 MHz, then activate the CTCSS Encoder with a "100 Hz" tone, and set the Transmit Power Level to "LOW."
2. Press the **[BAND(SET)]** key while press and holding the **[⌘]** key to set the Alignment parameter to "A-5 CTC.xxH."
3. Press the **PTT** switch to activate the transmitter (with no microphone input), and adjust the **DIAL** knob while pressing and holding in the **[⌘]** key, if needed, so that the deviation meter reading is between 0.65 kHz and 0.75 kHz.
4. Tune the frequency to 146.050 MHz, then activate the CTCSS Encoder with a "100 Hz" tone, and set the Transmit Power Level to "LOW."
5. Press the **PTT** switch to activate the transmitter (with no microphone input), and adjust the **DIAL** knob while pressing and holding in the **[⌘]** key, if needed, so that the deviation meter reading is between 0.65 kHz and 0.75 kHz.

Center Meter Sensitivity

1. Tune the frequency to 440.050 MHz.
2. Press the **[BAND(SET)]** key while press and holding the **[⌘]** key to set the Alignment parameter to "A-6 CNTLV."
3. Inject a 1 kHz audio tone at a level of +10 dB μ from the Audio Generator.
4. Press the **[LOW(ACC)]** key while press and holding the **[⌘]** key.

S-Meter Sensitivity

1. Tune the frequency to 440.050 MHz.
2. Press the **[BAND(SET)]** key while press and holding the **[⌘]** key to set the Alignment parameter to "A-7 SMLV."
3. Inject a 440.050 MHz signal at a level of -5 dB μ (with 1 kHz modulation @ \pm 3.5 kHz deviation) from the RF Signal Generator.
4. Press the **[LOW(ACC)]** key while pressing and holding in the **[⌘]** key.
5. Increase the RF Signal Generator output level to +23 dB μ .
6. Press the **[V/M(MW)]** key while pressing and holding in the **[⌘]** key.

7. Tune the frequency to 146.050 MHz.
8. Inject a 146.050 MHz signal at a level of -5 dB μ (with 1 kHz modulation @ \pm 3.5 kHz deviation) from the RF Signal Generator.
9. Press the **[LOW(ACC)]** key while pressing and holding in the **[⌘]** key.
10. Increase the RF Signal Generator output level to +23 dB μ .
11. Press the **[V/M(MW)]** key while pressing and holding in the **[⌘]** key.
12. Tune the frequency to 230.050 MHz.
13. Inject a 230.050 MHz signal at a level of -5 dB μ (with 1 kHz modulation @ \pm 3.5 kHz deviation) from the RF Signal Generator.
14. Press the **[LOW(ACC)]** key while pressing and holding in the **[⌘]** key.
15. Increase the RF Signal Generator output level to +23 dB μ .
16. Press the **[V/M(MW)]** key while pressing and holding in the **[⌘]** key.
17. Tune the frequency to 850.050 MHz.
18. Inject a 850.050 MHz signal at a level of +3 dB μ (with 1 kHz modulation @ \pm 3.5 kHz deviation) from the RF Signal Generator.
19. Press the **[LOW(ACC)]** key while pressing and holding in the **[⌘]** key.
20. Increase the RF Signal Generator output level to +31 dB μ .
21. Press the **[V/M(MW)]** key while pressing and holding in the **[⌘]** key.

DC Voltmeter

1. Set the power supply voltage to 13.8 VDC.
2. Press the **[BAND(SET)]** key while pressing and holding in the **[⌘]** key to set the Alignment parameter to "A-8 BAT SC."
3. Press the **[SCAN(SEL)]** key.

To close the Alignment mode, just press and hold in the **PWR** switch for 0.5 seconds (to turn the power off). The next time the transceiver is turned on, normal operation may resume.

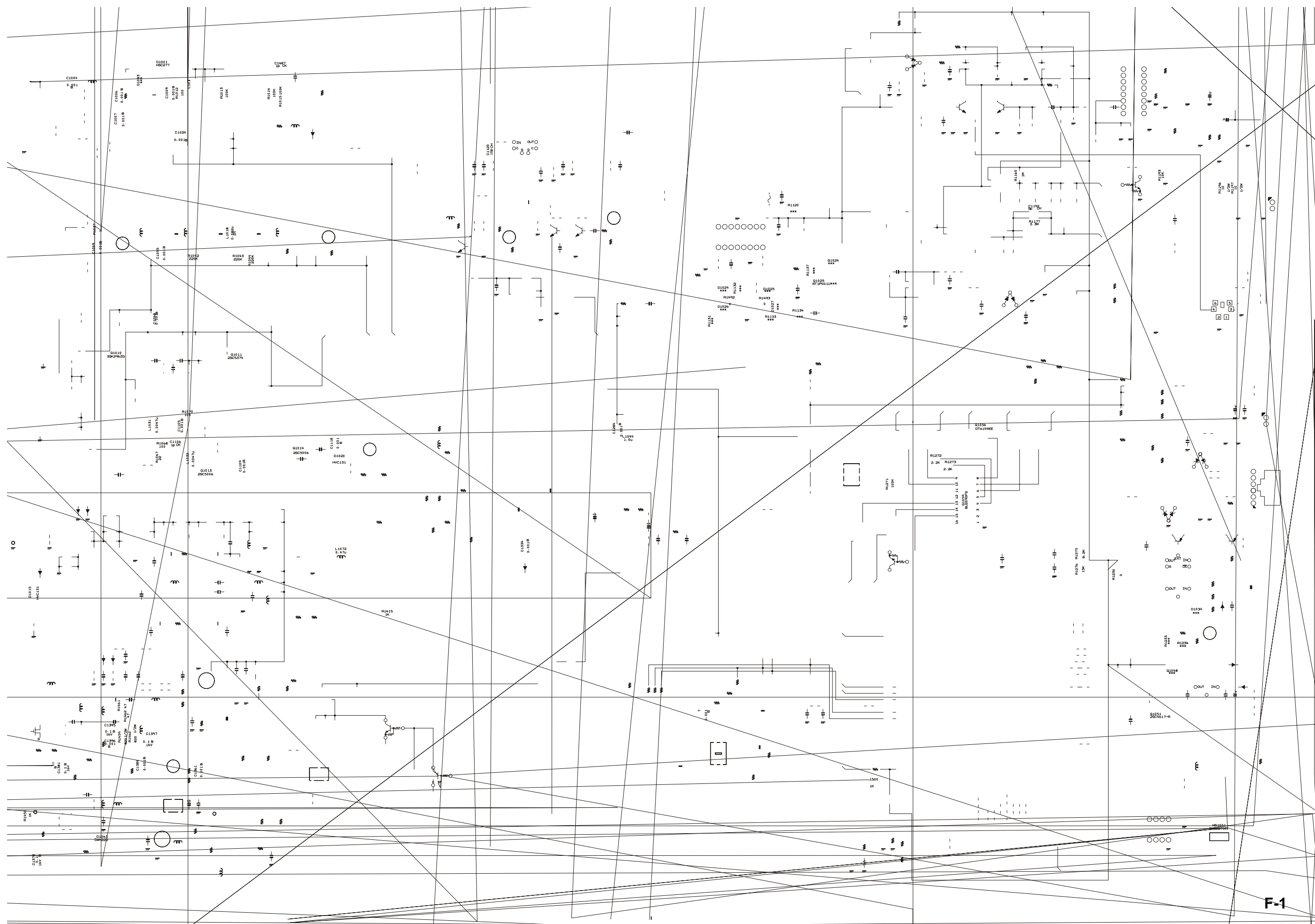

MAIN Unit

Note



MAIN Unit

Parts Layout (Side B)

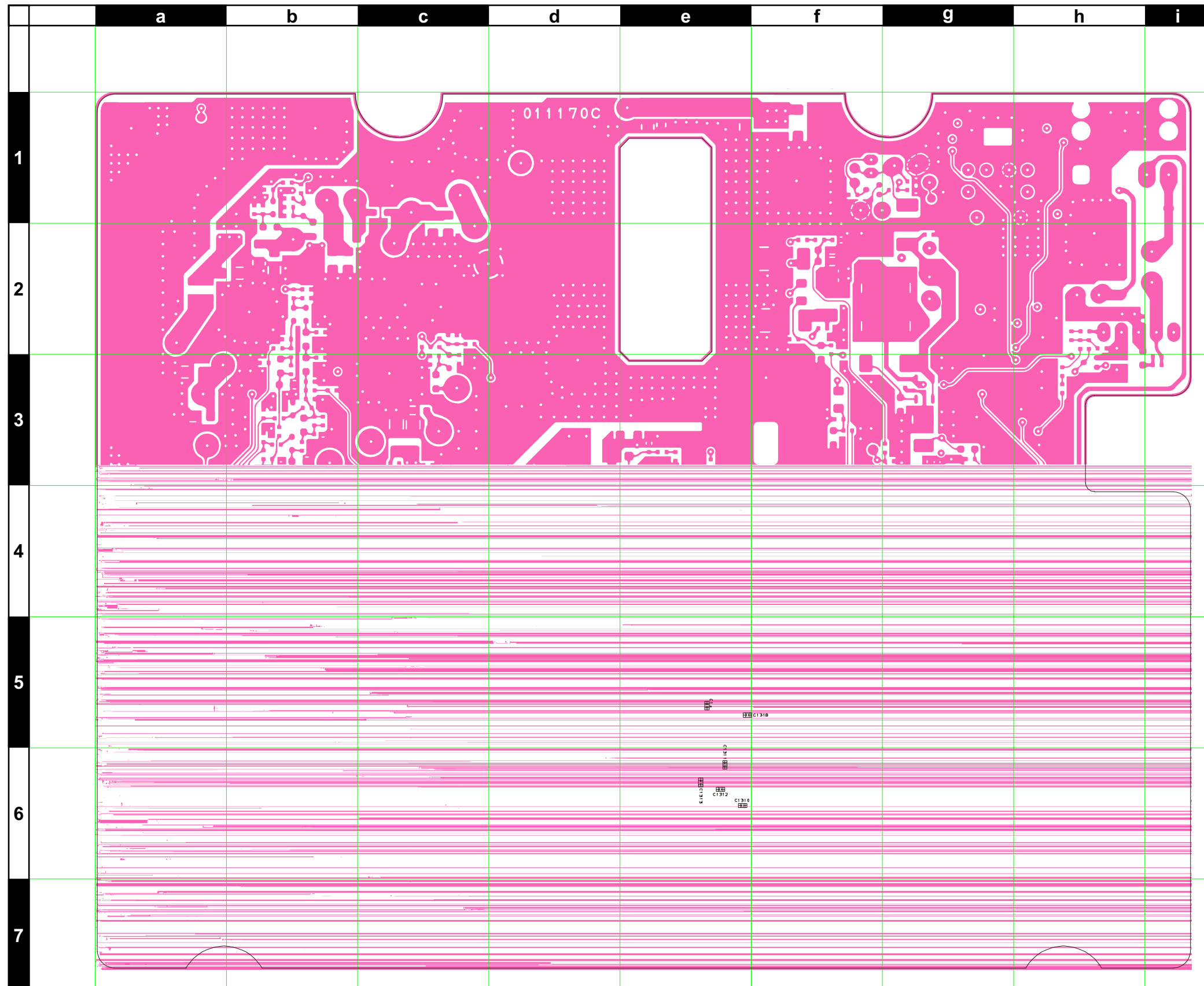

MAIN Unit

Parts List

REF	DESCRIPTION	VALUE	V/W	TOL.	MFR'S DESIG	VXSTD P/N	VERS.	LOT	SIDE	LAY ADR
PCB with Components						CS1803001	USA	A2U		
						CS1803004	EXP	A1		
						CS1803005	EXP	A2		
						CS1803006	EXP	A3		
						CS1803007	EXP	B1		
						CS1803008	EXP	B2		
						CS1803009	EXP	B3		
						CS1803010	EXP	C1		
						CS1803011	EXP	C2		
						CS1803012	EXP	C3		
						CS1803013	EXP	D1		
						CS1803014	EXP	D2		
						CS1803015	AUS	H1		
						CS1803016	AUS	H2		
P.C.B. W/O COMP.					AH016M000	FR011170C		1-		
C 1001	CHIP CAP.	4pF	50V	CH	GRM36CH040B50PT	K22178291		1-	B	c3
C 1002	CHIP CAP.	33pF	50V	CH	GRM36CH330J50PT	K22178224		1-	B	c4
C 1004	CHIP CAP.	0.001uF	50V	B	GRM36B102K50PT	K22178809		1-	B	c4
C 1006	CHIP CAP.	0.001uF	50V	B	GRM36B102K50PT	K22178809		1-	B	c4
C 1007	CHIP CAP.	0.001uF	50V	B	GRM36B102K50PT	K22178809		1-	B	c4
C 1008	CHIP CAP.	0.001uF	50V	B	GRM36B102K50PT	K22178809		1-	B	c4
C 1009	CHIP CAP.	0.001uF	50V	B	GRM36B102K50PT	K22178809		1-	B	c5
C 1010	CHIP CAP.	0.001uF	50V	B	GRM36B102K50PT	K22178809		1-	B	c5
C 1011	CHIP CAP.	68pF	50V	CH	GRM36CH680J50PT	K22178232		1-	B	c4
C 1012	CHIP CAP.	2pF	50V	CK	GRM36CK020B50PT	K22178289		1-	B	c4
C 1013	CHIP CAP.	27pF	50V	CH	GRM36CH270J50PT	K22178222		1-	B	c5
C 1014	CHIP CAP.	0.5pF	50V	CK	GRM36CK0R5B50PT	K22178285		1-	B	c5
C 1015	CHIP CAP.	0.75pF	50V	CK	GRM36CKR75B50PT	K22178286		1-	B	c5
C 1016	CHIP CAP.	2pF	50V	CK	GRM36CK020B50PT	K22178289		1-	B	d5
C 1017	CHIP CAP.	27pF	50V	CH	GRM36CH270J50PT	K22178222		1-	B	d5
C 1018	CHIP CAP.	0.5pF	50V	CK	GRM36CK0R5B50PT	K22178285		1-	B	d5
C 1019	CHIP CAP.	27pF	50V	CH	GRM36CH270J50PT	K22178222		1-	B	d5
C 1021	CHIP CAP.	15pF	50V	CH	GRM36CH150J50PT	K22178216		1-	B	d5
C 1022	CHIP CAP.	0.01uF	16V	B	GRM36B103K16PT	K22128804		1-	B	d4
C 1023	CHIP CAP.	4pF	50V	CH	GRM36CH040B50PT	K22178291		1-	A	E4
C 1024	CHIP CAP.	0.001uF	50V	B	GRM36B102K50PT	K22178809		1-	A	F5
C 1025	CHIP CAP.	6pF	50V	CH	GRM36CH060B50PT	K22178293		1-	A	F5
C 1026	CHIP CAP.	1.5pF	50V	CK	GRM36CK1R5B50PT	K22178288		1-	A	F5
C 1027	CHIP CAP.	6pF	50V	CH	GRM36CH060B50PT	K22178293		1-	A	F5
C 1028	CHIP CAP.	22pF	50V	CH	GRM36CH220J50PT	K22178220		1-	A	E5
C 1029	CHIP CAP.	0.001uF	50V	B	GRM36B102K50PT	K22178809		1-	A	F5
C 1030	CHIP CAP.	1pF	50V	CK	GRM36CK010B50PT	K22178287		1-	A	E5
C 1031	CHIP CAP.	0.001uF	50V	B	GRM36B102K50PT	K22178809		1-	B	d5
C 1032	CHIP CAP.	2pF	50V	CK	GRM36CK020B50PT	K22178289		1-	B	d5
C 1033	CHIP CAP.	0.001uF	50V	B	GRM36B102K50PT	K22178809		1-	B	d5
C 1034	CHIP CAP.	0.001uF	50V	B	GRM36B102K50PT	K22178809		1-	B	d5
C 1035	CHIP CAP.	0.001uF	50V	B	GRM36B102K50PT	K22178809		1-	B	d5
C 1036	CHIP CAP.	27pF	50V	CH	GRM36CH270J50PT	K22178222	AUS	1-	B	b3
C 1036	CHIP CAP.	27pF	50V	CH	GRM36CH270J50PT	K22178222	EXP	1-	B	b3
C 1036	CHIP CAP.	27pF	50V	CH	GRM36CH270J50PT	K22178222	USA	1-	B	b3
C 1037	CHIP CAP.	18pF	50V	CH	GRM36CH180J50PT	K22178218		1-	B	b3
C 1038	CHIP CAP.	12pF	50V	CH	GRM36CH120J50PT	K22178214	AUS	1-	B	b3
C 1038	CHIP CAP.	12pF	50V	CH	GRM36CH120J50PT	K22178214	EXP	1-	B	b3
C 1038	CHIP CAP.	12pF	50V	CH	GRM36CH120J50PT	K22178214	USA	1-	B	b3
C 1039	CHIP CAP.	7pF	50V	CH	GRM36CH070B50PT	K22178294		1-	B	b3
C 1042	CHIP CAP.	22pF	50V	CH	GRM36CH220J50PT	K22178220		1-	B	b3
C 1043	CHIP CAP.	10pF	50V	CH	GRM36CH100B50PT	K22178297	AUS	1-	B	b3
C 1043	CHIP CAP.	10pF	50V	CH	GRM36CH100B50PT	K22178297	EXP	1-	B	b3
C 1043	CHIP CAP.	10pF	50V	CH	GRM36CH100B50PT	K22178297	USA	1-	B	b3
C 1044	CHIP CAP.	4pF	50V	CH	GRM36CH040B50PT	K22178291	AUS	1-	B	b4
C 1044	CHIP CAP.	4pF	50V	CH	GRM36CH040B50PT	K22178291	EXP	1-	B	b4
C 1044	CHIP CAP.	4pF	50V	CH	GRM36CH040B50PT	K22178291	USA	1-	B	b4
C 1045	CHIP CAP.	0.001uF	50V	B	GRM36B102K50PT	K22178809		1-	B	b4
C 1046	CHIP CAP.	8pF	50V	CH	GRM36CH080B50PT	K22178295	AUS	1-	B	b4
C 1046	CHIP CAP.	8pF	50V	CH	GRM36CH080B50PT	K22178295	EXP	1-	B	b4
C 1046	CHIP CAP.	8pF	50V	CH	GRM36CH080B50PT	K22178295	USA	1-	B	b4
C 1047	CHIP CAP.	0.001uF	50V	B	GRM36B102K50PT	K22178809		1-	B	b3
C 1048	CHIP CAP.	6pF	50V	CH	GRM36CH060B50PT	K22178293	AUS	1-	B	b4
C 1048	CHIP CAP.	6pF	50V	CH	GRM36CH060B50PT	K22178293	EXP	1-	B	b4
C 1048	CHIP CAP.	6pF	50V	CH	GRM36CH060B50PT	K22178293	USA	1-	B	b4
C 1049	CHIP CAP.	0.001uF	50V	B	GRM36B102K50PT	K22178809		1-	B	b4
C 1050	CHIP CAP.	0.1uF	10V	B	GRM36B104K10PT	K22108802		1-	B	c4
C 1051	CHIP CAP.	0.001uF	50V	B	GRM36B102K50PT	K22178809		1-	B	c4

MAIN Unit

Parts List

REF	DESCRIPTION	VALUE	V/W	TOL.	MFR'S DESIG	VXSTD P/N	VERS.	LOT	SIDE	LAY ADR
C 1053	CHIP CAP.	8pF	50V	CH	GRM36CH080B50PT	K22178295		1-	B	c5
C 1054	CHIP CAP.	1.5pF	50V	CK	GRM36CK1R5B50PT	K22178288	AUS	1-	B	c5
C 1054	CHIP CAP.	1.5pF	50V	CK	GRM36CK1R5B50PT	K22178288	EXP	1-	B	c5
C 1054	CHIP CAP.	1.5pF	50V	CK	GRM36CK1R5B50PT	K22178288	USA	1-	B	c5
C 1055	CHIP CAP.	0.001uF	50V	B	GRM36B102K50PT	K22178809		1-	B	c5
C 1056	CHIP CAP.	2pF	50V	CK	GRM36CK020B50PT	K22178289	AUS	1-	B	c5
C 1056	CHIP CAP.	2pF	50V	CK	GRM36CK020B50PT	K22178289	EXP	1-	B	c5
C 1056	CHIP CAP.	2pF	50V	CK	GRM36CK020B50PT	K22178289	USA	1-	B	c5
C 1057	CHIP CAP.	47pF	50V	CH	GRM36CH470J50PT	K22178228		1-	B	c5
C 1058	CHIP CAP.	0.75pF	50V	CK	GRM36CKR75B50PT	K22178286		1-	B	c5
C 1059	CHIP CAP.	18pF	50V	CH	GRM36CH180J50PT	K22178218		1-	B	c5
C 1060	CHIP CAP.	0.75pF	50V	CK	GRM36CKR75B50PT	K22178286		1-	B	c5
C 1061	CHIP CAP.	2pF	50V	CK	GRM36CK020B50PT	K22178289		1-	B	c5
C 1062	CHIP CAP.	47pF	50V	CH	GRM36CH470J50PT	K22178228		1-	B	d5
C 1063	CHIP CAP.	8pF	50V	CH	GRM36CH080B50PT	K22178295		1-	B	d5
C 1064	CHIP CAP.	0.5pF	50V	CK	GRM36CK0R5B50PT	K22178285		1-	B	d5
C 1065	CHIP CAP.	1.5pF	50V	CK	GRM36CK1R5B50PT	K22178288	AUS	1-	B	d5
C 1065	CHIP CAP.	1.5pF	50V	CK	GRM36CK1R5B50PT	K22178288	EXP	1-	B	d5
C 1065	CHIP CAP.	1.5pF	50V	CK	GRM36CK1R5B50PT	K22178288	USA	1-	B	d5
C 1066	CHIP CAP.	47pF	50V	CH	GRM36CH470J50PT	K22178228		1-	B	d5
C 1067	CHIP CAP.	0.001uF	50V	B	GRM36B102K50PT	K22178809		1-	A	F5
C 1068	CHIP CAP.	0.001uF	50V	B	GRM36B102K50PT	K22178809		1-	B	d5
C 1069	CHIP CAP.	0.001uF	50V	B	GRM36B102K50PT	K22178809		1-	B	b3
C 1070	CHIP CAP.	15pF	50V	CH	GRM36CH150J50PT	K22178216	AUS	1-	B	d5
C 1070	CHIP CAP.	15pF	50V	CH	GRM36CH150J50PT	K22178216	EXP	1-	B	d5
C 1070	CHIP CAP.	15pF	50V	CH	GRM36CH150J50PT	K22178216	USA	1-	B	d5
C 1071	CHIP CAP.	0.01uF	16V	B	GRM36B103K16PT	K22128804		1-	B	d5
C 1072	CHIP CAP.	0.001uF	50V	B	GRM36B102K50PT	K22178809		1-	B	d5
C 1073	CHIP CAP.	7pF	50V	CH	GRM36CH070B50PT	K22178294		1-	B	d5
C 1074	CHIP CAP.	0.001uF	50V	B	GRM36B102K50PT	K22178809		1-	B	d5
C 1075	CHIP CAP.	2pF	50V	CK	GRM36CK020B50PT	K22178289		1-	B	b3
C 1076	CHIP CAP.	0.001uF	50V	B	GRM36B102K50PT	K22178809		1-	B	b2
C 1077	CHIP CAP.	22pF	50V	CH	GRM36CH220J50PT	K22178220		1-	B	b3
C 1078	CHIP CAP.	6pF	50V	CH	GRM36CH060B50PT	K22178293		1-	B	b3
C 1079	CHIP CAP.	47pF	50V	CH	GRM36CH470J50PT	K22178228		1-	B	b4
C 1080	CHIP CAP.	0.001uF	50V	B	GRM36B102K50PT	K22178809		1-	B	b4
C 1081	CHIP CAP.	0.001uF	50V	B	GRM36B102K50PT	K22178809		1-	B	b4
C 1082	CHIP CAP.	0.001uF	50V	B	GRM36B102K50PT	K22178809		1-	B	b4
C 1084	CHIP CAP.	0.001uF	50V	B	GRM36B102K50PT	K22178809		1-	B	b3
C 1085	CHIP CAP.	0.001uF	50V	B	GRM36B102K50PT	K22178809		1-	B	c5
C 1086	CHIP CAP.	47pF	50V	CH	GRM36CH470J50PT	K22178228		1-	B	c5
C 1087	CHIP CAP.	7pF	50V	CH	GRM36CH070B50PT	K22178294		1-	B	c5
C 1088	CHIP CAP.	2pF	50V	CK	GRM36CK020B50PT	K22178289		1-	B	c5
C 1089	CHIP CAP.	7pF	50V	CH	GRM36CH070B50PT	K22178294		1-	B	c5
C 1090	CHIP CAP.	22pF	50V	CH	GRM36CH220J50PT	K22178220		1-	B	d5
C 1091	CHIP CAP.	0.001uF	50V	B	GRM36B102K50PT	K22178809		1-	B	d5
C 1092	CHIP CAP.	0.5pF	50V	CK	GRM36CK0R5B50PT	K22178285		1-	B	d5
C 1094	CHIP CAP.	0.001uF	50V	B	GRM36B102K50PT	K22178809		1-	B	d5
C 1095	CHIP CAP.	6pF	50V	CH	GRM36CH060B50PT	K22178293		1-	A	E5
C 1097	CHIP CAP.	2pF	50V	CK	GRM36CK020B50PT	K22178289		1-	B	a3
C 1098	CHIP CAP.	47pF	50V	CH	GRM36CH470J50PT	K22178228		1-	B	a4
C 1099	CHIP CAP.	1pF	50V	CK	GRM36CK010B50PT	K22178287		1-	B	a4
C 1100	CHIP CAP.	2pF	50V	CK	GRM36CK020B50PT	K22178289		1-	B	a4
C 1101	CHIP CAP.	6pF	50V	CH	GRM36CH060B50PT	K22178293		1-	B	a4
C 1102	CHIP CAP.	7pF	50V	CH	GRM36CH070B50PT	K22178294		1-	A	H4
C 1103	CHIP CAP.	5pF	50V	CH	GRM36CH050B50PT	K22178292		1-	A	H4
C 1104	CHIP CAP.	12pF	50V	CH	GRM36CH120J50PT	K22178214		1-	A	H5
C 1105	CHIP CAP.	0.001uF	50V	B	GRM36B102K50PT	K22178809		1-	A	H5
C 1106	CHIP CAP.	1pF	50V	CK	GRM36CK010B50PT	K22178287		1-	A	H5
C 1108	CHIP CAP.	8pF	50V	CH	GRM36CH080B50PT	K22178295		1-	A	G5
C 1109	CHIP CAP.	0.001uF	50V	B	GRM36B102K50PT	K22178809		1-	A	F4
C 1110	CHIP CAP.	1pF	50V	CK	GRM36CK010B50PT	K22178287		1-	A	F4
C 1111	CHIP CAP.	1pF	50V	CK	GRM36CK010B50PT	K22178287		1-	A	F5
C 1113	CHIP CAP.	10pF	50V	CH	GRM36CH100D50PT	K22178212		1-	A	F5
C 1114	CHIP CAP.	1pF	50V	CK	GRM36CK010B50PT	K22178287		1-	A	E5
C 1115	CHIP CAP.	0.001uF	50V	B	GRM36B102K50PT	K22178809		1-	A	F5
C 1116	CHIP CAP.	2pF	50V	CK	GRM36CK020B50PT	K22178289		1-	A	E5
C 1117	CHIP CAP.	3pF	50V	CJ	GRM36CJ030B50PT	K22178290		1-	A	E4
C 1118	CHIP CAP.	0.001uF	50V	B	GRM36B102K50PT	K22178809		1-	A	E5
C 1119	CHIP CAP.	0.001uF	50V	B	GRM36B102K50PT	K22178809		1-	A	E6
C 1120	CHIP CAP.	10pF	50V	CH	GRM36CH100B50PT	K22178297		1-	A	F6
C 1121	CHIP CAP.	0.022uF	16V	B	GRM36B223K16PT	K22128806		1-	A	E6
C 1122	CHIP CAP.	6pF	50V	CH	GRM36CH060B50PT	K22178293		1-	A	E6

MAIN Unit

Parts List

REF	DESCRIPTION	VALUE	V/W	TOL.	MFR'S DESIG	VXSTD P/N	VERS.	LOT	SIDE	LAY ADR
C 1123	CHIP CAP.	0.001uF	50V	B	GRM36B102K50PT	K22178809		1-	A	F7
C 1124	CHIP CAP.	0.01uF	16V	B	GRM36B103K16PT	K22128804		1-	A	E7
C 1125	CHIP CAP.	0.01uF	16V	B	GRM36B103K16PT	K22128804		1-	A	E7
C 1126	CHIP CAP.	0.001uF	50V	B	GRM36B102K50PT	K22178809		1-	A	E7
C 1127	CHIP CAP.	0.001uF	50V	B	GRM36B102K50PT	K22178809		1-	B	b5
C 1128	CHIP CAP.	0.1uF	10V	B	GRM36B104K10PT	K22108802		1-	B	f7
C 1129	CHIP CAP.	0.01uF	16V	B	GRM36B103K16PT	K22128804		1-	B	e7
C 1130	CHIP CAP.	0.1uF	10V	B	GRM36B104K10PT	K22108802		1-	B	f7
C 1131	CHIP CAP.	0.1uF	10V	B	GRM36B104K10PT	K22108802		1-	B	f6
C 1132	CHIP CAP.	0.001uF	50V	B	GRM36B102K50PT	K22178809		1-	B	e7
C 1133	CHIP CAP.	0.01uF	16V	B	GRM36B103K16PT	K22128804		1-	A	D7
C 1134	CHIP CAP.	0.01uF	16V	B	GRM36B103K16PT	K22128804		1-	A	D7
C 1135	CHIP CAP.	0.001uF	50V	B	GRM36B102K50PT	K22178809		1-	A	D7
C 1137	CHIP CAP.	0.001uF	50V	B	GRM36B102K50PT	K22178809		1-	B	e6
C 1138	CHIP CAP.	0.001uF	50V	B	GRM36B102K50PT	K22178809		1-	B	g3
C 1139	CHIP CAP.	0.01uF	16V	B	GRM36B103K16PT	K22128804		1-	B	g4
C 1140	CHIP CAP.	0.01uF	16V	B	GRM36B103K16PT	K22128804		1-	B	d7
C 1141	CHIP CAP.	27pF	50V	CH	GRM36CH270J50PT	K22178222		1-	B	d6
C 1142	CHIP CAP.	100pF	50V	CH	GRM36CH101J50PT	K22178236		1-	A	E6
C 1143	CHIP CAP.	1uF	10V	F	GRM39F105Z10PT	K22105001		1-	A	D7
C 1144	CHIP CAP.	22pF	50V	CH	GRM36CH220J50PT	K22178220		1-	A	E7
C 1145	CHIP CAP.	0.1uF	10V	B	GRM36B104K10PT	K22108802		1-	A	E7
C 1146	CHIP CAP.	56pF	50V	CH	GRM36CH560J50PT	K22178230		1-	B	e7
C 1147	CHIP CAP.	56pF	50V	CH	GRM36CH560J50PT	K22178230		1-	A	E7
C 1148	CHIP CAP.	0.01uF	16V	B	GRM36B103K16PT	K22128804		1-	A	E7
C 1149	CHIP CAP.	0.01uF	16V	B	GRM36B103K16PT	K22128804		1-	A	B7
C 1151	CHIP CAP.	0.001uF	50V	B	GRM36B102K50PT	K22178809		1-	A	D7
C 1152	CHIP CAP.	0.001uF	50V	B	GRM36B102K50PT	K22178809		1-	B	e7
C 1153	CHIP CAP.	0.047uF	10V	B	GRM36B473K10PT	K22108801		1-	A	B7
C 1154	CHIP CAP.	220pF	25V	CH	GRM36CH221J25PT	K22148203		1-	B	e7
C 1155	CHIP CAP.	470pF	50V	B	GRM36B471K50PT	K22178805		1-	B	e7
C 1156	CHIP CAP.	470pF	50V	B	GRM36B471K50PT	K22178805		1-	B	e7
C 1157	CHIP CAP.	0.1uF	10V	B	GRM36B104K10PT	K22108802		1-	A	E7
C 1158	CHIP CAP.	0.01uF	16V	B	GRM36B103K16PT	K22128804		1-	B	e6
C 1159	CHIP CAP.	0.01uF	16V	B	GRM36B103K16PT	K22128804		1-	B	e7
C 1160	CHIP TA.CAP.	22uF	6.3V		TEMSVA0J226M-8R	K78080047		1-	B	e7
C 1161	CHIP CAP.	0.01uF	16V	B	GRM36B103K16PT	K22128804		1-	B	e6
C 1162	CHIP CAP.	0.01uF	16V	B	GRM36B103K16PT	K22128804		1-	B	e6
C 1163	CHIP CAP.	0.1uF	10V	B	GRM36B104K10PT	K22108802		1-	B	g5
C 1164	CHIP CAP.	0.1uF	10V	B	GRM36B104K10PT	K22108802		1-	B	g5
C 1165	CHIP CAP.	0.1uF	10V	B	GRM36B104K10PT	K22108802		1-	B	h5
C 1166	CHIP CAP.	0.0022uF	50V	B	GRM36B222K50PT	K22178813		1-	B	h5
C 1168	CHIP CAP.	150pF	50V	CH	GRM36CH151J50PT	K22178240		1-	B	h5
C 1169	CHIP CAP.	1uF	10V	F	GRM39F105Z10PT	K22105001		1-	B	h5
C 1171	CHIP CAP.	0.001uF	50V	B	GRM36B102K50PT	K22178809		1-	B	g5
C 1172	CHIP CAP.	0.0047uF	25V	B	GRM36B472K25PT	K22148830		1-	B	h5
C 1173	CHIP CAP.	0.0047uF	25V	B	GRM36B472K25PT	K22148830		1-	B	h5
C 1174	CHIP CAP.	0.0047uF	25V	B	GRM36B472K25PT	K22148830		1-	B	h5
C 1175	CHIP CAP.	1uF	10V	F	GRM39F105Z10PT	K22105001		1-	A	B4
C 1176	CHIP CAP.	100pF	50V	CH	GRM36CH101J50PT	K22178236		1-	A	B3
C 1177	CHIP CAP.	1uF	10V	F	GRM39F105Z10PT	K22105001		1-	A	B1
C 1178	CHIP CAP.	0.022uF	16V	B	GRM36B223K16PT	K22128806		1-	A	B4
C 1183	CHIP CAP.	0.0033uF	50V	B	GRM36B332K50PT	K22178815	AUS	1-	B	h5
C 1183	CHIP CAP.	0.0033uF	50V	B	GRM36B332K50PT	K22178815	EXP	1-	B	h5
C 1183	CHIP CAP.	0.01uF	16V	B	GRM36B103K16PT	K22128804	USA	1-	B	h5
C 1184	CHIP CAP.	0.01uF	16V	B	GRM36B103K16PT	K22128804	AUS	1-	B	h5
C 1184	CHIP CAP.	0.01uF	16V	B	GRM36B103K16PT	K22128804	EXP	1-	B	h5
C 1184	CHIP CAP.	0.1uF	10V	B	GRM36B104K10PT	K22108802	USA	1-	B	h5
C 1185	CHIP CAP.	0.0047uF	25V	B	GRM36B472K25PT	K22148830	USA	1-	B	h5
C 1186	CHIP CAP.	0.0047uF	25V	B	GRM36B472K25PT	K22148830	USA	1-	B	h5
C 1187	CHIP CAP.	1.5pF	50V	CK	GRM36CK1R5B50PT	K22178288		1-	B	b4
C 1188	CHIP CAP.	1uF	10V	F	GRM39F105Z10PT	K22105001		1-	B	h5
C 1189	CHIP CAP.	0.001uF	50V	B	GRM36B102K50PT	K22178809		1-	B	h5
C 1190	CHIP CAP.	5pF	50V	CH	GRM36CH050B50PT	K22178292		1-	B	h5
C 1191	CHIP CAP.	0.022uF	16V	B	GRM36B223K16PT	K22128806		1-	B	h5
C 1192	CHIP CAP.	0.01uF	16V	B	GRM36B103K16PT	K22128804		1-	B	i5
C 1193	CHIP CAP.	0.0047uF	25V	B	GRM36B472K25PT	K22148830		1-	B	i5
C 1194	CHIP CAP.	680pF	50V	B	GRM36B681K50PT	K22178807		1-	B	i6
C 1195	CHIP CAP.	0.001uF	50V	B	GRM36B102K50PT	K22178809		1-	B	i6
C 1196	CHIP CAP.	0.022uF	16V	B	GRM36B223K16PT	K22128806		1-	B	i6
C 1197	CHIP CAP.	0.0068uF	25V	B	GRM36B682J25PT	K22148803		1-	B	i6
C 1198	CHIP CAP.	330pF	50V	B	GRM36B331K50PT	K22178803		1-	B	i6
C 1199	CHIP CAP.	0.47uF	25V	B	GRM40B474K25PT	K22140824		1-	B	i6

MAIN Unit

Parts List

REF	DESCRIPTION	VALUE	V/W	TOL.	MFR'S DESIG	VXSTD P/N	VERS.	LOT	SIDE	LAY ADR
C 1200	CHIP CAP.	0.0047uF	25V	B	GRM36B472K25PT	K22148830		1-	B	h6
C 1201	CHIP CAP.	0.001uF	50V	B	GRM36B102K50PT	K22178809		1-	A	A5
C 1202	CHIP CAP.	0.1uF	10V	B	GRM36B104K10PT	K22108802		1-	A	B3
C 1203	CHIP CAP.	1uF	10V	F	GRM39F105Z10PT	K22105001		1-	A	A3
C 1204	CHIP CAP.	0.001uF	50V	B	GRM36B102K50PT	K22178809		1-	A	A2
C 1205	CHIP TA.CAP.	10uF	10V		TEMSVA1A106M-8R	K78100028		1-	A	A2
C 1206	CHIP TA.CAP.	10uF	10V		TEMSVA1A106M-8R	K78100028		1-	A	B3
C 1207	CHIP CAP.	0.047uF	10V	B	GRM36B473K10PT	K22108801		1-	A	B3
C 1208	CHIP CAP.	0.001uF	50V	B	GRM36B102K50PT	K22178809		1-	A	A2
C 1209	AL.ELECTRO.CAP.	100uF	16V		16V101M6X7TR2	K46120007		1-	A	A2
C 1210	CHIP CAP.	0.1uF	10V	B	GRM36B104K10PT	K22108802		1-	B	h2
C 1211	AL.ELECTRO.CAP.	220uF	16V		RE2-16V221M 220UF	K40129048		1-	A	A2
C 1212	CHIP CAP.	0.001uF	50V	B	GRM36B102K50PT	K22178809		1-	B	i2
C 1213	CHIP CAP.	0.1uF	16V	B	GRM39B104K16PT	K22124805		1-	B	h3
C 1214	CHIP CAP.	0.001uF	50V	B	GRM36B102K50PT	K22178809		1-	A	A4
C 1215	CHIP CAP.	0.001uF	50V	B	GRM36B102K50PT	K22178809		1-	B	h3
C 1216	CHIP CAP.	0.01uF	16V	B	GRM36B103K16PT	K22128804		1-	B	h6
C 1217	CHIP CAP.	1uF	10V	F	GRM39F105Z10PT	K22105001		1-	A	B1
C 1218	CHIP CAP.	1uF	10V	F	GRM39F105Z10PT	K22105001		1-	A	B1
C 1219	CHIP CAP.	0.015uF	16V	B	GRM36B153K16PT	K22128807		1-	A	B5
C 1220	CHIP CAP.	0.01uF	16V	B	GRM36B103K16PT	K22128804		1-	A	B5
C 1221	CHIP CAP.	0.1uF	10V	B	GRM36B104K10PT	K22108802		1-	A	B5
C 1222	CHIP CAP.	22pF	50V	CH	GRM36CH220J50PT	K22178220		1-	A	B5
C 1223	CHIP CAP.	1uF	10V	F	GRM39F105Z10PT	K22105001		1-	B	h5
C 1224	CHIP CAP.	1uF	10V	F	GRM39F105Z10PT	K22105001		1-	A	A5
C 1225	CHIP CAP.	1uF	10V	F	GRM39F105Z10PT	K22105001		1-	B	f6
C 1227	AL.ELECTRO.CAP.	10uF	16V		16V100M4X7TR2	K46120004		1-	A	C1
C 1228	CHIP CAP.	0.001uF	50V	B	GRM36B102K50PT	K22178809		1-	B	g1
C 1229	CHIP CAP.	0.01uF	16V	B	GRM36B103K16PT	K22128804		1-	B	f1
C 1230	CHIP CAP.	47pF	50V	CH	GRM36CH470J50PT	K22178228		1-	B	f7
C 1231	CHIP CAP.	47pF	50V	CH	GRM36CH470J50PT	K22178228		1-	B	g6
C 1232	CHIP CAP.	47pF	50V	CH	GRM36CH470J50PT	K22178228		1-	B	f6
C 1233	CHIP CAP.	47pF	50V	CH	GRM36CH470J50PT	K22178228		1-	B	f7
C 1234	CHIP CAP.	47pF	50V	CH	GRM36CH470J50PT	K22178228		1-	A	C6
C 1235	AL.ELECTRO.CAP.	100uF	16V		16V101M6X7TR2	K46120007		1-	A	B2
C 1236	CHIP CAP.	0.001uF	50V	B	GRM36B102K50PT	K22178809		1-	B	g2
C 1237	CHIP CAP.	0.022uF	25V	B	GRM39B223K25PT	K22144807		1-	B	g3
C 1238	CHIP TA.CAP.	22uF	16V		TEMSVB21C226M-8R	K78120028		1-	B	g3
C 1239	CHIP CAP.	0.001uF	50V	B	GRM36B102K50PT	K22178809		1-	B	g3
C 1243	CHIP TA.CAP.	10uF	10V		TEMSVA1A106M-8R	K78100028		1-	A	B2
C 1244	CHIP CAP.	0.001uF	50V	B	GRM36B102K50PT	K22178809		1-	A	B3
C 1245	CHIP CAP.	0.022uF	25V	B	GRM39B223K25PT	K22144807		1-	A	B2
C 1246	AL.ELECTRO.CAP.	2200uF	16V		RE3-16V222M 2200UF	K40129064		1-	B	h1
C 1247	CHIP CAP.	0.47uF	25V	B	GRM40B474K25PT	K22140824		1-	A	B1
C 1248	CHIP CAP.	100pF	50V	CH	GRM36CH101J50PT	K22178236		1-	A	B1
C 1249	CHIP CAP.	0.1uF	10V	B	GRM36B104K10PT	K22108802		1-	B	g4
C 1250	CHIP CAP.	0.001uF	50V	B	GRM36B102K50PT	K22178809		1-	B	h4
C 1251	CHIP TA.CAP.	10uF	10V		TEMSVA1A106M-8R	K78100028		1-	B	h4
C 1252	CHIP CAP.	0.1uF	10V	B	GRM36B104K10PT	K22108802		1-	B	h4
C 1253	CHIP CAP.	0.01uF	16V	B	GRM36B103K16PT	K22128804		1-	B	i4
C 1254	CHIP CAP.	0.01uF	16V	B	GRM36B103K16PT	K22128804		1-	B	h4
C 1255	AL.ELECTRO.CAP.	100uF	16V		16V101M6X7TR2	K46120007		1-	A	A4
C 1256	CHIP CAP.	0.001uF	50V	B	GRM36B102K50PT	K22178809		1-	B	i5
C 1257	CHIP CAP.	0.001uF	50V	B	GRM36B102K50PT	K22178809		1-	B	i5
C 1258	CHIP CAP.	0.1uF	10V	B	GRM36B104K10PT	K22108802		1-	B	i5
C 1259	CHIP CAP.	22pF	50V	CH	GRM36CH220J50PT	K22178220		1-	B	h6
C 1260	CHIP CAP.	3pF	50V	CJ	GRM36CJ030B50PT	K22178290		1-	B	h6
C 1261	CHIP CAP.	10pF	50V	CH	GRM36CH100D50PT	K22178212		1-	B	h6
C 1262	CHIP CAP.	0.001uF	50V	B	GRM36B102K50PT	K22178809		1-	B	h6
C 1263	CHIP CAP.	15pF	50V	CH	GRM36CH150J50PT	K22178216		1-	A	A5
C 1264	CHIP CAP.	0.1uF	10V	B	GRM36B104K10PT	K22108802		1-	A	A5
C 1265	CHIP CAP.	470pF	50V	B	GRM36B471K50PT	K22178805		1-	A	A5
C 1266	CHIP CAP.	0.001uF	50V	B	GRM36B102K50PT	K22178809		1-	A	A5
C 1267	CHIP CAP.	39pF	50V	CH	GRM36CH390J50PT	K22178226		1-	A	A5
C 1268	CHIP CAP.	0.0012uF	50V	B	GRM36B122K50PT	K22178810		1-	A	B5
C 1269	CHIP CAP.	0.1uF	10V	B	GRM36B104K10PT	K22108802		1-	A	B6
C 1270	CHIP CAP.	0.0047uF	25V	B	GRM36B472K25PT	K22148830		1-	B	h6
C 1271	CHIP CAP.	0.001uF	50V	B	GRM36B102K50PT	K22178809		1-	A	B5
C 1272	CHIP CAP.	47pF	50V	CH	GRM36CH470J50PT	K22178228		1-	A	B5
C 1274	CHIP TA.CAP.	10uF	10V		TEMSVA1A106M-8R	K78100028		1-	A	F7
C 1277	CHIP CAP.	0.001uF	50V	B	GRM36B102K50PT	K22178809		1-	A	E7
C 1278	CHIP TA.CAP.	10uF	10V		TEMSVA1A106M-8R	K78100028		1-	A	F6
C 1279	CHIP CAP.	0.001uF	50V	B	GRM36B102K50PT	K22178809		1-	B	h7

MAIN Unit

Parts List

REF	DESCRIPTION	VALUE	V/W	TOL.	MFR'S DESIG	VXSTD P/N	VERS.	LOT	SIDE	LAY ADR
C 1280	CHIP CAP.	0.001uF	50V	B	GRM36B102K50PT	K22178809		1-	A	C4
C 1281	CHIP CAP.	1uF	10V	F	GRM39F105Z10PT	K22105001		1-	A	B5
C 1283	CHIP CAP.	47pF	50V	CH	GRM36CH470J50PT	K22178228		1-	B	d6
C 1284	CHIP CAP.	0.001uF	50V	B	GRM36B102K50PT	K22178809		1-	B	d6
C 1285	CHIP CAP.	1pF	50V	CK	GRM36CK010B50PT	K22178287		1-	B	e6
C 1286	CHIP CAP.	0.022uF	16V	B	GRM36B223K16PT	K22128806		1-	B	h6
C 1287	CHIP CAP.	1uF	10V	B	GRM40B105K10PT(0.85)	K22100803		1-	B	f6
C 1288	CHIP CAP.	0.022uF	16V	B	GRM36B223K16PT	K22128806		1-	A	D5
C 1289	CHIP CAP.	0.1uF	16V	B	GRM39B104K16PT	K22124805		1-	A	D5
C 1290	CHIP TA.CAP.	10uF	10V		TEMSVA1A106M-8R	K78100028		1-	A	D5
C 1291	CHIP CAP.	0.1uF	16V	B	GRM39B104K16PT	K22124805		1-	A	D5
C 1292	CHIP CAP.	33pF	50V	CH	GRM36CH330J50PT	K22178224		1-	A	C6
C 1293	CHIP CAP.	33pF	50V	CH	GRM36CH330J50PT	K22178224		1-	A	D6
C 1294	CHIP CAP.	33pF	50V	CH	GRM36CH330J50PT	K22178224		1-	A	D6
C 1295	CHIP CAP.	0.001uF	50V	B	GRM36B102K50PT	K22178809		1-	A	D5
C 1296	CHIP CAP.	0.01uF	16V	B	GRM36B103K16PT	K22128804		1-	A	D6
C 1297	CHIP CAP.	0.001uF	50V	B	GRM39B102K50PT	K22174821		1-	A	D5
C 1298	CHIP TA.CAP.	10uF	10V		TEMSVA1A106M-8R	K78100028		1-	A	D6
C 1299	CHIP CAP.	0.0022uF	50V	B	GRM36B222K50PT	K22178813		1-	A	D5
C 1300	CHIP CAP.	0.047uF	10V	B	GRM36B473K10PT	K22108801		1-	A	D6
C 1301	CHIP CAP.	47pF	50V	UJ	GRP1553U1H470JZ01E	K22178319		1-	B	f6
C 1302	CHIP CAP.	6pF	50V	UJ	GRP1553U1H6R0DZ01E	K22178307		1-	B	f6
C 1303	CHIP CAP.	0.01uF	16V	B	GRM36B103K16PT	K22128804		1-	B	f6
C 1304	CHIP CAP.	0.1uF	10V	B	GRM36B104K10PT	K22108802		1-	B	g6
C 1305	CHIP CAP.	0.1uF	10V	B	GRM36B104K10PT	K22108802		1-	B	g6
C 1306	CHIP CAP.	1uF	10V	B	GRM40B105K10PT(0.85)	K22100803		1-	B	f6
C 1307	CHIP CAP.	0.01uF	16V	B	GRM36B103K16PT	K22128804		1-	B	f6
C 1308	CHIP CAP.	100pF	50V	UJ	GRP1553U1H101JZ01E	K22178323		1-	B	f6
C 1309	CHIP CAP.	0.01uF	16V	B	GRM36B103K16PT	K22128804		1-	B	f6
C 1310	CHIP CAP.	27pF	50V	UJ	GRP1553U1H270JZ01E	K22178316		1-	B	e6
C 1311	CHIP CAP.	3pF	50V	UJ	GRP1553U1H3R0CZ01E	K22178304		1-	B	e6
C 1312	CHIP CAP.	270pF	25V	CH	GRM36CH271J25PT	K22148248		1-	B	e6
C 1313	CHIP CAP.	0.001uF	50V	B	GRM36B102K50PT	K22178809		1-	B	e6
C 1314	CHIP CAP.	0.1uF	10V	B	GRM36B104K10PT	K22108802		1-	A	D6
C 1315	CHIP TA.CAP.	10uF	10V		TEMSVA1A106M-8R	K78100028		1-	A	D6
C 1316	CHIP CAP.	0.1uF	10V	B	GRM36B104K10PT	K22108802		1-	A	D6
C 1317	CHIP CAP.	0.001uF	50V	B	GRM36B102K50PT	K22178809		1-	A	E5
C 1318	CHIP CAP.	0.001uF	50V	B	GRM36B102K50PT	K22178809		1-	B	e5
C 1319	CHIP CAP.	0.001uF	50V	B	GRM36B102K50PT	K22178809		1-	B	e5
C 1320	CHIP CAP.	0.001uF	50V	B	GRM36B102K50PT	K22178809		1-	B	f5
C 1321	CHIP CAP.	0.001uF	50V	B	GRM39B102K50PT	K22174821		1-	B	e5
C 1322	CHIP CAP.	20pF	50V	CH	GRM36CH200J50PT	K22178219		1-	B	e5
C 1323	CHIP CAP.	18pF	50V	CH	GRM36CH180J50PT	K22178218		1-	B	e5
C 1324	CHIP CAP.	10pF	50V	CH	GRM36CH100D50PT	K22178212		1-	B	f5
C 1325	CHIP CAP.	1pF	50V	CK	GRM36CK010B50PT	K22178287		1-	B	e5
C 1326	CHIP CAP.	0.001uF	50V	B	GRM36B102K50PT	K22178809		1-	B	e5
C 1327	CHIP CAP.	0.001uF	50V	B	GRM36B102K50PT	K22178809		1-	B	e5
C 1328	CHIP CAP.	3pF	50V	CJ	GRM36CJ030B50PT	K22178290		1-	A	D5
C 1329	CHIP CAP.	0.001uF	50V	B	GRM36B102K50PT	K22178809		1-	B	e5
C 1330	CHIP TA.CAP.	0.1uF	20V		SKF-1D104M-RP	K78130049		1-	A	D5
C 1331	CHIP CAP.	22pF	50V	CH	GRM36CH220J50PT	K22178220		1-	A	E5
C 1332	CHIP CAP.	0.001uF	50V	B	GRM36B102K50PT	K22178809		1-	B	e5
C 1333	CHIP CAP.	0.001uF	50V	B	GRM36B102K50PT	K22178809		1-	A	D5
C 1334	CHIP CAP.	0.001uF	50V	B	GRM36B102K50PT	K22178809		1-	B	e5
C 1335	CHIP CAP.	47pF	50V	CH	GRM36CH470J50PT	K22178228		1-	B	e5
C 1336	CHIP CAP.	0.001uF	50V	B	GRM39B102K50PT	K22174821		1-	B	e5
C 1337	CHIP CAP.	22pF	50V	CH	GRM36CH220J50PT	K22178220		1-	B	e5
C 1338	CHIP CAP.	18pF	50V	CH	GRM36CH180J50PT	K22178218		1-	B	e5
C 1339	CHIP CAP.	2pF	50V	CK	GRM36CK020B50PT	K22178289		1-	B	e5
C 1340	CHIP CAP.	0.001uF	50V	B	GRM36B102K50PT	K22178809		1-	A	E5
C 1341	CHIP CAP.	0.001uF	50V	B	GRM36B102K50PT	K22178809		1-	B	e5
C 1342	CHIP CAP.	2pF	50V	CK	GRM36CK020B50PT	K22178289		1-	A	D5
C 1343	CHIP CAP.	0.001uF	50V	B	GRM36B102K50PT	K22178809		1-	A	D5
C 1345	CHIP CAP.	0.001uF	50V	B	GRM39B102K50PT	K22174821		1-	A	E4
C 1346	CHIP CAP.	0.1uF	10V	B	GRM36B104K10PT	K22108802		1-	B	g4
C 1347	CHIP CAP.	0.001uF	50V	B	GRM36B102K50PT	K22178809		1-	B	g3
C 1348	CHIP CAP.	0.001uF	50V	B	GRM36B102K50PT	K22178809		1-	B	g3
C 1349	CHIP CAP.	0.01uF	16V	B	GRM36B103K16PT	K22128804		1-	B	g4
C 1350	CHIP CAP.	0.001uF	50V	B	GRM36B102K50PT	K22178809		1-	B	g3
C 1351	CHIP TA.CAP.	10uF	10V		TEMSVA1A106M-8R	K78100028		1-	B	g4
C 1353	CHIP CAP.	0.001uF	50V	B	GRM36B102K50PT	K22178809		1-	B	g3
C 1354	CHIP CAP.	0.001uF	50V	B	GRM36B102K50PT	K22178809		1-	B	e4
C 1355	CHIP CAP.	0.001uF	50V	B	GRM36B102K50PT	K22178809		1-	B	e4

MAIN Unit

Parts List

REF	DESCRIPTION	VALUE	V/W	TOL.	MFR'S DESIG	VXSTD P/N	VERS.	LOT	SIDE	LAY ADR
C 1356	CHIP CAP.	0.001uF	50V	B	GRM36B102K50PT	K22178809		1-	A	E4
C 1358	CHIP CAP.	0.001uF	50V	B	GRM36B102K50PT	K22178809		1-	A	E4
C 1359	CHIP CAP.	7pF	50V	CH	GRM36CH070B50PT	K22178294		1-	B	e4
C 1361	CHIP CAP.	0.001uF	50V	B	GRM36B102K50PT	K22178809		1-	B	e3
C 1362	CHIP CAP.	0.001uF	50V	B	GRM36B102K50PT	K22178809		1-	B	e3
C 1363	CHIP TA.CAP.	22uF	16V		TEMSVB21C226M-8R	K78120028		1-	B	d3
C 1364	CHIP CAP.	0.001uF	50V	B	GRM36B102K50PT	K22178809		1-	B	f4
C 1365	CHIP CAP.	100pF	50V	CH	GRM36CH101J50PT	K22178236		1-	B	e4
C 1366	CHIP CAP.	18pF	50V	CH	GRM36CH180J50PT	K22178218		1-	A	D4
C 1367	CHIP CAP.	0.01uF	16V	B	GRM36B103K16PT	K22128804		1-	B	f4
C 1369	CHIP CAP.	0.47uF	25V	B	GRM40B474K25PT	K22140824		1-	B	e4
C 1370	CHIP CAP.	0.022uF	25V	B	GRM39B223K25PT	K22144807		1-	B	e4
C 1371	CHIP CAP.	0.001uF	50V	B	GRM36B102K50PT	K22178809		1-	B	e4
C 1373	CHIP CAP.	8pF	50V	CH	GRM36CH080B50PT	K22178295		1-	A	D4
C 1374	CHIP CAP.	12pF	50V	CH	GRM36CH120J50PT	K22178214		1-	A	D4
C 1375	CHIP CAP.	68pF	50V	CH	GRM36CH680J50PT	K22178232		1-	A	D4
C 1376	CHIP CAP.	82pF	50V	CH	GRM36CH820J50PT	K22178234		1-	A	D4
C 1377	CHIP CAP.	0.001uF	50V	B	GRM36B102K50PT	K22178809		1-	A	D3
C 1378	CHIP CAP.	0.1uF	16V	B	GRM39B104K16PT	K22124805		1-	A	D3
C 1379	CHIP CAP.	0.001uF	50V	B	GRM36B102K50PT	K22178809		1-	A	D3
C 1380	CHIP CAP.	0.001uF	50V	B	GRM36B102K50PT	K22178809		1-	A	E4
C 1381	CHIP CAP.	0.1uF	16V	B	GRM39B104K16PT	K22124805		1-	A	E4
C 1382	CHIP CAP.	0.001uF	50V	B	GRM36B102K50PT	K22178809		1-	B	e4
C 1383	CHIP CAP.	0.1uF	16V	B	GRM39B104K16PT	K22124805		1-	B	e4
C 1384	CHIP CAP.	0.001uF	50V	B	GRM36B102K50PT	K22178809		1-	B	f2
C 1385	CHIP CAP.	0.001uF	50V	B	GRM39B102K50PT	K22174821		1-	A	B3
C 1386	CHIP CAP.	0.47uF	25V	B	GRM40B474K25PT	K22140824		1-	A	B4
C 1387	CHIP CAP.	0.022uF	25V	B	GRM39B223K25PT	K22144807		1-	A	C4
C 1388	CHIP CAP.	0.001uF	50V	B	GRM39B102K50PT	K22174821		1-	A	C4
C 1389	CHIP CAP.	0.47uF	25V	B	GRM40B474K25PT	K22140824		1-	A	C4
C 1390	CHIP CAP.	10pF	50V	CH	GRM39CH100D50PT	K22174211		1-	A	C3
C 1391	CHIP CAP.	10pF	50V	CH	GRM39CH100D50PT	K22174211		1-	A	D3
C 1392	CHIP CAP.	10pF	50V	CH	GRM39CH100D50PT	K22174211		1-	A	C3
C 1393	CHIP CAP.	10pF	50V	CH	GRM39CH100D50PT	K22174211		1-	A	C3
C 1394	CHIP CAP.	33pF	50V	CH	GRM39CH330J50PT	K22174223		1-	A	C2
C 1395	CHIP CAP.	0.1uF	16V	B	GRM39B104K16PT	K22124805		1-	B	f3
C 1396	CHIP CAP.	0.001uF	50V	B	GRM36B102K50PT	K22178809		1-	B	f3
C 1397	CHIP CAP.	0.1uF	16V	B	GRM39B104K16PT	K22124805		1-	B	f2
C 1398	CHIP CAP.	33pF	50V	CH	GRM39CH330J50PT	K22174223		1-	A	C3
C 1399	CHIP CAP.	15pF	50V	CH	GRM39CH150J50PT	K22174215		1-	A	C3
C 1400	CHIP CAP.	22pF	50V	CH	GRM39CH220J50PT	K22174219		1-	A	C3
C 1401	CHIP CAP.	10pF	50V	CH	GRM39CH100D50PT	K22174211		1-	A	C3
C 1403	CHIP CAP.	150pF	50V	CH	GRM39CH151J50PT	K22174239	USA A2	1-	A	C2
C 1403	CHIP CAP.	150pF	50V	CH	GRM39CH151J50PT	K22174239	VER. A1	1-	A	C2
C 1403	CHIP CAP.	150pF	50V	CH	GRM39CH151J50PT	K22174239	VER. A2	1-	A	C2
C 1403	CHIP CAP.	150pF	50V	CH	GRM39CH151J50PT	K22174239	VER. A3	1-	A	C2
C 1403	CHIP CAP.	150pF	50V	CH	GRM39CH151J50PT	K22174239	VER. B1	1-	A	C2
C 1403	CHIP CAP.	150pF	50V	CH	GRM39CH151J50PT	K22174239	VER. B2	1-	A	C2
C 1403	CHIP CAP.	150pF	50V	CH	GRM39CH151J50PT	K22174239	VER. B3	1-	A	C2
C 1403	CHIP CAP.	150pF	50V	CH	GRM39CH151J50PT	K22174239	VER. C1	1-	A	C2
C 1403	CHIP CAP.	150pF	50V	CH	GRM39CH151J50PT	K22174239	VER. C2	1-	A	C2
C 1403	CHIP CAP.	150pF	50V	CH	GRM39CH151J50PT	K22174239	VER. C3	1-	A	C2
C 1403	CHIP CAP.	150pF	50V	CH	GRM39CH151J50PT	K22174239	VER. D1	1-	A	C2
C 1403	CHIP CAP.	150pF	50V	CH	GRM39CH151J50PT	K22174239	VER. C1	1-	A	C2
C 1403	CHIP CAP.	150pF	50V	CH	GRM39CH151J50PT	K22174239	VER. C2	1-	A	C2
C 1403	CHIP CAP.	150pF	50V	CH	GRM39CH151J50PT	K22174239	VER. C3	1-	A	C2
C 1403	CHIP CAP.	150pF	50V	CH	GRM39CH151J50PT	K22174239	VER. D1	1-	A	C2
C 1403	CHIP CAP.	150pF	50V	CH	GRM39CH151J50PT	K22174239	VER. D2	1-	A	C2
C 1403	CHIP CAP.	150pF	50V	CH	GRM39CH151J50PT	K22174239	VER. H1	1-	A	C2
C 1403	CHIP CAP.	150pF	50V	CH	GRM39CH151J50PT	K22174239	VER. H2	1-	A	C2
C 1404	FILM CAP.	47pF	500V		UC232H0470J-T	K33279034		1-	A	C2
C 1405	CHIP CAP.	15pF	50V	CH	GRM39CH150J50PT	K22174215		1-	A	D2
C 1406	CHIP CAP.	0.1uF	16V	B	GRM39B104K16PT	K22124805		1-	B	f2
C 1407	CHIP CAP.	0.001uF	50V	B	GRM39B102K50PT	K22174821		1-	B	f2
C 1408	FILM CAP.	47pF	500V		UC232H0470J-T	K33279034		1-	A	D2
C 1410	FILM CAP.	47pF	500V		UC232H0470J-T	K33279034		1-	A	D1
C 1411	CHIP CAP.	0.001uF	50V	B	GRM36B102K50PT	K22178809		1-	A	G2
C 1412	CHIP CAP.	0.01uF	16V	B	GRM36B103K16PT	K22128804		1-	A	G2
C 1413	CHIP CAP.	33pF	50V	CH	GRM36CH330J50PT	K22178224		1-	A	C2
C 1414	CHIP CAP.	56pF	50V	CH	GRM36CH560J50PT	K22178230	USA A2	1-	A	C2
C 1414	CHIP CAP.	56pF	50V	CH	GRM36CH560J50PT	K22178230	VER. A1	1-	A	C2
C 1414	CHIP CAP.	56pF	50V	CH	GRM36CH560J50PT	K22178230	VER. A2	1-	A	C2
C 1414	CHIP CAP.	56pF	50V	CH	GRM36CH560J50PT	K22178230	VER. A3	1-	A	C2
C 1414	CHIP CAP.	56pF	50V	CH	GRM36CH560J50PT	K22178230	VER. B1	1-	A	C2
C 1414	CHIP CAP.	56pF	50V	CH	GRM36CH560J50PT	K22178230	VER. B2	1-	A	C2
C 1414	CHIP CAP.	56pF	50V	CH	GRM36CH560J50PT	K22178230	VER. B3	1-	A	C2
C 1414	CHIP CAP.	56pF	50V	CH	GRM36CH560J50PT	K22178230	VER. C1	1-	A	C2

MAIN Unit

Parts List

REF	DESCRIPTION	VALUE	V/W	TOL.	MFR'S DESIG	VXSTD P/N	VERS.	LOT	SIDE	LAY ADR
C 1414	CHIP CAP.	56pF	50V	CH	GRM36CH560J50PT	K22178230	VER. C2	1-	A	C2
C 1414	CHIP CAP.	56pF	50V	CH	GRM36CH560J50PT	K22178230	VER. C3	1-	A	C2
C 1414	CHIP CAP.	56pF	50V	CH	GRM36CH560J50PT	K22178230	VER. D1	1-	A	C2
C 1414	CHIP CAP.	56pF	50V	CH	GRM36CH560J50PT	K22178230	VER. D2	1-	A	C2
C 1414	CHIP CAP.	56pF	50V	CH	GRM36CH560J50PT	K22178230	VER. H1	1-	A	C2
C 1414	CHIP CAP.	56pF	50V	CH	GRM36CH560J50PT	K22178230	VER. H2	1-	A	C2
C 1415	CHIP CAP.	0.001uF	50V	B	GRM36B102K50PT	K22178809	USA A2	1-	A	C2
C 1415	CHIP CAP.	0.001uF	50V	B	GRM36B102K50PT	K22178809	VER. A1	1-	A	C2
C 1415	CHIP CAP.	0.001uF	50V	B	GRM36B102K50PT	K22178809	VER. A2	1-	A	C2
C 1415	CHIP CAP.	0.001uF	50V	B	GRM36B102K50PT	K22178809	VER. A3	1-	A	C2
C 1415	CHIP CAP.	0.001uF	50V	B	GRM36B102K50PT	K22178809	VER. B1	1-	A	C2
C 1415	CHIP CAP.	0.001uF	50V	B	GRM36B102K50PT	K22178809	VER. B2	1-	A	C2
C 1415	CHIP CAP.	0.001uF	50V	B	GRM36B102K50PT	K22178809	VER. B3	1-	A	C2
C 1415	CHIP CAP.	0.001uF	50V	B	GRM36B102K50PT	K22178809	VER. C1	1-	A	C2
C 1415	CHIP CAP.	0.001uF	50V	B	GRM36B102K50PT	K22178809	VER. C2	1-	A	C2
C 1415	CHIP CAP.	0.001uF	50V	B	GRM36B102K50PT	K22178809	VER. C3	1-	A	C2
C 1415	CHIP CAP.	0.001uF	50V	B	GRM36B102K50PT	K22178809	VER. D1	1-	A	C2
C 1415	CHIP CAP.	0.001uF	50V	B	GRM36B102K50PT	K22178809	VER. D2	1-	A	C2
C 1415	CHIP CAP.	0.001uF	50V	B	GRM36B102K50PT	K22178809	VER. H1	1-	A	C2
C 1415	CHIP CAP.	0.001uF	50V	B	GRM36B102K50PT	K22178809	VER. H2	1-	A	C2
C 1416	CHIP CAP.	0.001uF	50V	B	GRM36B102K50PT	K22178809	USA A2	1-	A	C2
C 1416	CHIP CAP.	0.001uF	50V	B	GRM36B102K50PT	K22178809	VER. A1	1-	A	C2
C 1416	CHIP CAP.	0.001uF	50V	B	GRM36B102K50PT	K22178809	VER. A2	1-	A	C2
C 1416	CHIP CAP.	0.001uF	50V	B	GRM36B102K50PT	K22178809	VER. A3	1-	A	C2
C 1416	CHIP CAP.	0.001uF	50V	B	GRM36B102K50PT	K22178809	VER. B1	1-	A	C2
C 1416	CHIP CAP.	0.001uF	50V	B	GRM36B102K50PT	K22178809	VER. B2	1-	A	C2
C 1416	CHIP CAP.	0.001uF	50V	B	GRM36B102K50PT	K22178809	VER. B3	1-	A	C2
C 1416	CHIP CAP.	0.001uF	50V	B	GRM36B102K50PT	K22178809	VER. C1	1-	A	C2
C 1416	CHIP CAP.	0.001uF	50V	B	GRM36B102K50PT	K22178809	VER. C2	1-	A	C2
C 1416	CHIP CAP.	0.001uF	50V	B	GRM36B102K50PT	K22178809	VER. C3	1-	A	C2
C 1416	CHIP CAP.	0.001uF	50V	B	GRM36B102K50PT	K22178809	VER. D1	1-	A	C2
C 1416	CHIP CAP.	0.001uF	50V	B	GRM36B102K50PT	K22178809	VER. D2	1-	A	C2
C 1416	CHIP CAP.	0.001uF	50V	B	GRM36B102K50PT	K22178809	VER. H1	1-	A	C2
C 1416	CHIP CAP.	0.001uF	50V	B	GRM36B102K50PT	K22178809	VER. H2	1-	A	C2
C 1417	CHIP TA.CAP.	1uF	25V		TEMSVA1E105M-8R	K78140013		1-	B	f1
C 1418	CHIP CAP.	0.47uF	25V	B	GRM40B474K25PT	K22140824		1-	B	e1
C 1419	CHIP CAP.	0.001uF	50V	B	GRM39B102K50PT	K22174821		1-	B	e1
C 1420	CHIP CAP.	100pF	200V	CH	GRM40CH101J200PT	K22230228		1-	B	e1
C 1421	FILM CAP.	47pF	500V		UC232H0470J-T	K33279034		1-	A	E1
C 1422	FILM CAP.	47pF	500V		UC232H0470J-T	K33279034		1-	A	E2
C 1424	CHIP CAP.	0.001uF	50V	B	GRM36B102K50PT	K22178809		1-	B	a3
C 1425	CHIP CAP.	5pF	200V	CH	GRM188C2DR50CY01D	K22234207		1-	A	F2
C 1426	FILM CAP.	56pF	500V		UC232H0560J-T	K33279035		1-	A	F1
C 1427	FILM CAP.	56pF	500V		UC232H0560J-T	K33279035		1-	A	F2
C 1428	CHIP CAP.	27pF	200V	CH	GRM40CH270J200PT	K22230221		1-	B	c2
C 1429	CHIP CAP.	27pF	200V	CH	GRM40CH270J200PT	K22230221		1-	B	c2
C 1431	CHIP CAP.	220pF	200V	CH	GRM40CH221J200PT	K22230232		1-	B	b2
C 1432	CHIP CAP.	220pF	200V	CH	GRM40CH221J200PT	K22230232		1-	B	b1
C 1433	CHIP CAP.	22pF	200V	CH	GRM40CH220J200PT	K22230220		1-	B	b2
C 1434	CHIP CAP.	0.5pF	200V	CK	GRM1884C2DR50CY21D	K22234201	USA A2	1-	B	b1
C 1434	CHIP CAP.	0.5pF	200V	CK	GRM1884C2DR50CY21D	K22234201	VER. A1	1-	B	b1
C 1434	CHIP CAP.	0.5pF	200V	CK	GRM1884C2DR50CY21D	K22234201	VER. A2	1-	B	b1
C 1434	CHIP CAP.	0.5pF	200V	CK	GRM1884C2DR50CY21D	K22234201	VER. A3	1-	B	b1
C 1434	CHIP CAP.	0.5pF	200V	CK	GRM1884C2DR50CY21D	K22234201	VER. B1	1-	B	b1
C 1434	CHIP CAP.	0.5pF	200V	CK	GRM1884C2DR50CY21D	K22234201	VER. B2	1-	B	b1
C 1434	CHIP CAP.	0.5pF	200V	CK	GRM1884C2DR50CY21D	K22234201	VER. B3	1-	B	b1
C 1434	CHIP CAP.	0.5pF	200V	CK	GRM1884C2DR50CY21D	K22234201	VER. C1	1-	B	b1
C 1434	CHIP CAP.	0.5pF	200V	CK	GRM1884C2DR50CY21D	K22234201	VER. C2	1-	B	b1
C 1434	CHIP CAP.	0.5pF	200V	CK	GRM1884C2DR50CY21D	K22234201	VER. C3	1-	B	b1
C 1434	CHIP CAP.	0.5pF	200V	CK	GRM1884C2DR50CY21D	K22234201	VER. D1	1-	B	b1
C 1434	CHIP CAP.	0.5pF	200V	CK	GRM1884C2DR50CY21D	K22234201	VER. D2	1-	B	b1
C 1434	CHIP CAP.	0.5pF	200V	CK	GRM1884C2DR50CY21D	K22234201	VER. H1	1-	B	b1
C 1434	CHIP CAP.	0.5pF	200V	CK	GRM1884C2DR50CY21D	K22234201	VER. H2	1-	B	b1
C 1435	CHIP CAP.	5pF	50V	CH	GRM36CH050B50PT	K22178292	VER. FH	1-	B	b1
C 1435	CHIP CAP.	5pF	50V	CH	GRM36CH050B50PT	K22178292	USA A2	1-	B	b1
C 1435	CHIP CAP.	5pF	50V	CH	GRM36CH050B50PT	K22178292	VER. A1	1-	B	b1
C 1435	CHIP CAP.	5pF	50V	CH	GRM36CH050B50PT	K22178292	VER. A2	1-	B	b1
C 1435	CHIP CAP.	5pF	50V	CH	GRM36CH050B50PT	K22178292	VER. A3	1-	B	b1
C 1435	CHIP CAP.	5pF	50V	CH	GRM36CH050B50PT	K22178292	VER. B1	1-	B	b1
C 1435	CHIP CAP.	5pF	50V	CH	GRM36CH050B50PT	K22178292	VER. B2	1-	B	b1
C 1435	CHIP CAP.	5pF	50V	CH	GRM36CH050B50PT	K22178292	VER. B3	1-	B	b1
C 1435	CHIP CAP.	5pF	50V	CH	GRM36CH050B50PT	K22178292	VER. C1	1-	B	b1

MAIN Unit

Parts List

REF	DESCRIPTION	VALUE	V/W	TOL.	MFR'S DESIG	VXSTD P/N	VERS.	LOT	SIDE	LAY ADR
C 1435	CHIP CAP.	5pF	50V	CH	GRM36CH050B50PT	K22178292	VER. C3	1-	B	b1
C 1435	CHIP CAP.	5pF	50V	CH	GRM36CH050B50PT	K22178292	VER. D1	1-	B	b1
C 1435	CHIP CAP.	5pF	50V	CH	GRM36CH050B50PT	K22178292	VER. D2	1-	B	b1
C 1435	CHIP CAP.	5pF	50V	CH	GRM36CH050B50PT	K22178292	VER. H1	1-	B	b1
C 1435	CHIP CAP.	5pF	50V	CH	GRM36CH050B50PT	K22178292	VER. H2	1-	B	b1
C 1436	CHIP CAP.	0.001uF	50V	B	GRM36B102K50PT	K22178809		1-	B	b1
C 1437	CHIP CAP.	0.0047uF	25V	B	GRM36B472K25PT	K22148830		1-	B	c2
C 1438	CHIP CAP.	0.001uF	50V	B	GRM36B102K50PT	K22178809		1-	B	b1
C 1439	CHIP CAP.	4pF	50V	CH	GRM36CH040B50PT	K22178291	USA A2	1-	B	b1
C 1439	CHIP CAP.	4pF	50V	CH	GRM36CH040B50PT	K22178291	VER. A1	1-	B	b1
C 1439	CHIP CAP.	4pF	50V	CH	GRM36CH040B50PT	K22178291	VER. A2	1-	B	b1
C 1439	CHIP CAP.	4pF	50V	CH	GRM36CH040B50PT	K22178291	VER. A3	1-	B	b1
C 1439	CHIP CAP.	4pF	50V	CH	GRM36CH040B50PT	K22178291	VER. B1	1-	B	b1
C 1439	CHIP CAP.	4pF	50V	CH	GRM36CH040B50PT	K22178291	VER. B2	1-	B	b1
C 1439	CHIP CAP.	4pF	50V	CH	GRM36CH040B50PT	K22178291	VER. B3	1-	B	b1
C 1439	CHIP CAP.	4pF	50V	CH	GRM36CH040B50PT	K22178291	VER. C1	1-	B	b1
C 1439	CHIP CAP.	4pF	50V	CH	GRM36CH040B50PT	K22178291	VER. C2	1-	B	b1
C 1439	CHIP CAP.	4pF	50V	CH	GRM36CH040B50PT	K22178291	VER. C3	1-	B	b1
C 1439	CHIP CAP.	4pF	50V	CH	GRM36CH040B50PT	K22178291	VER. D1	1-	B	b1
C 1439	CHIP CAP.	4pF	50V	CH	GRM36CH040B50PT	K22178291	VER. D2	1-	B	b1
C 1439	CHIP CAP.	4pF	50V	CH	GRM36CH040B50PT	K22178291	VER. H1	1-	B	b1
C 1439	CHIP CAP.	4pF	50V	CH	GRM36CH040B50PT	K22178291	VER. H2	1-	B	b1
C 1440	CHIP CAP.	22pF	200V	CH	GRM40CH220J200PT	K22230220		1-	B	b2
C 1441	CHIP CAP.	7pF	200V	CH	GRM1882C2D7R0DV01D	K22234209		1-	B	b2
C 1442	CHIP CAP.	22pF	200V	CH	GRM40CH220J200PT	K22230220		1-	B	b2
C 1443	CHIP CAP.	27pF	200V	CH	GRM40CH270J200PT	K22230221		1-	B	b2
C 1444	CHIP CAP.	0.5pF	200V	CK	GRM1884C2DR50CY21D	K22234201	USA A2	1-	B	b2
C 1444	CHIP CAP.	0.5pF	200V	CK	GRM1884C2DR50CY21D	K22234201	VER. A1	1-	B	b2
C 1444	CHIP CAP.	0.5pF	200V	CK	GRM1884C2DR50CY21D	K22234201	VER. A2	1-	B	b2
C 1444	CHIP CAP.	0.5pF	200V	CK	GRM1884C2DR50CY21D	K22234201	VER. A3	1-	B	b2
C 1444	CHIP CAP.	0.5pF	200V	CK	GRM1884C2DR50CY21D	K22234201	VER. B1	1-	B	b2
C 1444	CHIP CAP.	0.5pF	200V	CK	GRM1884C2DR50CY21D	K22234201	VER. B2	1-	B	b2
C 1444	CHIP CAP.	0.5pF	200V	CK	GRM1884C2DR50CY21D	K22234201	VER. B3	1-	B	b2
C 1444	CHIP CAP.	0.5pF	200V	CK	GRM1884C2DR50CY21D	K22234201	VER. C1	1-	B	b2
C 1444	CHIP CAP.	0.5pF	200V	CK	GRM1884C2DR50CY21D	K22234201	VER. C2	1-	B	b2
C 1444	CHIP CAP.	0.5pF	200V	CK	GRM1884C2DR50CY21D	K22234201	VER. C3	1-	B	b2
C 1444	CHIP CAP.	0.5pF	200V	CK	GRM1884C2DR50CY21D	K22234201	VER. D1	1-	B	b2
C 1444	CHIP CAP.	0.5pF	200V	CK	GRM1884C2DR50CY21D	K22234201	VER. D2	1-	B	b2
C 1444	CHIP CAP.	0.5pF	200V	CK	GRM1884C2DR50CY21D	K22234201	VER. H1	1-	B	b2
C 1444	CHIP CAP.	0.5pF	200V	CK	GRM1884C2DR50CY21D	K22234201	VER. H2	1-	B	b2
C 1445	CHIP CAP.	18pF	200V	CH	GRM40CH180J200PT	K22230219		1-	B	b2
C 1446	CHIP CAP.	220pF	200V	CH	GRM40CH221J200PT	K22230232		1-	B	a2
C 1447	CHIP CAP.	220pF	200V	CH	GRM40CH221J200PT	K22230232		1-	B	a2
C 1448	CHIP CAP.	15pF	200V	CH	GRM40CH150J200PT	K22230218		1-	B	a3
C 1449	CHIP CAP.	15pF	200V	CH	GRM40CH150J200PT	K22230218		1-	B	a3
C 1450	CHIP CAP.	22pF	50V	CH	GRM36CH220J50PT	K22178220	AUS	1-	B	b2
C 1450	CHIP CAP.	22pF	50V	CH	GRM36CH220J50PT	K22178220	EXP	1-	B	b2
C 1450	CHIP CAP.	22pF	50V	CH	GRM36CH220J50PT	K22178220	USA	1-	B	b2
C 1452	CHIP CAP.	0.001uF	50V	B	GRM36B102K50PT	K22178809		1-	B	b2
C 1453	CHIP CAP.	0.001uF	50V	B	GRM36B102K50PT	K22178809		1-	A	E4
C 1454	FILM CAP.	12pF	500V		UC232H0120J-T	K33279020		1-	A	F2
C 1456	CHIP CAP.	100pF	200V	CH	GRM40CH101J200PT	K22230228		1-	A	F2
C 1457	CHIP CAP.	100pF	200V	CH	GRM40CH101J200PT	K22230228		1-	A	F2
C 1458	CHIP CAP.	0.001uF	50V	B	GRM36B102K50PT	K22178809		1-	A	F3
C 1461	CHIP CAP.	0.5pF	200V	CK	GRM1884C2DR50CY21D	K22234201	USA A2	1-	B	c3
C 1461	CHIP CAP.	0.5pF	200V	CK	GRM1884C2DR50CY21D	K22234201	VER. A1	1-	B	c3
C 1461	CHIP CAP.	0.5pF	200V	CK	GRM1884C2DR50CY21D	K22234201	VER. A2	1-	B	c3
C 1461	CHIP CAP.	0.5pF	200V	CK	GRM1884C2DR50CY21D	K22234201	VER. A3	1-	B	c3
C 1461	CHIP CAP.	0.5pF	200V	CK	GRM1884C2DR50CY21D	K22234201	VER. B1	1-	B	c3
C 1461	CHIP CAP.	0.5pF	200V	CK	GRM1884C2DR50CY21D	K22234201	VER. B2	1-	B	c3
C 1461	CHIP CAP.	0.5pF	200V	CK	GRM1884C2DR50CY21D	K22234201	VER. B3	1-	B	c3
C 1461	CHIP CAP.	0.5pF	200V	CK	GRM1884C2DR50CY21D	K22234201	VER. C1	1-	B	c3
C 1461	CHIP CAP.	0.5pF	200V	CK	GRM1884C2DR50CY21D	K22234201	VER. C2	1-	B	c3
C 1461	CHIP CAP.	0.5pF	200V	CK	GRM1884C2DR50CY21D	K22234201	VER. C3	1-	B	c3
C 1461	CHIP CAP.	0.5pF	200V	CK	GRM1884C2DR50CY21D	K22234201	VER. D1	1-	B	c3
C 1461	CHIP CAP.	0.5pF	200V	CK	GRM1884C2DR50CY21D	K22234201	VER. D2	1-	B	c3
C 1461	CHIP CAP.	0.5pF	200V	CK	GRM1884C2DR50CY21D	K22234201	VER. H1	1-	B	c3
C 1461	CHIP CAP.	0.5pF	200V	CK	GRM1884C2DR50CY21D	K22234201	VER. H2	1-	B	c3
C 1462	CHIP CAP.	6pF	50V	CH	GRM36CH060B50PT	K22178293	VER. FH	1-	B	c3
C 1462	CHIP CAP.	6pF	50V	CH	GRM36CH060B50PT	K22178293	USA A2	1-	B	c3
C 1462	CHIP CAP.	6pF	50V	CH	GRM36CH060B50PT	K22178293	VER. A1	1-	B	c3
C 1462	CHIP CAP.	6pF	50V	CH	GRM36CH060B50PT	K22178293	VER. A2	1-	B	c3
C 1462	CHIP CAP.	6pF	50V	CH	GRM36CH060B50PT	K22178293	VER. A3	1-	B	c3

MAIN Unit

Parts List

REF	DESCRIPTION	VALUE	V/W	TOL.	MFR'S DESIG	VXSTD P/N	VERS.	LOT	SIDE	LAY ADR
C 1462	CHIP CAP.	6pF	50V	CH	GRM36CH060B50PT	K22178293	VER. B1	1-	B	c3
C 1462	CHIP CAP.	6pF	50V	CH	GRM36CH060B50PT	K22178293	VER. B2	1-	B	c3
C 1462	CHIP CAP.	6pF	50V	CH	GRM36CH060B50PT	K22178293	VER. B3	1-	B	c3
C 1462	CHIP CAP.	6pF	50V	CH	GRM36CH060B50PT	K22178293	VER. C1	1-	B	c3
C 1462	CHIP CAP.	6pF	50V	CH	GRM36CH060B50PT	K22178293	VER. C2	1-	B	c3
C 1462	CHIP CAP.	6pF	50V	CH	GRM36CH060B50PT	K22178293	VER. C3	1-	B	c3
C 1462	CHIP CAP.	6pF	50V	CH	GRM36CH060B50PT	K22178293	VER. D1	1-	B	c3
C 1462	CHIP CAP.	6pF	50V	CH	GRM36CH060B50PT	K22178293	VER. D2	1-	B	c3
C 1462	CHIP CAP.	6pF	50V	CH	GRM36CH060B50PT	K22178293	VER. H1	1-	B	c3
C 1462	CHIP CAP.	6pF	50V	CH	GRM36CH060B50PT	K22178293	VER. H2	1-	B	c3
C 1463	CHIP CAP.	0.001uF	50V	B	GRM36B102K50PT	K22178809		1-	B	c3
C 1464	CHIP CAP.	0.5pF	200V	CK	GRM1884C2DR50CY21D	K22234201		1-	A	F3
C 1465	CHIP CAP.	2pF	200V	CK	GRM1884C2D2R0CV01D	K22234204		1-	A	F3
C 1466	CHIP CAP.	2pF	200V	CK	GRM1884C2D2R0CV01D	K22234204		1-	B	c3
C 1467	CHIP CAP.	2pF	200V	CK	GRM1884C2D2R0CV01D	K22234204		1-	A	G3
C 1468	CHIP CAP.	3pF	200V	CJ	GRM1883C2D3R0CV01D	K22234205		1-	A	G3
C 1469	CHIP CAP.	0.001uF	50V	B	GRM36B102K50PT	K22178809		1-	A	G3
C 1470	CHIP CAP.	4pF	50V	CH	GRM36CH040B50PT	K22178291	USA A2	1-	A	G3
C 1470	CHIP CAP.	4pF	50V	CH	GRM36CH040B50PT	K22178291	VER. A1	1-	A	G3
C 1470	CHIP CAP.	4pF	50V	CH	GRM36CH040B50PT	K22178291	VER. A2	1-	A	G3
C 1470	CHIP CAP.	4pF	50V	CH	GRM36CH040B50PT	K22178291	VER. A3	1-	A	G3
C 1470	CHIP CAP.	4pF	50V	CH	GRM36CH040B50PT	K22178291	VER. B1	1-	A	G3
C 1470	CHIP CAP.	4pF	50V	CH	GRM36CH040B50PT	K22178291	VER. B2	1-	A	G3
C 1470	CHIP CAP.	4pF	50V	CH	GRM36CH040B50PT	K22178291	VER. B3	1-	A	G3
C 1470	CHIP CAP.	4pF	50V	CH	GRM36CH040B50PT	K22178291	VER. C1	1-	A	G3
C 1470	CHIP CAP.	4pF	50V	CH	GRM36CH040B50PT	K22178291	VER. C2	1-	A	G3
C 1470	CHIP CAP.	4pF	50V	CH	GRM36CH040B50PT	K22178291	VER. C3	1-	A	G3
C 1470	CHIP CAP.	4pF	50V	CH	GRM36CH040B50PT	K22178291	VER. D1	1-	A	G3
C 1470	CHIP CAP.	4pF	50V	CH	GRM36CH040B50PT	K22178291	VER. D2	1-	A	G3
C 1470	CHIP CAP.	4pF	50V	CH	GRM36CH040B50PT	K22178291	VER. H1	1-	A	G3
C 1470	CHIP CAP.	4pF	50V	CH	GRM36CH040B50PT	K22178291	VER. H2	1-	A	G3
C 1471	CHIP CAP.	0.5pF	200V	CK	GRM1884C2DR50CY21D	K22234201	USA A2	1-	A	G3
C 1471	CHIP CAP.	0.5pF	200V	CK	GRM1884C2DR50CY21D	K22234201	VER. A1	1-	A	G3
C 1471	CHIP CAP.	0.5pF	200V	CK	GRM1884C2DR50CY21D	K22234201	VER. A2	1-	A	G3
C 1471	CHIP CAP.	0.5pF	200V	CK	GRM1884C2DR50CY21D	K22234201	VER. A3	1-	A	G3
C 1471	CHIP CAP.	0.5pF	200V	CK	GRM1884C2DR50CY21D	K22234201	VER. B1	1-	A	G3
C 1471	CHIP CAP.	0.5pF	200V	CK	GRM1884C2DR50CY21D	K22234201	VER. B2	1-	A	G3
C 1471	CHIP CAP.	0.5pF	200V	CK	GRM1884C2DR50CY21D	K22234201	VER. B3	1-	A	G3
C 1471	CHIP CAP.	0.5pF	200V	CK	GRM1884C2DR50CY21D	K22234201	VER. C1	1-	A	G3
C 1471	CHIP CAP.	0.5pF	200V	CK	GRM1884C2DR50CY21D	K22234201	VER. C2	1-	A	G3
C 1471	CHIP CAP.	0.5pF	200V	CK	GRM1884C2DR50CY21D	K22234201	VER. C3	1-	A	G3
C 1471	CHIP CAP.	0.5pF	200V	CK	GRM1884C2DR50CY21D	K22234201	VER. D1	1-	A	G3
C 1471	CHIP CAP.	0.5pF	200V	CK	GRM1884C2DR50CY21D	K22234201	VER. D2	1-	A	G3
C 1471	CHIP CAP.	0.5pF	200V	CK	GRM1884C2DR50CY21D	K22234201	VER. H1	1-	A	G3
C 1471	CHIP CAP.	0.5pF	200V	CK	GRM1884C2DR50CY21D	K22234201	VER. H2	1-	A	G3
C 1472	CHIP CAP.	1.5pF	200V	CK	GRM1884C2D1R5CV01D	K22234213		1-	A	G3
C 1473	CHIP CAP.	3pF	200V	CJ	GRM1883C2D3R0CV01D	K22234205		1-	A	G3
C 1474	CHIP CAP.	4pF	200V	CH	GRM1882C2D4R0CV01D	K22234206		1-	A	G3
C 1475	CHIP CAP.	4pF	200V	CH	GRM1882C2D4R0CV01D	K22234206		1-	A	G3
C 1476	CHIP CAP.	0.5pF	200V	CK	GRM1884C2DR50CY21D	K22234201		1-	A	H3
C 1477	CHIP CAP.	2pF	200V	CK	GRM1884C2D2R0CV01D	K22234204		1-	A	H3
C 1478	CHIP CAP.	2pF	200V	CK	GRM1884C2D2R0CV01D	K22234204		1-	A	H3
C 1479	CHIP CAP.	3pF	50V	CJ	GRM36CJ030B50PT	K22178290		1-	A	H4
C 1480	CHIP CAP.	4pF	200V	CH	GRM1882C2D4R0CV01D	K22234206		1-	A	H3
C 1481	CHIP CAP.	4pF	200V	CH	GRM1882C2D4R0CV01D	K22234206		1-	A	H3
C 1482	CHIP CAP.	0.001uF	50V	B	GRM36B102K50PT	K22178809		1-	B	h7
C 1483	CHIP TA.CAP.	10uF	10V		TEMSVA1A106M-8R	K78100028		1-	B	h7
C 1484	CHIP CAP.	100pF	50V	CH	GRM39CH101J50PT	K22174235		1-	A	D2
C 1486	CHIP CAP.	0.001uF	50V	B	GRM36B102K50PT	K22178809		1-	A	G4
C 1487	CHIP CAP.	1pF	50V	CK	GRM36CK010B50PT	K22178287		1-	B	d5
C 1491	CHIP CAP.	12pF	50V	CH	GRM36CH120J50PT	K22178214		1-	A	D3
C 1492	CHIP CAP.	0.001uF	50V	B	GRM36B102K50PT	K22178809		1-	B	c3
C 1493	CHIP CAP.	0.001uF	50V	B	GRM36B102K50PT	K22178809		1-	A	E5
C 1495	AL.ELECTRO.CAP.	100uF	16V		16V101M6X7TR2	K46120007		1-	A	A4
C 1497	CHIP CAP.	1pF	50V	CK	GRM36CK010B50PT	K22178287		1-	A	F5
C 1499	CHIP CAP.	82pF	50V	CH	GRM36CH820J50PT	K22178234	AUS	1-	B	h5
C 1499	CHIP CAP.	82pF	50V	CH	GRM36CH820J50PT	K22178234	EXP	1-	B	h5
C 1500	CHIP CAP.	0.001uF	50V	B	GRM36B102K50PT	K22178809	AUS	1-	B	h5
C 1500	CHIP CAP.	0.001uF	50V	B	GRM36B102K50PT	K22178809	EXP	1-	B	h5
CD1001	CERAMIC DISC				CDBM450C24	H7901390		1-	A	D7
CF1001	CERAMIC FILTER				CFWM450E	H3900466		1-	A	D6
D 1001	DIODE				HSC277TRF	G2070584		1-	B	c4
D 1002	DIODE				HVC350B-TRF	G2070596		1-	B	c5

MAIN Unit

Parts List

REF	DESCRIPTION	VALUE	V/W	TOL.	MFR'S DESIG	VXSTD P/N	VERS.	LOT	SIDE	LAY ADR
D 1003	DIODE				HVC350B-TRF	G2070596		1-	B	d5
D 1004	DIODE				HVC350B-TRF	G2070596		1-	B	d4
D 1005	DIODE				HVC131TRF	G2070676		1-	B	c4
D 1006	DIODE				HVC131TRF	G2070676		1-	A	E5
D 1007	DIODE				HVC131TRF	G2070676		1-	A	E5
D 1009	DIODE				HVC131TRF	G2070676		1-	B	b3
D 1010	DIODE				HVC365 TRF	G2070902		1-	B	c5
D 1011	DIODE				HVC365 TRF	G2070902		1-	B	c5
D 1012	DIODE				HVC365 TRF	G2070902		1-	B	d5
D 1013	DIODE				HVC131TRF	G2070676		1-	A	E5
D 1015	DIODE				HVC131TRF	G2070676		1-	B	b2
D 1016	DIODE				HVC131TRF	G2070676		1-	B	b2
D 1017	DIODE				HVC131TRF	G2070676		1-	A	E5
D 1018	DIODE				RLS135 TE-11	G2070128		1-	B	c3
D 1019	DIODE				RLS135 TE-11	G2070128		1-	B	c3
D 1020	DIODE				HVC131TRF	G2070676		1-	A	E4
D 1021	DIODE				HVC131TRF	G2070676		1-	A	D4
D 1022	DIODE				DAN222 TL	G2070174		1-	A	E7
D 1023	DIODE				MA2S72800L	G2070858		1-	B	f7
D 1028	DIODE				DAN222 TL	G2070174		1-	B	g5
D 1030	DIODE				DA221 TL	G2070178		1-	B	h6
D 1031	DIODE				HZM27WA-TR	G2070530		1-	B	g7
D 1032	DIODE				HZM27WA-TR	G2070530		1-	B	f7
D 1033	SURGE ABSORBER				P6KA18	Q9000721		1-	A	C1
D 1035	DIODE				MA2S111-(TX)	G2070614		1-	B	h4
D 1036	DIODE				D1F20-4063	G2070474		1-	B	i4
D 1037	DIODE				DAN222 TL	G2070174		1-	B	i5
D 1038	DIODE				DAN222 TL	G2070174		1-	B	i5
D 1039	DIODE				DAN222 TL	G2070174		1-	B	h7
D 1040	DIODE				DA221 TL	G2070178		1-	A	D5
D 1041	DIODE				HVC365 TRF	G2070902		1-	B	f6
D 1042	DIODE				HVC365 TRF	G2070902		1-	B	f6
D 1043	DIODE				HVC350B-TRF	G2070596		1-	B	e6
D 1044	DIODE				HVC365 TRF	G2070902		1-	B	e6
D 1045	DIODE				DA221 TL	G2070178		1-	B	e6
D 1046	DIODE				HVC375B-TRF	G2070856		1-	B	e5
D 1047	DIODE				HVC350B-TRF	G2070596		1-	B	e5
D 1048	DIODE				HSC277TRF	G2070584		1-	B	e5
D 1049	DIODE				HVC365 TRF	G2070902		1-	B	e5
D 1050	DIODE				HVC131TRF	G2070676		1-	B	e5
D 1051	DIODE				HVC365 TRF	G2070902		1-	B	e5
D 1052	DIODE				HVC362TRF	G2070636		1-	B	e5
D 1053	DIODE				HSC277TRF	G2070584		1-	A	D5
D 1054	DIODE				HSC277TRF	G2070584		1-	A	D5
D 1055	DIODE				HSC277TRF	G2070584		1-	A	E4
D 1056	DIODE				DAN222 TL	G2070174		1-	B	f5
D 1057	DIODE				HSC277TRF	G2070584		1-	A	D4
D 1058	DIODE				DAN222 TL	G2070174		1-	B	e4
D 1059	DIODE				DAN222 TL	G2070174		1-	B	f4
D 1060	DIODE				HSC277TRF	G2070584		1-	B	e4
D 1061	DIODE				HSC277TRF	G2070584		1-	B	e4
D 1062	DIODE				HZM13NB2 TR	G2070894		1-	B	e3
D 1063	DIODE				DAN222 TL	G2070174		1-	A	E3
D 1064	DIODE				HSC277TRF	G2070584		1-	A	D3
D 1065	DIODE				HSC277TRF	G2070584		1-	A	D3
D 1066	DIODE				RLS135 TE-11	G2070128		1-	A	C3
D 1067	DIODE				RLS135 TE-11	G2070128		1-	A	D2
D 1068	DIODE				HSC277TRF	G2070584	USA A2	1-	A	C2
D 1068	DIODE				HSC277TRF	G2070584	VER. A1	1-	A	C2
D 1068	DIODE				HSC277TRF	G2070584	VER. A2	1-	A	C2
D 1068	DIODE				HSC277TRF	G2070584	VER. A3	1-	A	C2
D 1068	DIODE				HSC277TRF	G2070584	VER. B1	1-	A	C2
D 1068	DIODE				HSC277TRF	G2070584	VER. B2	1-	A	C2
D 1068	DIODE				HSC277TRF	G2070584	VER. B3	1-	A	C2
D 1068	DIODE				HSC277TRF	G2070584	VER. C1	1-	A	C2
D 1068	DIODE				HSC277TRF	G2070584	VER. C2	1-	A	C2
D 1068	DIODE				HSC277TRF	G2070584	VER. C3	1-	A	C2
D 1068	DIODE				HSC277TRF	G2070584	VER. D1	1-	A	C2
D 1068	DIODE				HSC277TRF	G2070584	VER. D2	1-	A	C2
D 1068	DIODE				HSC277TRF	G2070584	VER. H1	1-	A	C2
D 1068	DIODE				HSC277TRF	G2070584	VER. H2	1-	A	C2
D 1069	DIODE				HSC277TRF	G2070584	USA A2	1-	A	C2
D 1069	DIODE				HSC277TRF	G2070584	VER. A1	1-	A	C2

MAIN Unit

Parts List

REF	DESCRIPTION	VALUE	V/W	TOL.	MFR'S DESIG	VXSTD P/N	VERS.	LOT	SIDE	LAY ADR
D 1069	DIODE				HSC277TRF	G2070584	VER. A2	1-	A	C2
D 1069	DIODE				HSC277TRF	G2070584	VER. A3	1-	A	C2
D 1069	DIODE				HSC277TRF	G2070584	VER. B1	1-	A	C2
D 1069	DIODE				HSC277TRF	G2070584	VER. B2	1-	A	C2
D 1069	DIODE				HSC277TRF	G2070584	VER. B3	1-	A	C2
D 1069	DIODE				HSC277TRF	G2070584	VER. C1	1-	A	C2
D 1069	DIODE				HSC277TRF	G2070584	VER. C2	1-	A	C2
D 1069	DIODE				HSC277TRF	G2070584	VER. C3	1-	A	C2
D 1069	DIODE				HSC277TRF	G2070584	VER. D1	1-	A	C2
D 1069	DIODE				HSC277TRF	G2070584	VER. D2	1-	A	C2
D 1069	DIODE				HSC277TRF	G2070584	VER. H1	1-	A	C2
D 1069	DIODE				HSC277TRF	G2070584	VER. H2	1-	A	C2
D 1070	DIODE				MA2S72800L	G2070858		1-	B	b1
D 1071	DIODE				MA2S72800L	G2070858		1-	B	b1
D 1072	DIODE				XB15A709A0HR	G2070826		1-	A	H1
D 1073	DIODE				XB15A709A0HR	G2070826		1-	A	H2
D 1074	DIODE				RLS135 TE-11	G2070128		1-	A	H2
D 1075	DIODE				RLS135 TE-11	G2070128		1-	A	H2
D 1076	DIODE				UM9401F/TR	G2070516		1-	A	F2
D 1077	DIODE				UM9401F/TR	G2070516		1-	A	F3
D 1078	DIODE				MA2S72800L	G2070858		1-	B	c3
D 1079	DIODE				MA2S72800L	G2070858		1-	A	G3
D 1080	SURGE ABSORBER				RCCA-301Q43UA	Q9000756		1-	A	H3
D 1081	DIODE				UDZS TE-17 6.8B	G2070888		1-	A	D3
D 1084	DIODE				HSC277TRF	G2070584		1-	B	c3
FB1001	BEADS COIL				B-01-A	L1190386		1-	A	B1
FB1002	FERRITE BEADS				SMB304729	L9190094		1-	A	C1
FB1003	FERRITE BEADS				SMB304729	L9190094		1-	A	C4
HS1001	HEATSINK PLATE					RA0227600		1-	B	f3
J 1001	CONNECTOR				HSJ6062-01-450	P1091168		1-	A	A1
J 1002	CONNECTOR				SC25-02WS	P0090621		1-	A	A4
J 1003	CONNECTOR				MD-S6000-90	P1091087		1-	B	g1
J 1004	CONNECTOR				B2B-ZR	P0090647		1-	A	C1
J 1005	CONNECTOR				MJ-66J-RD315K	P1091049		1-	A	C7
L 1001	M.RFC	0.01uH		2%	C1608CA-10NG	L1691032		1-	B	c3
L 1002	M.RFC	0.012uH		2%	C1608CA-12NG	L1691033		1-	B	c4
L 1003	M.RFC	0.039uH		2%	C1608CA-39NG	L1691039		1-	B	c4
L 1004	M.RFC	0.1uH			TFL0816-100N	L1690981		1-	B	c5
L 1005	M.RFC	0.01uH		2%	C1608CA-10NG	L1691032		1-	B	c4
L 1006	COIL				E2 0.28-1.0-4T-R	L0022365		1-	B	d5
L 1007	COIL				E2 0.28-1.0-4T-R	L0022365		1-	B	d4
L 1008	M.RFC	0.015uH			TFL0816-15	L1690493		1-	A	F5
L 1009	M.RFC	0.015uH			TFL0816-15	L1690493		1-	A	F5
L 1010	M.RFC	0.015uH			TFL0816-15	L1690493		1-	B	d5
L 1011	M.RFC	0.082uH		2%	C1608CA-82NG	L1691044		1-	B	b3
L 1012	M.RFC	0.056uH		2%	C1608CA-56NG	L1691041	AUS	1-	B	b3
L 1012	M.RFC	0.056uH		2%	C1608CA-56NG	L1691041	EXP	1-	B	b3
L 1012	M.RFC	0.056uH		2%	C1608CA-56NG	L1691041	USA	1-	B	b3
L 1013	M.RFC	0.047uH		2%	C1608CA-47NG	L1691040	AUS	1-	B	b3
L 1013	M.RFC	0.047uH		2%	C1608CA-47NG	L1691040	EXP	1-	B	b3
L 1013	M.RFC	0.047uH		2%	C1608CA-47NG	L1691040	USA	1-	B	b3
L 1014	M.RFC	0.039uH		2%	C1608CA-39NG	L1691039	AUS	1-	B	b4
L 1014	M.RFC	0.039uH		2%	C1608CA-39NG	L1691039	EXP	1-	B	b4
L 1014	M.RFC	0.039uH		2%	C1608CA-39NG	L1691039	USA	1-	B	b4
L 1015	M.RFC	0.15uH		2%	C1608CA-R15G	L1691101	AUS	1-	B	b4
L 1015	M.RFC	0.15uH		2%	C1608CA-R15G	L1691101	EXP	1-	B	b4
L 1015	M.RFC	0.15uH		2%	C1608CA-R15G	L1691101	USA	1-	B	b4
L 1016	M.RFC	1uH			LK1608 1R0K-T	L1690687		1-	B	c5
L 1017	M.RFC	0.082uH		2%	C1608CA-82NG	L1691044		1-	B	c5
L 1018	M.RFC	0.082uH		2%	C1608CA-82NG	L1691044		1-	B	c5
L 1019	M.RFC	0.082uH		2%	C1608CA-82NG	L1691044		1-	B	d5
L 1020	M.RFC	0.047uH			TFL0816-47	L1690499		1-	B	d5
L 1021	M.RFC	0.068uH		2%	C1608CA-68NG	L1691042		1-	B	b3
L 1022	M.RFC	0.022uH		2%	C1608CA-22NG	L1691036		1-	B	b3
L 1023	M.RFC	0.022uH		2%	C1608CA-22NG	L1691036		1-	B	b4
L 1024	M.RFC	0.082uH		2%	C1608CA-82NG	L1691044		1-	B	b4
L 1025	M.RFC	0.039uH			TFL0816-39	L1690498		1-	B	c5
L 1026	M.RFC	0.039uH			TFL0816-39	L1690498		1-	B	d5
L 1027	M.RFC	0.01uH			TFL0816-10	L1690491		1-	B	a4
L 1028	M.RFC	0.01uH			TFL0816-10	L1690491		1-	B	a4
L 1029	M.RFC	0.0047uH			TFL0816-4N7	L1690487		1-	B	a4
L 1030	M.RFC	0.0047uH			TFL0816-4N7	L1690487		1-	A	H4
L 1031	M.RFC	0.0047uH			TFL0816-4N7	L1690487		1-	A	H5

MAIN Unit

Parts List

REF	DESCRIPTION	VALUE	V/W	TOL.	MFR'S DESIG	VXSTD P/N	VERS.	LOT	SIDE	LAY ADR
L 1032	M.RFC	0.0047uH			TFL0816-4N7	L1690487		1-	A	G5
L 1033	M.RFC	0.0047uH			TFL0816-4N7	L1690487		1-	A	F4
L 1034	M.RFC	0.0047uH			TFL0816-4N7	L1690487		1-	A	F5
L 1035	M.RFC	0.0047uH			TFL0816-4N7	L1690487		1-	A	E4
L 1036	M.RFC	0.022uH			TFL0816-22	L1690495		1-	A	F6
L 1037	M.RFC	0.39uH		2%	C1608CA-R39G	L1691107		1-	A	F6
L 1038	M.RFC	0.39uH		2%	C1608CA-R39G	L1691107		1-	A	E7
L 1039	M.RFC	1uH			LK1608 1R0K-T	L1690687		1-	B	d7
L 1040	M.RFC	0.39uH		2%	C1608CA-R39G	L1691107		1-	B	d6
L 1041	M.RFC	150uH			FLC32T-151J	L1690229		1-	B	h6
L 1042	M.RFC	1uH			LK1608 1R0K-T	L1690687		1-	B	h7
L 1043	M.RFC	1uH			LK1608 1R0K-T	L1690687		1-	A	D6
L 1044	M.RFC	1uH			ELJ-ND1R0JF	L1690977		1-	B	e6
L 1045	M.RFC	1uH			LK1608 1R0K-T	L1690687		1-	B	e5
L 1046	COIL				E2 0.3-1.1-3T-R	L0022579		1-	B	e5
L 1047	M.RFC	0.0039uH			TFL0816-3N9	L1690486		1-	B	e5
L 1048	M.RFC	0.022uH			TFL0816-22	L1690495		1-	B	e5
L 1049	M.RFC	1uH			LK1608 1R0K-T	L1690687		1-	B	e5
L 1050	CHIP COIL	0.056uH			LQN21A56NG04	L1690978		1-	B	e5
L 1051	M.RFC	0.0022uH			TFL0510-2N2	L1690803		1-	B	e5
L 1052	M.RFC	0.15uH			LK1608 R15K-T	L1690409		1-	B	e5
L 1053	M.RFC	1uH			LK1608 1R0K-T	L1690687		1-	B	g3
L 1054	M.RFC	0.47uH			LK2125 R47K-T	L1690315		1-	B	a5
L 1055	M.RFC	0.047uH			TFL0816-47	L1690499		1-	B	e4
L 1056	M.RFC	0.015uH			TFL0816-15	L1690493		1-	B	e4
L 1057	M.RFC	0.1uH		2%	C1608CA-R10G	L1691045		1-	A	C3
L 1058	M.RFC	0.0082uH			TFL0816-8N2	L1690490		1-	A	D4
L 1059	COIL				E2 0.35-1.6-4.5T-L	L0022577		1-	A	D4
L 1060	COIL				E2 0.3-1.1-3T-R	L0022579		1-	A	D4
L 1061	COIL	0.0033uH			AS050221-3R3NJ	L0022825		1-	A	D3
L 1062	COIL				E2 0.28-1.0-7TR	L0022422		1-	A	D3
L 1063	COIL	0.056uH			AS050635-56N	L0022813		1-	A	C3
L 1064	COIL	0.0033uH			AS050221-3R3NJ	L0022825		1-	A	C3
L 1065	COIL	0.009uH			AS050325-9RONJ	L0022826		1-	A	D2
L 1066	M.RFC	1uH			ELJ-ND1R0JF	L1690977		1-	B	f2
L 1067	COIL				E2 0.35-1.6-5.5T-L	L0022616		1-	A	C3
L 1068	COIL				E2 0.35-1.6-7T-L	L0022390		1-	A	C3
L 1069	M.RFC	1uH			ELJ-ND1R0JF	L1690977		1-	B	f3
L 1070	COIL	0.012uH			AS080336-12N	L0022810		1-	A	C2
L 1071	COIL A1				12.5T3.5D0.8UEW R	L0022828		1-	A	E1
L 1072	M.RFC	0.47uH			LK2125 R47K-T	L1690315		1-	A	E3
L 1073	COIL A1				1.5T3.0D1.2UEW R	L0022806		1-	A	F2
L 1074	COIL A1				3.5T3.5D1.0UEW R	L0022805		1-	A	F1
L 1075	COIL A1				4.5T3.5D1.0UEW R	L0022836		1-	A	G1
L 1076	COIL A1				3.5T3.5D1.0UEW R	L0022805		1-	A	G2
L 1077	COIL				E2 0.4-3.0-11.5T-L	L0022646		1-	A	G2
L 1078	COIL	0.038uH			AS050630-38N	L0022818		1-	A	H2
L 1079	COIL A1				3.5T3.5D1.0UEW R	L0022805		1-	A	H2
L 1080	COIL A1				3.5T3.5D1.0UEW R	L0022805		1-	A	H3
L 1081	M.RFC	0.039uH		2%	C1608CA-39NG	L1691039	AUS	1-	B	b2
L 1081	M.RFC	0.039uH		2%	C1608CA-39NG	L1691039	EXPORT	1-	B	b2
L 1081	M.RFC	0.039uH		2%	C1608CA-39NG	L1691039	USA	1-	B	b2
L 1082	COIL	0.0093uH			AS120252-9R3N	L0022853		1-	A	F2
L 1083	COIL				E2 0.25-1.9-5.5T-R	L0022610		1-	A	F2
L 1084	COIL A1				2.5T3.0D1.2UEW R	L0022807		1-	A	F3
L 1085	COIL	0.014uH			AS050425-14NK	L0022583		1-	A	G3
L 1086	COIL A1				2.5T3.0D1.2UEW R	L0022807		1-	A	G3
L 1087	COIL	0.015uH			AS100440-15N	L0022811		1-	A	H3
L 1088	COIL	0.01uH			AS1003-10NK	L0022544		1-	A	H4
L 1089	M.RFC	0.033uH			TFL0816-33	L1690497		1-	B	c4
L 1090	M.RFC	1uH			LK1608 1R0K-T	L1690687		1-	A	F6
L 1091	M.RFC	1uH			LK1608 1R0K-T	L1690687		1-	A	F6
L 1092	M.RFC	1uH			LK1608 1R0K-T	L1690687		1-	A	F6
L 1093	M.RFC	1uH			LK1608 1R0K-T	L1690687		1-	A	D5
L 1094	M.RFC	1uH			LK1608 1R0K-T	L1690687		1-	A	D5
L 1095	M.RFC	0.1uH			TFL0816-100N	L1690981		1-	A	D5
Q 1001	FET				3SK296ZQ-TL	G4802968		1-	B	c4
Q 1002	FET				3SK296ZQ-TL	G4802968		1-	B	d5
Q 1003	TRANSISTOR				2SC5006-T1	G3350068		1-	A	E5
Q 1008	FET				3SK296ZQ-TL	G4802968		1-	B	c4
Q 1009	FET				3SK296ZQ-TL	G4802968		1-	B	d5
Q 1010	FET				3SK296ZQ-TL	G4802968		1-	B	b4
Q 1011	TRANSISTOR				2SC5374-TL	G3353748		1-	B	d5

MAIN Unit

Parts List

REF	DESCRIPTION	VALUE	V/W	TOL.	MFR'S DESIG	VXSTD P/N	VERS.	LOT	SIDE	LAY ADR
Q 1012	TRANSISTOR				2SC5277-D2-TL	G3352778B		1-	A	H4
Q 1013	TRANSISTOR				2SC5006-T1	G3350068		1-	A	G4
Q 1014	TRANSISTOR				2SC5006-T1	G3350068		1-	A	E4
Q 1016	TRANSISTOR				2SC4400-3-TL	G3344008C		1-	A	E7
Q 1017	TRANSISTOR				2SC4617 TL R	G3346178R		1-	B	e7
Q 1018	TRANSISTOR				2SC4617 TL R	G3346178R		1-	B	f6
Q 1019	TRANSISTOR				2SC4617 TL R	G3346178R		1-	A	D7
Q 1020	TRANSISTOR				2SC4617 TL R	G3346178R		1-	A	D7
Q 1021	TRANSISTOR				2SC4617 TL R	G3346178R		1-	B	e6
Q 1022	TRANSISTOR				2SC4400-3-TL	G3344008C		1-	B	d6
Q 1023	IC				TA31136FN(EL)	G1091605		1-	A	E7
Q 1028	IC				NJM2902V-TE1	G1091679		1-	B	h5
Q 1029	TRANSISTOR				2SC4617 TL R	G3346178R		1-	A	B3
Q 1030	TRANSISTOR				2SC4617 TL R	G3346178R		1-	A	B3
Q 1031	IC				NJM2902V-TE1	G1091679		1-	B	h6
Q 1032	TRANSISTOR				DTC144EE TL	G3070075		1-	B	i5
Q 1033	TRANSISTOR				DTC144EE TL	G3070075		1-	B	i6
Q 1034	IC				M51132FP 600C	G1091930		1-	A	B3
Q 1035	IC				LA4425A	G1092241		1-	A	A2
Q 1036	TRANSISTOR				DTC144EE TL	G3070075		1-	B	h3
Q 1037	TRANSISTOR				DTC144EE TL	G3070075		1-	A	B1
Q 1038	TRANSISTOR				DTC144EE TL	G3070075		1-	A	B1
Q 1039	IC				BU4066BCFV-E2	G1093537		1-	A	B5
Q 1040	IC				NJM2902V-TE1	G1091679		1-	A	B5
Q 1041	TRANSISTOR				2SC4617 TL R	G3346178R		1-	B	f1
Q 1042	TRANSISTOR				DTC144EE TL	G3070075		1-	B	g6
Q 1043	TRANSISTOR				2SB1301-T2 ZQ	G3213017Q		1-	A	B2
Q 1044	TRANSISTOR				2SB1201S-TL	G3070195		1-	B	g2
Q 1045	IC				MM1216ENRE	G1092432		1-	B	g3
Q 1046	IC				NJM78L05UA TE1	G1091325		1-	A	B2
Q 1047	TRANSISTOR				2SC4617 TL R	G3346178R		1-	A	B2
Q 1049	IC				NJM78L05UA TE1	G1091325		1-	B	i4
Q 1050	IC				S-80823CNMC-B8I-T2	G1093635		1-	B	h5
Q 1051	TRANSISTOR				2SC4617 TL R	G3346178R		1-	B	i5
Q 1052	TRANSISTOR				2SC4617 TL R	G3346178R		1-	B	h6
Q 1053	IC				AT24C256N-10SI-1.8	G1093837		1-	B	i6
Q 1054	TRANSISTOR				DTC144EE TL	G3070075		1-	A	A5
Q 1055	TRANSISTOR				UMA8N TR	G3070270		1-	A	G6
Q 1056	TRANSISTOR				DTA144EE TL	G3070074		1-	A	G6
Q 1057	TRANSISTOR				UMA8N TR	G3070270		1-	A	G6
Q 1058	TRANSISTOR				IMT17 T110	G3070295		1-	A	H6
Q 1059	IC				BU2090FS-E1	G1092187		1-	A	G6
Q 1062	TRANSISTOR				DTA144EE TL	G3070074		1-	A	F6
Q 1063	TRANSISTOR				UMA8N TR	G3070270		1-	A	F6
Q 1064	TRANSISTOR				2SC4617 TL R	G3346178R		1-	A	F6
Q 1065	IC				M3826AEFGP	*		1-	A	B6
1066	AN I				D C144EE L	G3070075		1-	B	6
1067	AN I				D C144EE L	G3070075		1-	B	6
1068	AN I				D C144EE L	G3070075		1-	A	E5
1069	AN I				2 A1774 L	G3117748		1-	A	C6
1070	IC				MB15A02 F 1-G-BND-EF	G1092541		1-	A	D6
1071	AN I				2 C4617 L	G3346178		1-	A	D6
1072	AN I				2 C5006- 1	G3350068		1-	B	5
1073	AN I				2 C5006- 1	G3350068		1-	B	5
1074	AN I				2 C5006- 1	G3350068		1-	A	D5
1075	AN I				2 C5006- 1	G3350068		1-	A	D5
1076	AN I				2 C5374- L	G3353748		1-	B	5
1077	AN I				2 C5374- L	G3353748		1-	B	5
1078	AN I				2 C5374- L	G3353748		1-	A	E5
1079	AN I				D C144EE L	G3070075		1-	B	4
1080	AN I				D C144EE L	G3070075		1-	B	4
1081	IC				NJM2904 - E1	G1091677		1-	B	4
1082	AN I				D A144EE L	G3070074		1-	B	3
1083	AN I				D C144EE L	G3070075		1-	B	4
1084	FE				2 K2596B L	G3825967		1-	A	D4
1085	AN I				2 D1664 100	G3416647		1-	B	4
1086	FE				D07M 1(A E)	G3070320		1-	A	D3
1087	FE				D70H F1	G3090140		1-	A	E2
1088	AN I				D A144EE L	G3070074		1-	B	7
1002	CHI E .	100	1/16	0.5%	0510 -104-D	J24189167		1-	A	G4
1003	CHI E .	82	1/16	0.5%	0510 -823-D	J24189165		1-	A	G4
1004	CHI E .	10	1/16	0.5%	0510 -103-D	J24189143	A	1-	B	4
1004	CHI E .	10	1/16	0.5%	0510 -103-D	J24189143	E	1-	B	4

*: E E ANDA D.

MAIN Unit

Parts List

REF	DESCRIPTION	VALUE	V/W	TOL.	MFR'S DESIG	VXSTD P/N	VERS.	LOT	SIDE	LAY ADR
R 1004	CHIP RES.	10k	1/16W	0.5%	RR0510P-103-D	J24189143	USA	1-	B	c4
R 1005	CHIP RES.	47k	1/16W	5%	RMC1/16S 473JTH	J24189045		1-	B	c4
R 1007	CHIP RES.	15k	1/16W	0.5%	RR0510R-153-D	J24189147	AUS	1-	A	F4
R 1007	CHIP RES.	15k	1/16W	0.5%	RR0510R-153-D	J24189147	EXP	1-	A	F4
R 1007	CHIP RES.	15k	1/16W	0.5%	RR0510R-153-D	J24189147	USA	1-	A	F4
R 1008	CHIP RES.	100k	1/16W	5%	RMC1/16S 104JTH	J24189049		1-	A	F4
R 1009	CHIP RES.	100	1/16W	5%	RMC1/16S 101JTH	J24189013		1-	B	c4
R 1011	CHIP RES.	4.7k	1/16W	5%	RMC1/16S 472JTH	J24189033		1-	B	c5
R 1012	CHIP RES.	100	1/16W	5%	RMC1/16S 101JTH	J24189013		1-	B	c5
R 1013	CHIP RES.	100k	1/16W	5%	RMC1/16S 104JTH	J24189049		1-	B	c5
R 1014	CHIP RES.	100k	1/16W	5%	RMC1/16S 104JTH	J24189049		1-	B	d5
R 1015	CHIP RES.	100k	1/16W	5%	RMC1/16S 104JTH	J24189049		1-	B	d5
R 1016	CHIP RES.	33k	1/16W	5%	RMC1/16S 333JTH	J24189043		1-	B	d5
R 1017	CHIP RES.	220k	1/16W	5%	RMC1/16S 224JTH	J24189053		1-	B	d5
R 1018	CHIP RES.	150	1/16W	5%	RMC1/16S 151JTH	J24189015		1-	B	d4
R 1019	CHIP RES.	1k	1/16W	5%	RMC1/16S 102JTH	J24189025		1-	B	d5
R 1020	CHIP RES.	100	1/16W	5%	RMC1/16S 101JTH	J24189013		1-	B	d5
R 1021	CHIP RES.	0	1/16W	5%	RMC1/16S JPTH	J24189070		1-	B	c4
R 1022	CHIP RES.	4.7k	1/16W	5%	RMC1/16S 472JTH	J24189033		1-	A	F5
R 1023	CHIP RES.	100	1/16W	5%	RMC1/16S 101JTH	J24189013		1-	A	F5
R 1024	CHIP RES.	1M	1/16W	5%	RMC1/16S 105JTH	J24189061		1-	A	E5
R 1025	CHIP RES.	47k	1/16W	5%	RMC1/16S 473JTH	J24189045		1-	A	F5
R 1026	CHIP RES.	1k	1/16W	5%	RMC1/16S 102JTH	J24189025		1-	A	E5
R 1027	CHIP RES.	1k	1/16W	5%	RMC1/16S 102JTH	J24189025		1-	B	d5
R 1028	CHIP RES.	47k	1/16W	5%	RMC1/16S 473JTH	J24189045		1-	B	d5
R 1029	CHIP RES.	220k	1/16W	5%	RMC1/16S 224JTH	J24189053		1-	B	d5
R 1030	CHIP RES.	47	1/16W	5%	RMC1/16S 470JTH	J24189009		1-	A	E4
R 1031	CHIP RES.	82k	1/16W	0.5%	RR0510R-823-D	J24189165		1-	A	G4
R 1035	CHIP RES.	4.7k	1/16W	5%	RMC1/16S 472JTH	J24189033		1-	B	b3
R 1036	CHIP RES.	47k	1/16W	5%	RMC1/16S 473JTH	J24189045		1-	B	b4
R 1037	CHIP RES.	10k	1/16W	5%	RMC1/16S 103JTH	J24189037		1-	B	b4
R 1038	CHIP RES.	15	1/16W	5%	RMC1/16S 150JTH	J24189003	AUS	1-	B	c4
R 1038	CHIP RES.	15	1/16W	5%	RMC1/16S 150JTH	J24189003	EXP	1-	B	c4
R 1038	CHIP RES.	15	1/16W	5%	RMC1/16S 150JTH	J24189003	USA	1-	B	c4
R 1039	CHIP RES.	47	1/16W	5%	RMC1/16S 470JTH	J24189009		1-	B	c4
R 1040	CHIP RES.	2.2k	1/16W	5%	RMC1/16S 222JTH	J24189029	AUS	1-	B	c5
R 1040	CHIP RES.	2.2k	1/16W	5%	RMC1/16S 222JTH	J24189029	EXP	1-	B	c5
R 1040	CHIP RES.	2.2k	1/16W	5%	RMC1/16S 222JTH	J24189029	USA	1-	B	c5
R 1041	CHIP RES.	0	1/16W	5%	RMC1/16S JPTH	J24189070	AUS	1-	B	c5
R 1041	CHIP RES.	0	1/16W	5%	RMC1/16S JPTH	J24189070	EXP	1-	B	c5
R 1041	CHIP RES.	0	1/16W	5%	RMC1/16S JPTH	J24189070	USA	1-	B	c5
R 1042	CHIP RES.	220k	1/16W	5%	RMC1/16S 224JTH	J24189053		1-	B	c5
R 1043	CHIP RES.	220k	1/16W	5%	RMC1/16S 224JTH	J24189053		1-	B	d5
R 1044	CHIP RES.	220k	1/16W	5%	RMC1/16S 224JTH	J24189053		1-	B	d5
R 1045	CHIP RES.	15k	1/16W	5%	RMC1/16S 153JTH	J24189039		1-	B	d5
R 1046	CHIP RES.	120k	1/16W	5%	RMC1/16S 124JTH	J24189050		1-	B	d5
R 1047	CHIP RES.	47k	1/16W	5%	RMC1/16S 473JTH	J24189045		1-	B	d5
R 1048	CHIP RES.	220k	1/16W	5%	RMC1/16S 224JTH	J24189053		1-	B	d5
R 1049	CHIP RES.	150	1/16W	5%	RMC1/16S 151JTH	J24189015		1-	B	d5
R 1050	CHIP RES.	470	1/16W	5%	RMC1/16S 471JTH	J24189021		1-	B	d5
R 1051	CHIP RES.	4.7k	1/16W	5%	RMC1/16S 472JTH	J24189033		1-	B	b3
R 1054	CHIP RES.	47k	1/16W	5%	RMC1/16S 473JTH	J24189045		1-	B	b4
R 1055	CHIP RES.	10k	1/16W	0.5%	RR0510P-103-D	J24189143		1-	A	G4
R 1056	CHIP RES.	10k	1/16W	5%	RMC1/16S 103JTH	J24189037		1-	B	b4
R 1057	CHIP RES.	47	1/16W	5%	RMC1/16S 470JTH	J24189009	AUS	1-	B	b4
R 1057	CHIP RES.	47	1/16W	5%	RMC1/16S 470JTH	J24189009	EXP	1-	B	b4
R 1057	CHIP RES.	47	1/16W	5%	RMC1/16S 470JTH	J24189009	USA	1-	B	b4
R 1058	CHIP RES.	47	1/16W	5%	RMC1/16S 470JTH	J24189009		1-	B	b4
R 1059	CHIP RES.	100	1/16W	5%	RMC1/16S 101JTH	J24189013		1-	B	c5
R 1060	CHIP RES.	470	1/16W	5%	RMC1/16S 471JTH	J24189021		1-	B	c5
R 1061	CHIP RES.	47k	1/16W	5%	RMC1/16S 473JTH	J24189045		1-	B	c5
R 1062	CHIP RES.	1.5M	1/16W	5%	RMC1/16S 155JTH	J24189063		1-	B	d5
R 1063	CHIP RES.	470	1/16W	5%	RMC1/16S 471JTH	J24189021		1-	B	d5
R 1064	CHIP RES.	4.7k	1/16W	5%	RMC1/16S 472JTH	J24189033		1-	B	d5
R 1065	CHIP RES.	4.7k	1/16W	5%	RMC1/16S 472JTH	J24189033		1-	B	b2
R 1066	CHIP RES.	330k	1/16W	5%	RMC1/16S 334JTH	J24189055		1-	A	H5
R 1067	CHIP RES.	22	1/16W	5%	RMC1/16S 220JTH	J24189005		1-	A	H5
R 1068	CHIP RES.	100	1/16W	5%	RMC1/16S 101JTH	J24189013		1-	A	H5
R 1069	CHIP RES.	820k	1/16W	5%	RMC1/16S 824JTH	J24189060		1-	A	G5
R 1070	CHIP RES.	100	1/16W	5%	RMC1/16S 101JTH	J24189013		1-	A	G5
R 1071	CHIP RES.	100	1/16W	5%	RMC1/16S 101JTH	J24189013		1-	A	G4
R 1072	CHIP RES.	100	1/16W	5%	RMC1/16S 101JTH	J24189013		1-	A	F4
R 1073	CHIP RES.	47k	1/16W	5%	RMC1/16S 473JTH	J24189045		1-	A	G5

MAIN Unit

Parts List

REF	DESCRIPTION	VALUE	V/W	TOL.	MFR'S DESIG	VXSTD P/N	VERS.	LOT	SIDE	LAY ADR
R 1074	CHIP RES.	560k	1/16W	5%	RMC1/16S 564JTH	J24189058		1-	A	F5
R 1075	CHIP RES.	100	1/16W	5%	RMC1/16S 101JTH	J24189013		1-	A	E5
R 1076	CHIP RES.	1k	1/16W	5%	RMC1/16S 102JTH	J24189025		1-	A	E5
R 1077	CHIP RES.	22	1/16W	5%	RMC1/16S 220JTH	J24189005		1-	A	E4
R 1078	CHIP RES.	100	1/16W	5%	RMC1/16S 101JTH	J24189013		1-	A	E5
R 1080	CHIP RES.	2.2k	1/16W	5%	RMC1/16S 222JTH	J24189029		1-	A	F6
R 1081	CHIP RES.	100	1/16W	5%	RMC1/16S 101JTH	J24189013		1-	A	E6
R 1082	CHIP RES.	100	1/16W	5%	RMC1/16S 101JTH	J24189013		1-	A	F6
R 1083	CHIP RES.	560	1/16W	5%	RMC1/16S 561JTH	J24189022		1-	A	F7
R 1084	CHIP RES.	330k	1/16W	5%	RMC1/16S 334JTH	J24189055		1-	A	F7
R 1085	CHIP RES.	8.2k	1/16W	0.5%	RR0510P-822-D	J24189141	AUSA	1-	A	F7
R 1085	CHIP RES.	8.2k	1/16W	0.5%	RR0510P-822-D	J24189141	EXP	1-	A	F7
R 1085	CHIP RES.	8.2k	1/16W	0.5%	RR0510P-822-D	J24189141	USA	1-	A	F7
R 1086	CHIP RES.	330	1/16W	5%	RMC1/16S 331JTH	J24189019		1-	A	E7
R 1087	CHIP RES.	220	1/16W	5%	RMC1/16S 221JTH	J24189017		1-	A	E7
R 1088	CHIP RES.	470	1/16W	5%	RMC1/16S 471JTH	J24189021		1-	A	E7
R 1089	CHIP RES.	100	1/16W	5%	RMC1/16S 101JTH	J24189013		1-	A	E7
R 1090	CHIP RES.	10	1/16W	5%	RMC1/16S 100JTH	J24189001		1-	A	E7
R 1091	CHIP RES.	100	1/16W	5%	RMC1/16S 101JTH	J24189013		1-	B	e7
R 1092	CHIP RES.	150k	1/16W	5%	RMC1/16S 154JTH	J24189051		1-	B	e7
R 1093	CHIP RES.	10k	1/16W	0.5%	RR0510P-103-D	J24189143		1-	A	E7
R 1094	CHIP RES.	100k	1/16W	5%	RMC1/16S 104JTH	J24189049		1-	B	e7
R 1095	CHIP RES.	22k	1/16W	5%	RMC1/16S 223JTH	J24189041		1-	B	e7
R 1096	CHIP RES.	390k	1/16W	5%	RMC1/16S 394JTH	J24189056		1-	B	e6
R 1097	CHIP RES.	1k	1/16W	5%	RMC1/16S 102JTH	J24189025		1-	B	f7
R 1098	CHIP RES.	2.7k	1/16W	5%	RMC1/16S 272JTH	J24189030		1-	B	e6
R 1099	CHIP RES.	330k	1/16W	5%	RMC1/16S 334JTH	J24189055		1-	A	D7
R 1100	CHIP RES.	47k	1/16W	5%	RMC1/16S 473JTH	J24189045		1-	B	f7
R 1101	CHIP RES.	4.7k	1/16W	5%	RMC1/16S 472JTH	J24189033		1-	A	D7
R 1102	CHIP RES.	1M	1/16W	5%	RMC1/16S 105JTH	J24189061		1-	A	D7
R 1103	CHIP RES.	470	1/16W	5%	RMC1/16S 471JTH	J24189021		1-	A	D7
R 1104	CHIP RES.	4.7k	1/16W	5%	RMC1/16S 472JTH	J24189033		1-	A	D7
R 1105	CHIP RES.	1M	1/16W	5%	RMC1/16S 105JTH	J24189061		1-	A	D7
R 1106	CHIP RES.	220	1/16W	5%	RMC1/16S 221JTH	J24189017		1-	A	D7
R 1107	CHIP RES.	1k	1/16W	5%	RMC1/16S 102JTH	J24189025		1-	B	e6
R 1108	CHIP RES.	4.7k	1/16W	5%	RMC1/16S 472JTH	J24189033		1-	B	e6
R 1109	CHIP RES.	100k	1/16W	5%	RMC1/16S 104JTH	J24189049		1-	A	D7
R 1110	CHIP RES.	1k	1/16W	5%	RMC1/16S 102JTH	J24189025		1-	B	g5
R 1111	CHIP RES.	68k	1/16W	0.5%	RR0510R-683-D	J24189163		1-	B	g4
R 1112	CHIP RES.	100k	1/16W	0.5%	RR0510R-104-D	J24189167		1-	B	g3
R 1113	CHIP RES.	10k	1/16W	5%	RMC1/16S 103JTH	J24189037		1-	B	g4
R 1114	CHIP RES.	100k	1/16W	5%	RMC1/16S 104JTH	J24189049		1-	B	g4
R 1115	CHIP RES.	1k	1/16W	5%	RMC1/16S 102JTH	J24189025		1-	B	d7
R 1116	CHIP RES.	1M	1/16W	5%	RMC1/16S 105JTH	J24189061		1-	B	d6
R 1117	CHIP RES.	470k	1/16W	5%	RMC1/16S 474JTH	J24189057		1-	B	d6
R 1118	CHIP RES.	1.5k	1/16W	0.5%	RR0510P-152-D	J24189123		1-	B	e7
R 1119	CHIP RES.	100k	1/16W	5%	RMC1/16S 104JTH	J24189049		1-	A	E7
R 1121	CHIP RES.	1k	1/16W	5%	RMC1/16S 102JTH	J24189025		1-	A	E7
R 1122	CHIP RES.	100k	1/16W	5%	RMC1/16S 104JTH	J24189049		1-	A	B7
R 1123	CHIP RES.	47k	1/16W	0.5%	RR0510R-473-D	J24189159		1-	B	e7
R 1124	CHIP RES.	2.7k	1/16W	0.5%	RR0510P-272-D	J24189129		1-	B	e7
R 1125	CHIP RES.	3.3k	1/16W	0.5%	RR0510P-332-D	J24189131		1-	B	e7
R 1126	CHIP RES.	150k	1/16W	5%	RMC1/16S 154JTH	J24189051		1-	B	e7
R 1127	CHIP RES.	220	1/16W	5%	RMC1/16S 221JTH	J24189017		1-	A	E7
R 1128	CHIP RES.	47	1/16W	5%	RMC1/16S 470JTH	J24189009		1-	A	D7
R 1129	CHIP RES.	1k	1/16W	5%	RMC1/16S 102JTH	J24189025		1-	B	d6
R 1130	CHIP RES.	4.7k	1/16W	5%	RMC1/16S 472JTH	J24189033		1-	B	e6
R 1135	CHIP RES.	22k	1/16W	5%	RMC1/16S 223JTH	J24189041		1-	B	e6
R 1136	CHIP RES.	22k	1/16W	5%	RMC1/16S 223JTH	J24189041		1-	B	e6
R 1138	CHIP RES.	68k	1/16W	5%	RMC1/16S 683JTH	J24189047		1-	B	h6
R 1139	CHIP RES.	10k	1/16W	0.5%	RR0510P-103-D	J24189143		1-	B	g5
R 1140	CHIP RES.	330k	1/16W	5%	RMC1/16S 334JTH	J24189055		1-	B	g5
R 1141	CHIP RES.	470k	1/16W	5%	RMC1/16S 474JTH	J24189057		1-	B	g6
R 1143	CHIP RES.	330k	1/16W	5%	RMC1/16S 334JTH	J24189055		1-	B	h5
R 1144	CHIP RES.	68k	1/16W	0.5%	RR0510R-683-D	J24189163		1-	B	h6
R 1145	CHIP RES.	39k	1/16W	5%	RMC1/16S 393JTH	J24189044		1-	B	h5
R 1146	CHIP RES.	220k	1/16W	5%	RMC1/16S 224JTH	J24189053		1-	B	h5
R 1147	CHIP RES.	10k	1/16W	5%	RMC1/16S 103JTH	J24189037		1-	B	h5
R 1148	CHIP RES.	1k	1/16W	5%	RMC1/16S 102JTH	J24189025		1-	B	h5
R 1149	CHIP RES.	27k	1/16W	5%	RMC1/16S 273JTH	J24189042		1-	B	g5
R 1150	CHIP RES.	390k	1/16W	5%	RMC1/16S 394JTH	J24189056		1-	B	h5
R 1151	CHIP RES.	150k	1/16W	5%	RMC1/16S 154JTH	J24189051		1-	B	h5
R 1152	CHIP RES.	100k	1/16W	5%	RMC1/16S 104JTH	J24189049		1-	B	h5

MAIN Unit

Parts List

REF	DESCRIPTION	VALUE	V/W	TOL.	MFR'S DESIG	VXSTD P/N	VERS.	LOT	SIDE	LAY ADR
R 1153	CHIP RES.	10k	1/16W	5%	RMC1/16S 103JTH	J24189037		1-	A	B3
R 1154	CHIP RES.	220k	1/16W	5%	RMC1/16S 224JTH	J24189053		1-	A	B3
R 1155	CHIP RES.	220k	1/16W	5%	RMC1/16S 224JTH	J24189053		1-	A	B3
R 1156	CHIP RES.	4.7k	1/16W	5%	RMC1/16S 472JTH	J24189033		1-	A	A1
R 1157	CHIP RES.	220	1/16W	5%	RMC1/16S 221JTH	J24189017		1-	A	A1
R 1158	CHIP RES.	4.7k	1/16W	5%	RMC1/16S 472JTH	J24189033		1-	A	B3
R 1159	CHIP RES.	220k	1/16W	5%	RMC1/16S 224JTH	J24189053		1-	A	B3
R 1160	CHIP RES.	220k	1/16W	5%	RMC1/16S 224JTH	J24189053		1-	A	B3
R 1161	CHIP RES.	1k	1/16W	5%	RMC1/16S 102JTH	J24189025		1-	A	B3
R 1163	CHIP RES.	4.7k	1/16W	5%	RMC1/16S 472JTH	J24189033		1-	A	B3
R 1164	CHIP RES.	10k	1/16W	5%	RMC1/16S 103JTH	J24189037		1-	A	B5
R 1165	CHIP RES.	1M	1/16W	5%	RMC1/16S 105JTH	J24189061		1-	B	h5
R 1167	CHIP RES.	22k	1/16W	5%	RMC1/16S 223JTH	J24189041		1-	B	h5
R 1168	CHIP RES.	47k	1/16W	5%	RMC1/16S 473JTH	J24189045		1-	B	h5
R 1169	CHIP RES.	100k	1/16W	5%	RMC1/16S 104JTH	J24189049		1-	B	h5
R 1170	CHIP RES.	10k	1/16W	5%	RMC1/16S 103JTH	J24189037		1-	B	h6
R 1171	CHIP RES.	100k	1/16W	5%	RMC1/16S 104JTH	J24189049		1-	B	h5
R 1172	CHIP RES.	470k	1/16W	5%	RMC1/16S 474JTH	J24189057	USA	1-	B	h5
R 1173	CHIP RES.	2.7k	1/16W	5%	RMC1/16S 272JTH	J24189030	USA	1-	B	h5
R 1174	CHIP RES.	10k	1/16W	5%	RMC1/16S 103JTH	J24189037		1-	B	h5
R 1175	CHIP RES.	47k	1/16W	5%	RMC1/16S 473JTH	J24189045		1-	B	h5
R 1176	CHIP RES.	47k	1/16W	5%	RMC1/16S 473JTH	J24189045		1-	B	h5
R 1177	CHIP RES.	3.3M	1/16W	5%	RMC1/16S 335JTH	J24189324		1-	B	h5
R 1178	CHIP RES.	390k	1/16W	5%	RMC1/16S 394JTH	J24189056		1-	B	i5
R 1179	CHIP RES.	390k	1/16W	5%	RMC1/16S 394JTH	J24189056		1-	B	i5
R 1180	CHIP RES.	47k	1/16W	5%	RMC1/16S 473JTH	J24189045		1-	B	i6
R 1181	CHIP RES.	390k	1/16W	5%	RMC1/16S 394JTH	J24189056		1-	B	i6
R 1182	CHIP RES.	390k	1/16W	5%	RMC1/16S 394JTH	J24189056		1-	B	h6
R 1183	CHIP RES.	68k	1/16W	5%	RMC1/16S 683JTH	J24189047		1-	B	h6
R 1184	CHIP RES.	68k	1/16W	5%	RMC1/16S 683JTH	J24189047		1-	B	h6
R 1185	CHIP RES.	47	1/16W	5%	RMC1/16S 470JTH	J24189009		1-	A	A2
R 1186	CHIP RES.	100k	1/16W	5%	RMC1/16S 104JTH	J24189049		1-	B	h4
R 1187	CHIP RES.	100k	1/16W	5%	RMC1/16S 104JTH	J24189049		1-	A	B3
R 1188	CHIP RES.	100	1/16W	5%	RMC1/16S 101JTH	J24189013		1-	B	h2
R 1189	CHIP RES.	10	1/16W	5%	RMC1/16S 100JTH	J24189001		1-	B	i3
R 1190	CHIP RES.	10	1/16W	5%	RMC1/16S 100JTH	J24189001		1-	B	i3
R 1191	CHIP RES.	10k	1/16W	5%	RMC1/16S 103JTH	J24189037		1-	A	A3
R 1192	CHIP RES.	10k	1/16W	5%	RMC1/16S 103JTH	J24189037		1-	B	h2
R 1193	CHIP RES.	10k	1/16W	5%	RMC1/16S 103JTH	J24189037		1-	B	h2
R 1194	CHIP RES.	2.2M	1/16W	5%	RMC1/16S 225JTH	J24189065		1-	B	h2
R 1195	CHIP RES.	1k	1/16W	5%	RMC1/16S 102JTH	J24189025		1-	A	B1
R 1196	CHIP RES.	10	1/2W	5%	RMC1/2 100JCTP	J24275100		1-	A	A4
R 1197	CHIP RES.	10	1/2W	5%	RMC1/2 100JCTP	J24275100		1-	A	A4
R 1198	CHIP RES.	22k	1/16W	5%	RMC1/16S 223JTH	J24189041		1-	B	h6
R 1199	CHIP RES.	100k	1/16W	5%	RMC1/16S 104JTH	J24189049		1-	A	B5
R 1200	CHIP RES.	2.2M	1/16W	5%	RMC1/16S 225JTH	J24189065		1-	A	B5
R 1201	CHIP RES.	220	1/16W	5%	RMC1/16S 221JTH	J24189017		1-	A	B6
R 1202	CHIP RES.	4.7k	1/16W	5%	RMC1/16S 472JTH	J24189033		1-	A	A1
R 1203	CHIP RES.	4.7k	1/16W	5%	RMC1/16S 472JTH	J24189033		1-	A	B1
R 1204	CHIP RES.	680k	1/16W	5%	RMC1/16S 684JTH	J24189059		1-	A	B1
R 1205	CHIP RES.	470k	1/16W	5%	RMC1/16S 474JTH	J24189057		1-	A	B1
R 1206	CHIP RES.	22k	1/16W	5%	RMC1/16S 223JTH	J24189041		1-	A	B1
R 1207	CHIP RES.	47	1/16W	5%	RMC1/16S 470JTH	J24189009		1-	B	h5
R 1208	CHIP RES.	220k	1/16W	5%	RMC1/16S 224JTH	J24189053		1-	A	B5
R 1209	CHIP RES.	100k	1/16W	5%	RMC1/16S 104JTH	J24189049		1-	A	B5
R 1210	CHIP RES.	56k	1/16W	0.5%	RR0510R-563-D	J24189161		1-	A	B5
R 1211	CHIP RES.	100k	1/16W	0.5%	RR0510R-104-D	J24189167		1-	A	B5
R 1212	CHIP RES.	100k	1/16W	0.5%	RR0510R-104-D	J24189167		1-	A	A5
R 1213	CHIP RES.	2.2k	1/16W	5%	RMC1/16S 222JTH	J24189029		1-	A	B5
R 1214	CHIP RES.	39k	1/16W	5%	RMC1/16S 393JTH	J24189044		1-	A	B5
R 1215	CHIP RES.	10k	1/16W	5%	RMC1/16S 103JTH	J24189037		1-	A	B5
R 1216	CHIP RES.	100k	1/16W	5%	RMC1/16S 104JTH	J24189049		1-	B	f6
R 1217	CHIP RES.	33	1/2W	5%	RMC1/2 330JCTP	J24275330		1-	B	g2
R 1218	CHIP RES.	4.7k	1/16W	5%	RMC1/16S 472JTH	J24189033		1-	B	g1
R 1219	CHIP RES.	1k	1/16W	5%	RMC1/16S 102JTH	J24189025		1-	B	g7
R 1220	CHIP RES.	1k	1/16W	5%	RMC1/16S 102JTH	J24189025		1-	B	g7
R 1221	CHIP RES.	1k	1/16W	5%	RMC1/16S 102JTH	J24189025		1-	B	f7
R 1222	CHIP RES.	1k	1/16W	5%	RMC1/16S 102JTH	J24189025		1-	B	f6
R 1223	CHIP RES.	1k	1/16W	5%	RMC1/16S 102JTH	J24189025		1-	A	B6
R 1224	CHIP RES.	47k	1/16W	5%	RMC1/16S 473JTH	J24189045		1-	B	g7
R 1225	CHIP RES.	4.7k	1/16W	5%	RMC1/16S 472JTH	J24189033		1-	A	B2
R 1226	CHIP RES.	220	1/16W	5%	RMC1/16S 221JTH	J24189017		1-	A	B2
R 1227	CHIP RES.	220	1/16W	5%	RMC1/16S 221JTH	J24189017		1-	A	B2

MAIN Unit

Parts List

REF	DESCRIPTION	VALUE	V/W	TOL.	MFR'S DESIG	VXSTD P/N	VERS.	LOT	SIDE	LAY ADR
R 1228	CHIP RES.	220	1/16W	5%	RMC1/16S 221JTH	J24189017		1-	A	B2
R 1229	CHIP RES.	220	1/16W	5%	RMC1/16S 221JTH	J24189017		1-	A	B2
R 1230	CHIP RES.	0	1/16W	5%	RMC1/16S JPTH	J24189070		1-	B	g4
R 1231	CHIP RES.	22k	1/16W	5%	RMC1/16S 223JTH	J24189041		1-	A	B2
R 1232	CHIP RES.	47k	1/16W	5%	RMC1/16S 473JTH	J24189045		1-	A	B2
R 1235	CHIP RES.	5.6k	1/16W	5%	RMC1/16S 562JTH	J24189034		1-	B	h4
R 1236	CHIP RES.	15k	1/16W	5%	RMC1/16S 153JTH	J24189039		1-	B	h4
R 1237	CHIP RES.	10k	1/16W	5%	RMC1/16S 103JTH	J24189037		1-	B	h5
R 1238	CHIP RES.	220k	1/16W	5%	RMC1/16S 224JTH	J24189053		1-	B	h5
R 1239	CHIP RES.	100k	1/16W	0.5%	RR0510R-104-D	J24189167		1-	B	h4
R 1240	CHIP RES.	22k	1/16W	5%	RMC1/16S 223JTH	J24189041		1-	B	i4
R 1241	CHIP RES.	47k	1/16W	5%	RMC1/16S 473JTH	J24189045		1-	B	h5
R 1242	CHIP RES.	470k	1/16W	5%	RMC1/16S 474JTH	J24189057		1-	B	i5
R 1243	CHIP RES.	470k	1/16W	5%	RMC1/16S 474JTH	J24189057		1-	B	i5
R 1244	CHIP RES.	47k	1/16W	5%	RMC1/16S 473JTH	J24189045		1-	B	h6
R 1245	CHIP RES.	470	1/16W	5%	RMC1/16S 471JTH	J24189021		1-	B	h6
R 1246	CHIP RES.	1M	1/16W	5%	RMC1/16S 105JTH	J24189061		1-	B	h6
R 1247	CHIP RES.	1k	1/16W	5%	RMC1/16S 102JTH	J24189025		1-	B	h6
R 1248	CHIP RES.	22k	1/16W	5%	RMC1/16S 223JTH	J24189041		1-	B	h7
R 1249	CHIP RES.	1k	1/16W	5%	RMC1/16S 102JTH	J24189025		1-	B	h6
R 1250	CHIP RES.	2.2M	1/16W	5%	RMC1/16S 225JTH	J24189065		1-	A	A5
R 1251	CHIP RES.	4.7k	1/16W	5%	RMC1/16S 472JTH	J24189033		1-	A	A5
R 1252	CHIP RES.	22k	1/16W	5%	RMC1/16S 223JTH	J24189041		1-	A	A5
R 1253	CHIP RES.	3.9k	1/16W	5%	RMC1/16S 392JTH	J24189032		1-	A	A5
R 1254	CHIP RES.	100k	1/16W	5%	RMC1/16S 104JTH	J24189049		1-	A	A5
R 1255	CHIP RES.	220k	1/16W	5%	RMC1/16S 224JTH	J24189053		1-	A	A5
R 1256	CHIP RES.	220k	1/16W	5%	RMC1/16S 224JTH	J24189053		1-	A	A5
R 1257	CHIP RES.	330k	1/16W	5%	RMC1/16S 334JTH	J24189055		1-	A	A5
R 1258	CHIP RES.	10k	1/16W	5%	RMC1/16S 103JTH	J24189037		1-	A	A5
R 1259	CHIP RES.	68k	1/16W	5%	RMC1/16S 683JTH	J24189047		1-	A	B5
R 1260	CHIP RES.	68k	1/16W	5%	RMC1/16S 683JTH	J24189047		1-	B	h6
R 1261	CHIP RES.	390k	1/16W	5%	RMC1/16S 394JTH	J24189056	AUS	1-	A	B6
R 1261	CHIP RES.	390k	1/16W	5%	RMC1/16S 394JTH	J24189056	EXP	1-	A	B6
R 1261	CHIP RES.	330k	1/16W	5%	RMC1/16S 334JTH	J24189055	USA	1-	A	B6
R 1262	CHIP RES.	150k	1/16W	5%	RMC1/16S 154JTH	J24189051		1-	A	B5
R 1263	CHIP RES.	150k	1/16W	5%	RMC1/16S 154JTH	J24189051		1-	A	B5
R 1264	CHIP RES.	10k	1/16W	5%	RMC1/16S 103JTH	J24189037		1-	A	B6
R 1265	CHIP RES.	33k	1/16W	0.5%	RR0510R-333-D	J24189155		1-	A	B6
R 1266	CHIP RES.	56k	1/16W	0.5%	RR0510R-563-D	J24189161		1-	A	B6
R 1267	CHIP RES.	1k	1/16W	5%	RMC1/16S 102JTH	J24189025		1-	A	B5
R 1268	CHIP RES.	10k	1/16W	5%	RMC1/16S 103JTH	J24189037		1-	A	B5
R 1269	CHIP RES.	1k	1/16W	5%	RMC1/16S 102JTH	J24189025		1-	B	g6
R 1270	CHIP RES.	100k	1/16W	5%	RMC1/16S 104JTH	J24189049		1-	A	H6
R 1271	CHIP RES.	100k	1/16W	5%	RMC1/16S 104JTH	J24189049		1-	A	G6
R 1272	CHIP RES.	2.2k	1/16W	5%	RMC1/16S 222JTH	J24189029		1-	A	G6
R 1273	CHIP RES.	2.2k	1/16W	5%	RMC1/16S 222JTH	J24189029		1-	A	G6
R 1274	CHIP RES.	1k	1/16W	5%	RMC1/16S 102JTH	J24189025		1-	A	G6
R 1275	CHIP RES.	8.2k	1/16W	5%	RMC1/16S 822JTH	J24189036		1-	A	F6
R 1276	CHIP RES.	15k	1/16W	5%	RMC1/16S 153JTH	J24189039		1-	A	F7
R 1277	CHIP RES.	15k	1/16W	0.5%	RR0510R-153-D	J24189147		1-	A	A7
R 1278	CHIP RES.	10k	1/16W	0.5%	RR0510P-103-D	J24189143		1-	A	A7
R 1279	CHIP RES.	100k	1/16W	0.5%	RR0510R-104-D	J24189167		1-	B	h7
R 1280	CHIP RES.	100k	1/16W	0.5%	RR0510R-104-D	J24189167		1-	B	h7
R 1281	CHIP RES.	100k	1/16W	0.5%	RR0510R-104-D	J24189167		1-	B	h7
R 1282	CHIP RES.	100k	1/16W	0.5%	RR0510R-104-D	J24189167		1-	A	A7
R 1283	CHIP RES.	100k	1/16W	0.5%	RR0510R-104-D	J24189167		1-	A	A7
R 1284	CHIP RES.	390k	1/16W	5%	RMC1/16S 394JTH	J24189056		1-	A	A7
R 1285	CHIP RES.	820k	1/16W	5%	RMC1/16S 824JTH	J24189060		1-	B	h7
R 1286	CHIP RES.	1.5M	1/16W	5%	RMC1/16S 155JTH	J24189063		1-	B	h7
R 1287	CHIP RES.	1k	1/16W	5%	RMC1/16S 102JTH	J24189025		1-	A	A6
R 1296	CHIP RES.	1k	1/16W	5%	RMC1/16S 102JTH	J24189025		1-	A	A6
R 1297	CHIP RES.	1k	1/16W	5%	RMC1/16S 102JTH	J24189025		1-	A	A6
R 1298	CHIP RES.	1k	1/16W	5%	RMC1/16S 102JTH	J24189025		1-	B	h7
R 1299	CHIP RES.	1k	1/16W	5%	RMC1/16S 102JTH	J24189025		1-	A	A6
R 1300	CHIP RES.	1k	1/16W	5%	RMC1/16S 102JTH	J24189025		1-	A	A6
R 1301	CHIP RES.	1k	1/16W	5%	RMC1/16S 102JTH	J24189025		1-	A	A6
R 1302	CHIP RES.	10k	1/16W	0.5%	RR0510P-103-D	J24189143		1-	A	A6
R 1303	CHIP RES.	15k	1/16W	0.5%	RR0510R-153-D	J24189147		1-	A	A6
R 1304	CHIP RES.	100k	1/16W	0.5%	RR0510R-104-D	J24189167		1-	A	A6
R 1305	CHIP RES.	100k	1/16W	0.5%	RR0510R-104-D	J24189167		1-	A	A6
R 1306	CHIP RES.	100k	1/16W	0.5%	RR0510R-104-D	J24189167		1-	A	A6
R 1307	CHIP RES.	100k	1/16W	0.5%	RR0510R-104-D	J24189167		1-	A	A6
R 1308	CHIP RES.	100k	1/16W	0.5%	RR0510R-104-D	J24189167		1-	A	A6

MAIN Unit

Parts List

REF	DESCRIPTION	VALUE	V/W	TOL.	MFR'S DESIG	VXSTD P/N	VERS.	LOT	SIDE	LAY ADR
R 1309	CHIP RES.	390k	1/16W	5%	RMC1/16S 394JTH	J24189056		1-	A	A6
R 1310	CHIP RES.	820k	1/16W	5%	RMC1/16S 824JTH	J24189060		1-	A	A6
R 1311	CHIP RES.	1.5M	1/16W	5%	RMC1/16S 155JTH	J24189063		1-	A	A6
R 1312	CHIP RES.	47k	1/16W	5%	RMC1/16S 473JTH	J24189045		1-	B	h6
R 1313	CHIP RES.	1k	1/16W	5%	RMC1/16S 102JTH	J24189025		1-	B	h6
R 1314	CHIP RES.	1.5M	1/16W	5%	RMC1/16S 155JTH	J24189063		1-	A	B6
R 1315	CHIP RES.	820k	1/16W	5%	RMC1/16S 824JTH	J24189060		1-	A	B6
R 1316	CHIP RES.	390k	1/16W	5%	RMC1/16S 394JTH	J24189056		1-	A	B6
R 1317	CHIP RES.	100k	1/16W	0.5%	RR0510R-104-D	J24189167		1-	A	B6
R 1318	CHIP RES.	100k	1/16W	0.5%	RR0510R-104-D	J24189167		1-	A	B6
R 1319	CHIP RES.	100k	1/16W	0.5%	RR0510R-104-D	J24189167		1-	A	B6
R 1320	CHIP RES.	100k	1/16W	0.5%	RR0510R-104-D	J24189167		1-	A	B6
R 1321	CHIP RES.	100k	1/16W	0.5%	RR0510R-104-D	J24189167		1-	A	B6
R 1322	CHIP RES.	47k	1/16W	5%	RMC1/16S 473JTH	J24189045		1-	B	g6
R 1323	CHIP RES.	100k	1/16W	0.5%	RR0510R-104-D	J24189167		1-	B	h4
R 1324	CHIP RES.	100k	1/16W	0.5%	RR0510R-104-D	J24189167		1-	B	h4
R 1325	CHIP RES.	100k	1/16W	0.5%	RR0510R-104-D	J24189167		1-	B	h7
R 1326	CHIP RES.	1k	1/16W	5%	RMC1/16S 102JTH	J24189025		1-	B	h7
R 1327	CHIP RES.	2.2k	1/16W	0.5%	RR0510P-222-D	J24189127		1-	A	B4
R 1328	CHIP RES.	1k	1/16W	5%	RMC1/16S 102JTH	J24189025		1-	A	B6
R 1329	CHIP RES.	1k	1/16W	5%	RMC1/16S 102JTH	J24189025		1-	A	B6
R 1331	CHIP RES.	1k	1/16W	5%	RMC1/16S 102JTH	J24189025		1-	A	B6
R 1332	CHIP RES.	1k	1/16W	5%	RMC1/16S 102JTH	J24189025		1-	A	B6
R 1333	CHIP RES.	1k	1/16W	5%	RMC1/16S 102JTH	J24189025		1-	A	B6
R 1334	CHIP RES.	1k	1/16W	5%	RMC1/16S 102JTH	J24189025		1-	A	B6
R 1335	CHIP RES.	1k	1/16W	5%	RMC1/16S 102JTH	J24189025		1-	A	B6
R 1336	CHIP RES.	100k	1/16W	5%	RMC1/16S 104JTH	J24189049		1-	A	B6
R 1337	CHIP RES.	1k	1/16W	5%	RMC1/16S 102JTH	J24189025		1-	A	B6
R 1338	CHIP RES.	1k	1/16W	5%	RMC1/16S 102JTH	J24189025		1-	B	g7
R 1339	CHIP RES.	1k	1/16W	5%	RMC1/16S 102JTH	J24189025		1-	B	g6
R 1340	CHIP RES.	1k	1/16W	5%	RMC1/16S 102JTH	J24189025		1-	B	g6
R 1341	CHIP RES.	1k	1/16W	5%	RMC1/16S 102JTH	J24189025		1-	B	h6
R 1342	CHIP RES.	10k	1/16W	5%	RMC1/16S 103JTH	J24189037		1-	B	h7
R 1343	CHIP RES.	1k	1/16W	5%	RMC1/16S 102JTH	J24189025		1-	A	B7
R 1344	CHIP RES.	100	1/16W	5%	RMC1/16S 101JTH	J24189013		1-	A	B7
R 1345	CHIP RES.	1k	1/16W	5%	RMC1/16S 102JTH	J24189025		1-	A	B7
R 1346	CHIP RES.	1k	1/16W	5%	RMC1/16S 102JTH	J24189025		1-	A	B7
R 1347	CHIP RES.	47k	1/16W	5%	RMC1/16S 473JTH	J24189045		1-	A	B7
R 1348	CHIP RES.	1k	1/16W	5%	RMC1/16S 102JTH	J24189025		1-	A	B7
R 1349	CHIP RES.	39k	1/16W	5%	RMC1/16S 393JTH	J24189044		1-	B	f6
R 1350	CHIP RES.	27k	1/16W	5%	RMC1/16S 273JTH	J24189042		1-	B	g6
R 1351	CHIP RES.	100k	1/16W	5%	RMC1/16S 104JTH	J24189049		1-	B	f6
R 1352	CHIP RES.	2.2k	1/16W	5%	RMC1/16S 222JTH	J24189029		1-	A	D5
R 1353	CHIP RES.	2.2k	1/16W	5%	RMC1/16S 222JTH	J24189029		1-	A	D5
R 1354	CHIP RES.	330	1/16W	5%	RMC1/16S 331JTH	J24189019		1-	A	D5
R 1355	CHIP RES.	150	1/16W	5%	RMC1/16S 151JTH	J24189015		1-	A	D5
R 1356	CHIP RES.	680	1/16W	5%	RMC1/16S 681JTH	J24189023		1-	A	D5
R 1357	CHIP RES.	82k	1/16W	5%	RMC1/16S 823JTH	J24189048		1-	B	g4
R 1358	CHIP RES.	100k	1/16W	5%	RMC1/16S 104JTH	J24189049		1-	A	B5
R 1359	CHIP RES.	100k	1/16W	5%	RMC1/16S 104JTH	J24189049		1-	B	g6
R 1360	CHIP RES.	47k	1/16W	5%	RMC1/16S 473JTH	J24189045		1-	B	f6
R 1361	CHIP RES.	10k	1/16W	5%	RMC1/16S 103JTH	J24189037		1-	B	e6
R 1362	CHIP RES.	22k	1/16W	5%	RMC1/16S 223JTH	J24189041		1-	A	C6
R 1363	CHIP RES.	100k	1/16W	5%	RMC1/16S 104JTH	J24189049		1-	A	C6
R 1364	CHIP RES.	680k	1/16W	5%	RMC1/16S 684JTH	J24189059		1-	A	D5
R 1365	CHIP RES.	100	1/16W	5%	RMC1/16S 101JTH	J24189013		1-	A	D5
R 1366	CHIP RES.	220k	1/16W	5%	RMC1/16S 224JTH	J24189053		1-	A	C6
R 1367	CHIP RES.	47	1/16W	5%	RMC1/16S 470JTH	J24189009		1-	A	D6
R 1368	CHIP RES.	100	1/16W	5%	RMC1/16S 101JTH	J24189013		1-	B	f6
R 1369	CHIP RES.	470k	1/16W	5%	RMC1/16S 474JTH	J24189057		1-	B	f6
R 1370	CHIP RES.	120k	1/16W	5%	RMC1/16S 124JTH	J24189050		1-	B	f6
R 1371	CHIP RES.	82k	1/16W	5%	RMC1/16S 823JTH	J24189048		1-	B	f6
R 1372	CHIP RES.	100k	1/16W	5%	RMC1/16S 104JTH	J24189049		1-	B	e6
R 1373	CHIP RES.	470k	1/16W	5%	RMC1/16S 474JTH	J24189057		1-	B	f6
R 1374	CHIP RES.	100k	1/16W	5%	RMC1/16S 104JTH	J24189049		1-	B	e6
R 1375	CHIP RES.	10k	1/16W	5%	RMC1/16S 103JTH	J24189037		1-	A	D6
R 1376	CHIP RES.	10k	1/16W	5%	RMC1/16S 103JTH	J24189037		1-	A	D6
R 1377	CHIP RES.	10k	1/16W	5%	RMC1/16S 103JTH	J24189037		1-	A	D6
R 1378	CHIP RES.	10k	1/16W	5%	RMC1/16S 103JTH	J24189037		1-	A	D5
R 1379	CHIP RES.	47k	1/16W	5%	RMC1/16S 473JTH	J24189045		1-	B	e6
R 1380	CHIP RES.	150k	1/16W	5%	RMC1/16S 154JTH	J24189051		1-	B	e6
R 1381	CHIP RES.	330k	1/16W	5%	RMC1/16S 334JTH	J24189055		1-	B	e6
R 1382	CHIP RES.	82k	1/16W	5%	RMC1/16S 823JTH	J24189048		1-	B	f6

MAIN Unit

Parts List

REF	DESCRIPTION	VALUE	V/W	TOL.	MFR'S DESIG	VXSTD P/N	VERS.	LOT	SIDE	LAY ADR
R 1383	CHIP RES.	18k	1/16W	5%	RMC1/16S 183JTH	J24189040		1-	B	f6
R 1384	CHIP RES.	4.7k	1/16W	5%	RMC1/16S 472JTH	J24189033		1-	A	D6
R 1385	CHIP RES.	18k	1/16W	5%	RMC1/16S 183JTH	J24189040		1-	A	D6
R 1386	CHIP RES.	56k	1/16W	5%	RMC1/16S 563JTH	J24189046		1-	A	C5
R 1387	CHIP RES.	10k	1/16W	5%	RMC1/16S 103JTH	J24189037		1-	A	E5
R 1388	CHIP RES.	100k	1/16W	5%	RMC1/16S 104JTH	J24189049		1-	B	e5
R 1389	CHIP RES.	220k	1/16W	5%	RMC1/16S 224JTH	J24189053		1-	B	e5
R 1390	CHIP RES.	150	1/16W	5%	RMC1/16S 151JTH	J24189015		1-	B	f5
R 1391	CHIP RES.	3.3k	1/16W	5%	RMC1/16S 332JTH	J24189031		1-	B	e5
R 1392	CHIP RES.	15k	1/16W	5%	RMC1/16S 153JTH	J24189039		1-	B	e5
R 1393	CHIP RES.	22k	1/16W	5%	RMC1/16S 223JTH	J24189041		1-	B	e5
R 1394	CHIP RES.	680	1/16W	5%	RMC1/16S 681JTH	J24189023		1-	B	f5
R 1395	CHIP RES.	47	1/16W	5%	RMC1/16S 470JTH	J24189009		1-	B	e5
R 1396	CHIP RES.	470	1/16W	5%	RMC1/16S 471JTH	J24189021		1-	B	e5
R 1397	CHIP RES.	33k	1/16W	5%	RMC1/16S 333JTH	J24189043		1-	B	e5
R 1398	CHIP RES.	47	1/16W	5%	RMC1/16S 470JTH	J24189009		1-	A	D5
R 1399	CHIP RES.	10k	1/16W	5%	RMC1/16S 103JTH	J24189037		1-	A	D5
R 1400	CHIP RES.	33k	1/16W	5%	RMC1/16S 333JTH	J24189043		1-	A	D5
R 1401	CHIP RES.	270	1/16W	5%	RMC1/16S 271JTH	J24189018		1-	B	e5
R 1402	CHIP RES.	470	1/16W	5%	RMC1/16S 471JTH	J24189021		1-	A	D5
R 1403	CHIP RES.	3.3k	1/16W	5%	RMC1/16S 332JTH	J24189031		1-	A	E5
R 1404	CHIP RES.	2.2k	1/16W	5%	RMC1/16S 222JTH	J24189029		1-	B	e5
R 1405	CHIP RES.	15k	1/16W	5%	RMC1/16S 153JTH	J24189039		1-	B	e5
R 1406	CHIP RES.	22k	1/16W	5%	RMC1/16S 223JTH	J24189041		1-	B	e5
R 1407	CHIP RES.	1k	1/16W	5%	RMC1/16S 102JTH	J24189025		1-	B	e5
R 1408	CHIP RES.	220	1/16W	5%	RMC1/16S 221JTH	J24189017		1-	B	e5
R 1409	CHIP RES.	1k	1/16W	5%	RMC1/16S 102JTH	J24189025		1-	B	e5
R 1410	CHIP RES.	100	1/16W	5%	RMC1/16S 101JTH	J24189013		1-	A	D5
R 1411	CHIP RES.	33k	1/16W	5%	RMC1/16S 333JTH	J24189043		1-	B	e5
R 1412	CHIP RES.	220	1/16W	5%	RMC1/16S 221JTH	J24189017		1-	A	D5
R 1413	CHIP RES.	47	1/16W	5%	RMC1/16S 470JTH	J24189009		1-	A	E5
R 1414	CHIP RES.	100k	1/16W	5%	RMC1/16S 104JTH	J24189049		1-	A	E5
R 1415	CHIP RES.	1k	1/16W	5%	RMC1/16S 102JTH	J24189025		1-	B	f4
R 1416	CHIP RES.	1k	1/16W	5%	RMC1/16S 102JTH	J24189025		1-	B	e4
R 1417	CHIP RES.	47k	1/16W	5%	RMC1/16S 473JTH	J24189045		1-	B	g4
R 1418	CHIP RES.	10	1/16W	5%	RMC1/16S 100JTH	J24189001		1-	A	D4
R 1419	CHIP RES.	1k	1/16W	5%	RMC1/16S 102JTH	J24189025		1-	B	g3
R 1420	CHIP RES.	1k	1/16W	5%	RMC1/16S 102JTH	J24189025		1-	B	c2
R 1421	CHIP RES.	330k	1/16W	5%	RMC1/16S 334JTH	J24189055		1-	B	g3
R 1422	CHIP RES.	100	1/16W	5%	RMC1/16S 101JTH	J24189013		1-	B	g3
R 1423	CHIP RES.	100	1/16W	5%	RMC1/16S 101JTH	J24189013		1-	B	g4
R 1424	CHIP RES.	3.3k	1/16W	5%	RMC1/16S 332JTH	J24189031		1-	B	g4
R 1425	CHIP RES.	150k	1/16W	5%	RMC1/16S 154JTH	J24189051		1-	B	g4
R 1426	CHIP RES.	2.2M	1/16W	5%	RMC1/16S 225JTH	J24189065	USA A2	1-	B	g4
R 1426	CHIP RES.	2.2M	1/16W	5%	RMC1/16S 225JTH	J24189065	VER. A1	1-	B	g4
R 1426	CHIP RES.	2.2M	1/16W	5%	RMC1/16S 225JTH	J24189065	VER. A2	1-	B	g4
R 1426	CHIP RES.	2.2M	1/16W	5%	RMC1/16S 225JTH	J24189065	VER. A3	1-	B	g4
R 1426	CHIP RES.	2.2M	1/16W	5%	RMC1/16S 225JTH	J24189065	VER. B1	1-	B	g4
R 1426	CHIP RES.	2.2M	1/16W	5%	RMC1/16S 225JTH	J24189065	VER. B2	1-	B	g4
R 1426	CHIP RES.	2.2M	1/16W	5%	RMC1/16S 225JTH	J24189065	VER. B3	1-	B	g4
R 1426	CHIP RES.	2.2M	1/16W	5%	RMC1/16S 225JTH	J24189065	VER. C1	1-	B	g4
R 1426	CHIP RES.	2.2M	1/16W	5%	RMC1/16S 225JTH	J24189065	VER. C2	1-	B	g4
R 1426	CHIP RES.	2.2M	1/16W	5%	RMC1/16S 225JTH	J24189065	VER. C3	1-	B	g4
R 1426	CHIP RES.	2.2M	1/16W	5%	RMC1/16S 225JTH	J24189065	VER. D1	1-	B	g4
R 1426	CHIP RES.	2.2M	1/16W	5%	RMC1/16S 225JTH	J24189065	VER. D2	1-	B	g4
R 1426	CHIP RES.	2.2M	1/16W	5%	RMC1/16S 225JTH	J24189065	VER. H1	1-	B	g4
R 1426	CHIP RES.	2.2M	1/16W	5%	RMC1/16S 225JTH	J24189065	VER. H2	1-	B	g4
R 1428	CHIP RES.	6.8k	1/16W	5%	RMC1/16S 682JTH	J24189035		1-	B	g3
R 1430	CHIP RES.	47	1/16W	5%	RMC1/16S 470JTH	J24189009		1-	B	e4
R 1431	CHIP RES.	150	1/16W	5%	RMC1/16S 151JTH	J24189015	USA A2	1-	B	e4
R 1431	CHIP RES.	150	1/16W	5%	RMC1/16S 151JTH	J24189015	VER. A1	1-	B	e4
R 1431	CHIP RES.	150	1/16W	5%	RMC1/16S 151JTH	J24189015	VER. A2	1-	B	e4
R 1431	CHIP RES.	150	1/16W	5%	RMC1/16S 151JTH	J24189015	VER. A3	1-	B	e4
R 1431	CHIP RES.	150	1/16W	5%	RMC1/16S 151JTH	J24189015	VER. B1	1-	B	e4
R 1431	CHIP RES.	150	1/16W	5%	RMC1/16S 151JTH	J24189015	VER. B2	1-	B	e4
R 1431	CHIP RES.	150	1/16W	5%	RMC1/16S 151JTH	J24189015	VER. B3	1-	B	e4
R 1431	CHIP RES.	150	1/16W	5%	RMC1/16S 151JTH	J24189015	VER. C1	1-	B	e4
R 1431	CHIP RES.	150	1/16W	5%	RMC1/16S 151JTH	J24189015	VER. C2	1-	B	e4
R 1431	CHIP RES.	150	1/16W	5%	RMC1/16S 151JTH	J24189015	VER. C3	1-	B	e4
R 1431	CHIP RES.	150	1/16W	5%	RMC1/16S 151JTH	J24189015	VER. D1	1-	B	e4
R 1431	CHIP RES.	150	1/16W	5%	RMC1/16S 151JTH	J24189015	VER. D2	1-	B	e4
R 1431	CHIP RES.	150	1/16W	5%	RMC1/16S 151JTH	J24189015	VER. H1	1-	B	e4
R 1431	CHIP RES.	150	1/16W	5%	RMC1/16S 151JTH	J24189015	VER. H2	1-	B	e4

MAIN Unit

Parts List

REF	DESCRIPTION	VALUE	V/W	TOL.	MFR'S DESIG	VXSTD P/N	VERS.	LOT	SIDE	LAY ADR
R 1432	CHIP RES.	47	1/16W	5%	RMC1/16S 470JTH	J24189009		1-	B	e4
R 1433	CHIP RES.	100	1/16W	5%	RMC1/16S 101JTH	J24189013		1-	B	e4
R 1434	CHIP RES.	0	1/16W	5%	RMC1/16S JPTH	J24189070	USA A2	1-	B	e4
R 1434	CHIP RES.	0	1/16W	5%	RMC1/16S JPTH	J24189070	VER. A1	1-	B	e4
R 1434	CHIP RES.	0	1/16W	5%	RMC1/16S JPTH	J24189070	VER. A2	1-	B	e4
R 1434	CHIP RES.	0	1/16W	5%	RMC1/16S JPTH	J24189070	VER. A3	1-	B	e4
R 1434	CHIP RES.	0	1/16W	5%	RMC1/16S JPTH	J24189070	VER. B1	1-	B	e4
R 1434	CHIP RES.	0	1/16W	5%	RMC1/16S JPTH	J24189070	VER. B2	1-	B	e4
R 1434	CHIP RES.	0	1/16W	5%	RMC1/16S JPTH	J24189070	VER. B3	1-	B	e4
R 1434	CHIP RES.	0	1/16W	5%	RMC1/16S JPTH	J24189070	VER. C1	1-	B	e4
R 1434	CHIP RES.	0	1/16W	5%	RMC1/16S JPTH	J24189070	VER. C2	1-	B	e4
R 1434	CHIP RES.	0	1/16W	5%	RMC1/16S JPTH	J24189070	VER. C3	1-	B	e4
R 1434	CHIP RES.	0	1/16W	5%	RMC1/16S JPTH	J24189070	VER. D1	1-	B	e4
R 1434	CHIP RES.	0	1/16W	5%	RMC1/16S JPTH	J24189070	VER. D2	1-	B	e4
R 1434	CHIP RES.	0	1/16W	5%	RMC1/16S JPTH	J24189070	VER. H1	1-	B	e4
R 1434	CHIP RES.	0	1/16W	5%	RMC1/16S JPTH	J24189070	VER. H2	1-	B	e4
R 1435	CHIP RES.	1k	1/16W	5%	RMC1/16S 102JTH	J24189025	USA A2	1-	B	e4
R 1435	CHIP RES.	1k	1/16W	5%	RMC1/16S 102JTH	J24189025	VER. A1	1-	B	e4
R 1435	CHIP RES.	1k	1/16W	5%	RMC1/16S 102JTH	J24189025	VER. A2	1-	B	e4
R 1435	CHIP RES.	1k	1/16W	5%	RMC1/16S 102JTH	J24189025	VER. A3	1-	B	e4
R 1435	CHIP RES.	1k	1/16W	5%	RMC1/16S 102JTH	J24189025	VER. B1	1-	B	e4
R 1435	CHIP RES.	1k	1/16W	5%	RMC1/16S 102JTH	J24189025	VER. B2	1-	B	e4
R 1435	CHIP RES.	1k	1/16W	5%	RMC1/16S 102JTH	J24189025	VER. B3	1-	B	e4
R 1435	CHIP RES.	1k	1/16W	5%	RMC1/16S 102JTH	J24189025	VER. C1	1-	B	e4
R 1435	CHIP RES.	1k	1/16W	5%	RMC1/16S 102JTH	J24189025	VER. C2	1-	B	e4
R 1435	CHIP RES.	1k	1/16W	5%	RMC1/16S 102JTH	J24189025	VER. C3	1-	B	e4
R 1435	CHIP RES.	1k	1/16W	5%	RMC1/16S 102JTH	J24189025	VER. D1	1-	B	e4
R 1435	CHIP RES.	1k	1/16W	5%	RMC1/16S 102JTH	J24189025	VER. D2	1-	B	e4
R 1435	CHIP RES.	1k	1/16W	5%	RMC1/16S 102JTH	J24189025	VER. H1	1-	B	e4
R 1435	CHIP RES.	1k	1/16W	5%	RMC1/16S 102JTH	J24189025	VER. H2	1-	B	e4
R 1436	CHIP RES.	8.2k	1/16W	5%	RMC1/16S 822JTH	J24189036		1-	B	g4
R 1437	CHIP RES.	27k	1/16W	5%	RMC1/16S 273JTH	J24189042		1-	B	f4
R 1438	CHIP RES.	220	1/16W	5%	RMC1/16S 221JTH	J24189017		1-	B	e3
R 1439	CHIP RES.	220	1/16W	5%	RMC1/16S 221JTH	J24189017		1-	B	e3
R 1440	CHIP RES.	220	1/16W	5%	RMC1/16S 221JTH	J24189017		1-	B	e4
R 1441	CHIP RES.	22k	1/16W	5%	RMC1/16S 223JTH	J24189041		1-	B	f4
R 1442	CHIP RES.	4.7k	1/16W	5%	RMC1/16S 472JTH	J24189033		1-	B	e4
R 1443	CHIP RES.	100	1/16W	5%	RMC1/16S 101JTH	J24189013		1-	A	D4
R 1444	CHIP RES.	100	1/16W	5%	RMC1/16S 101JTH	J24189013		1-	A	E4
R 1445	CHIP RES.	470	1/16W	5%	RMC1/16S 471JTH	J24189021	USA A2	1-	A	D4
R 1445	CHIP RES.	470	1/16W	5%	RMC1/16S 471JTH	J24189021	VER. A1	1-	A	D4
R 1445	CHIP RES.	470	1/16W	5%	RMC1/16S 471JTH	J24189021	VER. A2	1-	A	D4
R 1445	CHIP RES.	470	1/16W	5%	RMC1/16S 471JTH	J24189021	VER. A3	1-	A	D4
R 1445	CHIP RES.	470	1/16W	5%	RMC1/16S 471JTH	J24189021	VER. B1	1-	A	D4
R 1445	CHIP RES.	470	1/16W	5%	RMC1/16S 471JTH	J24189021	VER. B2	1-	A	D4
R 1445	CHIP RES.	470	1/16W	5%	RMC1/16S 471JTH	J24189021	VER. B3	1-	A	D4
R 1445	CHIP RES.	470	1/16W	5%	RMC1/16S 471JTH	J24189021	VER. C1	1-	A	D4
R 1445	CHIP RES.	470	1/16W	5%	RMC1/16S 471JTH	J24189021	VER. C2	1-	A	D4
R 1445	CHIP RES.	470	1/16W	5%	RMC1/16S 471JTH	J24189021	VER. C3	1-	A	D4
R 1445	CHIP RES.	470	1/16W	5%	RMC1/16S 471JTH	J24189021	VER. D1	1-	A	D4
R 1445	CHIP RES.	470	1/16W	5%	RMC1/16S 471JTH	J24189021	VER. D2	1-	A	D4
R 1445	CHIP RES.	470	1/16W	5%	RMC1/16S 471JTH	J24189021	VER. H1	1-	A	D4
R 1445	CHIP RES.	470	1/16W	5%	RMC1/16S 471JTH	J24189021	VER. H2	1-	A	D4
R 1446	CHIP RES.	100	1/16W	5%	RMC1/16S 101JTH	J24189013		1-	A	D3
R 1447	CHIP RES.	100	1/16W	5%	RMC1/16S 101JTH	J24189013		1-	A	D3
R 1448	CHIP RES.	100	1/16W	5%	RMC1/16S 101JTH	J24189013		1-	A	D3
R 1449	CHIP RES.	1k	1/16W	5%	RMC1/16S 102JTH	J24189025		1-	A	D3
R 1450	CHIP RES.	1k	1/16W	5%	RMC1/16S 102JTH	J24189025		1-	A	D3
R 1451	CHIP RES.	82	1/16W	5%	RMC1/16S 820JTH	J24189012		1-	B	e3
R 1452	CHIP RES.	82	1/16W	5%	RMC1/16S 820JTH	J24189012		1-	B	e3
R 1453	CHIP RES.	1k	1/16W	5%	RMC1/16S 102JTH	J24189025		1-	A	E4
R 1454	CHIP RES.	100	1/16W	5%	RMC1/16S 101JTH	J24189013		1-	A	E4
R 1455	CHIP RES.	47	1/16W	5%	RMC1/16S 470JTH	J24189009		1-	B	f3
R 1456	CHIP RES.	12k	1/16W	5%	RMC1/16S 123JTH	J24189038		1-	B	e4
R 1457	CHIP RES.	47	1/16W	5%	RMC1/16S 470JTH	J24189009		1-	B	f2
R 1459	CHIP RES.	820	1/2W	5%	RK73K2HTE820-J	J24279028		1-	B	f2
R 1460	CHIP RES.	820	1/2W	5%	RK73K2HTE820-J	J24279028		1-	B	f2
R 1461	CHIP RES.	47	1/16W	5%	RMC1/16S 470JTH	J24189009		1-	A	C2
R 1462	CHIP RES.	47	1/16W	5%	RMC1/16S 470JTH	J24189009		1-	B	f2
R 1463	CHIP RES.	470	1/2W	5%	RMC1/2 471JCTP	J24275471		1-	B	f2
R 1464	CHIP RES.	22k	1/16W	5%	RMC1/16S 223JTH	J24189041		1-	B	f2
R 1465	CHIP RES.	8.2k	1/16W	5%	RMC1/16S 822JTH	J24189036		1-	B	g3
R 1466	CHIP RES.	82	1/16W	5%	RMC1/16S 820JTH	J24189012		1-	B	f2

MAIN Unit

Parts List

REF	DESCRIPTION	VALUE	V/W	TOL.	MFR'S DESIG	VXSTD P/N	VERS.	LOT	SIDE	LAY ADR
R 1488	CHIP RES.	10k	1/16W	5%	RMC1/16S 10856 0.0m527.505 35.16	□S/GS4005 35.16	□S/GS4005 35.16	□S/GS4005	35D5 447.0	10856 0.0m

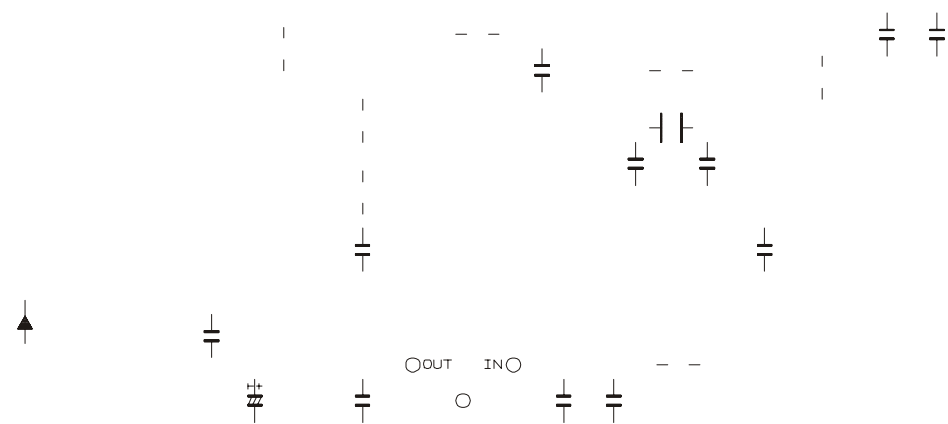
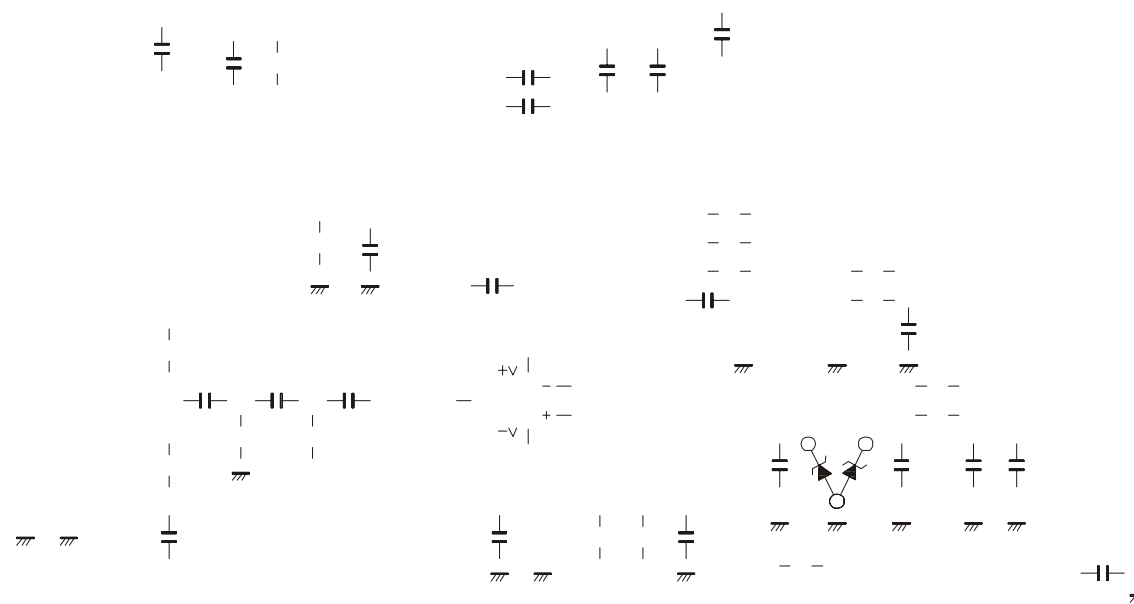
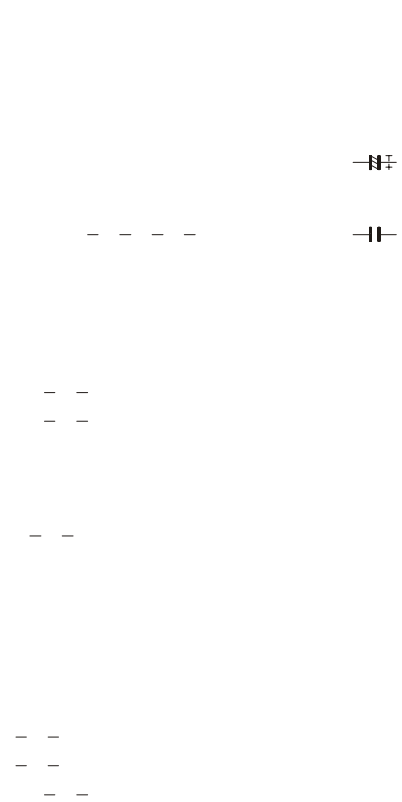
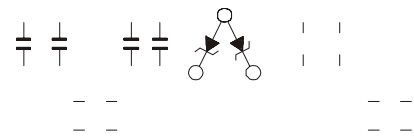

PANEL Unit

Parts List

REF	DESCRIPTION	VALUE	V/W	TOL.	MFR'S DESIG	VXSTD P/N	VERS.	LOT	SIDE	LAY ADR
PCB with Components						CB2349001	USA			
						CB2349003	EXP			
						CB2349004	AUS			
Printed Circuit Board					AH016M000	FR0111800		1-		
C 2001	CHIP CAP.	47pF	50V	CH	GRM36CH470J50PT	K22178228		1-	B	a1
C 2002	CHIP CAP.	47pF	50V	CH	GRM36CH470J50PT	K22178228		1-	B	a1
C 2003	CHIP CAP.	47pF	50V	CH	GRM36CH470J50PT	K22178228		1-	B	a1
C 2004	CHIP CAP.	47pF	50V	CH	GRM36CH470J50PT	K22178228		1-	B	a1
C 2005	CHIP CAP.	0.015uF	16V	B	GRM36B153K16PT	K22128807		1-	B	b1
C 2006	CHIP CAP.	0.015uF	16V	B	GRM36B153K16PT	K22128807		1-	B	a1
C 2007	CHIP CAP.	0.01uF	16V	B	GRM36B103K16PT	K22128804		1-	B	h3
C 2008	CHIP CAP.	0.01uF	16V	B	GRM36B103K16PT	K22128804		1-	B	h2
C 2010	CHIP CAP.	0.01uF	16V	B	GRM36B103K16PT	K22128804		1-	B	h1
C 2011	CHIP CAP.	0.01uF	16V	B	GRM36B103K16PT	K22128804		1-	B	h1
C 2013	CHIP TA.CAP.	10uF	6.3V		TEMSVA0J106M-8R	K78080027		1-	B	e1
C 2014	CHIP CAP.	0.01uF	16V	B	GRM36B103K16PT	K22128804		1-	B	e2
C 2015	CHIP CAP.	0.001uF	50V	B	GRM36B102K50PT	K22178809		1-	B	a2
C 2016	CHIP TA.CAP.	10uF	6.3V		TEMSVA0J106M-8R	K78080027		1-	B	d2
C 2017	CHIP CAP.	0.001uF	50V	B	GRM36B102K50PT	K22178809		1-	B	d2
C 2018	CHIP CAP.	1uF	10V	F	GRM39F105Z10PT	K22105001		1-	B	c2
C 2019	CHIP CAP.	0.001uF	50V	B	GRM36B102K50PT	K22178809		1-	B	c2
C 2020	CHIP CAP.	0.1uF	10V	B	GRM36B104K10PT	K22108802		1-	B	g2
C 2021	CHIP CAP.	0.001uF	50V	B	GRM36B102K50PT	K22178809		1-	B	g2
C 2022	CHIP CAP.	39pF	50V	CH	GRM36CH390J50PT	K22178226		1-	B	f2
C 2023	CHIP CAP.	39pF	50V	CH	GRM36CH390J50PT	K22178226		1-	B	f2
C 2024	CHIP CAP.	0.001uF	50V	B	GRM36B102K50PT	K22178809		1-	B	c2
C 2025	CHIP CAP.	0.1uF	10V	B	GRM36B104K10PT	K22108802		1-	B	c2
C 2026	CHIP CAP.	0.001uF	50V	B	GRM36B102K50PT	K22178809		1-	B	c2
C 2027	CHIP CAP.	0.001uF	50V	B	GRM36B102K50PT	K22178809		1-	B	d2
C 2028	CHIP CAP.	680pF	50V	B	GRM36B681K50PT	K22178807		1-	B	d2
C 2029	CHIP CAP.	100pF	50V	CH	GRM36CH101J50PT	K22178236		1-	B	d2
C 2030	CHIP CAP.	100pF	50V	CH	GRM36CH101J50PT	K22178236		1-	B	d2
C 2031	CHIP CAP.	0.01uF	16V	B	GRM36B103K16PT	K22128804		1-	B	e2
C 2032	CHIP CAP.	0.001uF	50V	B	GRM36B102K50PT	K22178809		1-	B	e2
C 2033	CHIP CAP.	0.01uF	16V	B	GRM36B103K16PT	K22128804		1-	B	d2
C 2034	CHIP CAP.	100pF	50V	CH	GRM36CH101J50PT	K22178236		1-	B	d2
C 2035	CHIP CAP.	0.001uF	50V	B	GRM36B102K50PT	K22178809		1-	B	a2
C 2036	CHIP CAP.	0.001uF	50V	B	GRM36B102K50PT	K22178809		1-	B	b2
C 2037	CHIP CAP.	470pF	50V	B	GRM36B471K50PT	K22178805		1-	B	b2
C 2038	CHIP CAP.	0.022uF	16V	B	GRM36B223K16PT	K22128806		1-	B	b2
C 2039	CHIP CAP.	0.022uF	16V	B	GRM36B223K16PT	K22128806		1-	B	b2
C 2040	CHIP CAP.	0.01uF	16V	B	GRM36B103K16PT	K22128804		1-	B	b2
C 2041	CHIP CAP.	15pF	50V	CH	GRM36CH150J50PT	K22178216		1-	B	b3
C 2042	CHIP CAP.	1uF	10V	F	GRM39F105Z10PT	K22105001		1-	B	b2
C 2043	CHIP CAP.	0.001uF	50V	B	GRM36B102K50PT	K22178809		1-	B	b2
C 2044	CHIP CAP.	0.0056uF	25V	B	GRM36B562K50PT	K22148802		1-	B	b3
C 2047	CHIP CAP.	0.001uF	50V	B	GRM36B102K50PT	K22178809		1-	B	g2
C 2050	CHIP CAP.	0.001uF	50V	B	GRM36B102K50PT	K22178809		1-	B	g1
C 2051	CHIP CAP.	0.001uF	50V	B	GRM36B102K50PT	K22178809		1-	B	g1
C 2052	CHIP CAP.	0.001uF	50V	B	GRM36B102K50PT	K22178809		1-	B	e3
D 2001	LED				SPMA10-1104Q7NC	G2070878		1-	A	G1
D 2002	LED				SPMA10-1104Q7NC	G2070878		1-	A	G2
D 2003	LED				19-215UYOC/S530-A2/TR8	G2070884		1-	A	G1
D 2004	LED				19-215UYOC/S530-A2/TR8	G2070884		1-	A	B1
D 2005	LED				19-215UYOC/S530-A2/TR8	G2070884		1-	A	E2
D 2006	LED				19-215UYOC/S530-A2/TR8	G2070884		1-	A	D2
D 2007	LED				19-215UYOC/S530-A2/TR8	G2070884		1-	A	G2
D 2008	LED				19-215UYOC/S530-A2/TR8	G2070884		1-	A	C2
D 2009	LED				19-215UYOC/S530-A2/TR8	G2070884		1-	A	G2
D 2010	LED				19-215UYOC/S530-A2/TR8	G2070884		1-	A	B2
D 2011	DIODE				HZM27WA-TR	G2070530		1-	B	f3
D 2012	DIODE				UDZS TE-17 6.8B	G2070888		1-	B	a1
D 2013	DIODE				UDZS TE-17 6.8B	G2070888		1-	B	g1
D 2014	DIODE				HZM27WA-TR	G2070530		1-	B	b1
D 2015	LED				19-215UYOC/S530-A2/TR8	G2070884		1-	A	F2
D 2016	LED				19-215UYOC/S530-A2/TR8	G2070884		1-	A	D2
DS2001	LCD				070520	G6090155		1-	A	E1
L 2001	M.RFC	1uH			LK1608 1R0K-T	L1690687		1-	B	e2
L 2002	M.RFC	2.2uH			LK1608 2R2K-T	L1690634		1-	B	b2
P 2000	WIRE ASSY				AH016M	T9207057		1-		
Q 2001	IC				M38223M4M-366HP	G1093984		1-	B	f2
Q 2002	IC				LC75821E	G1092191		1-	B	d2
Q 2003	IC				NJM78L05UA TE1	G1091325		1-	B	c2

PANEL Unit

Parts List

REF	DESCRIPTION	VALUE	V/W	TOL.	MFR'S DESIG	VXSTD P/N	VERS.	LOT	SIDE	LAY ADR
Q 2004	TRANSISTOR				2SA1774 TL R	G3117748R		1-	B	g2
Q 2005	TRANSISTOR				DTC144EE TL	G3070075		1-	B	g2
Q 2006	TRANSISTOR				2SB1132 T100 Q	G3211327Q		1-	B	b2
Q 2007	TRANSISTOR				UMW1 TR	G3070078		1-	B	c2
Q 2011	IC				NJM2904V-TE1	G1091677		1-	B	b2
R 2001	CHIP RES.	1k	1/16W	5%	RMC1/16S 102JTH	J24189025		1-	B	a1
R 2002	CHIP RES.	1k	1/16W	5%	RMC1/16S 102JTH	J24189025		1-	B	a1
R 2003	CHIP RES.	100k	1/16W	5%	RMC1/16S 104JTH	J24189049		1-	B	a1
R 2004	CHIP RES.	100k	1/16W	5%	RMC1/16S 104JTH	J24189049		1-	B	a1
R 2005	CHIP RES.	1k	1/16W	5%	RMC1/16S 102JTH	J24189025		1-	B	f2
R 2006	CHIP RES.	1k	1/16W	5%	RMC1/16S 102JTH	J24189025		1-	B	f2
R 2007	CHIP RES.	100k	1/16W	5%	RMC1/16S 104JTH	J24189049		1-	B	a1
R 2008	CHIP RES.	100k	1/16W	5%	RMC1/16S 104JTH	J24189049		1-	B	b2
R 2009	CHIP RES.	10k	1/16W	5%	RMC1/16S 103JTH	J24189037		1-	B	a1
R 2011	CHIP RES.	10	1/16W	5%	RMC1/16S 100JTH	J24189001		1-	B	g1
R 2012	CHIP RES.	10	1/16W	5%	RMC1/16S 100JTH	J24189001		1-	B	g2
R 2013	CHIP RES.	2.2k	1/16W	5%	RMC1/16S 222JTH	J24189029		1-	B	h1
R 2014	CHIP RES.	1k	1/16W	5%	RMC1/16S 102JTH	J24189025		1-	B	e2
R 2015	CHIP RES.	1k	1/16W	5%	RMC1/16S 102JTH	J24189025		1-	B	e2
R 2016	CHIP RES.	1k	1/16W	5%	RMC1/16S 102JTH	J24189025		1-	B	e2
R 2017	CHIP RES.	1k	1/16W	5%	RMC1/16S 102JTH	J24189025		1-	B	e2
R 2018	CHIP RES.	1k	1/16W	5%	RMC1/16S 102JTH	J24189025		1-	B	e2
R 2019	CHIP RES.	1k	1/16W	5%	RMC1/16S 102JTH	J24189025		1-	B	e2
R 2020	CHIP RES.	1k	1/16W	5%	RMC1/16S 102JTH	J24189025		1-	B	f2
R 2021	CHIP RES.	1k	1/16W	5%	RMC1/16S 102JTH	J24189025		1-	B	f2
R 2022	CHIP RES.	1k	1/16W	5%	RMC1/16S 102JTH	J24189025		1-	B	f2
R 2023	CHIP RES.	1k	1/16W	5%	RMC1/16S 102JTH	J24189025		1-	B	e2
R 2025	CHIP RES.	1k	1/16W	5%	RMC1/16S 102JTH	J24189025		1-	B	e2
R 2026	CHIP RES.	1k	1/16W	5%	RMC1/16S 102JTH	J24189025		1-	B	e2
R 2027	CHIP RES.	1k	1/16W	5%	RMC1/16S 102JTH	J24189025		1-	B	f2
R 2028	CHIP RES.	1k	1/16W	5%	RMC1/16S 102JTH	J24189025		1-	B	f2
R 2029	CHIP RES.	220k	1/16W	5%	RMC1/16S 224JTH	J24189053		1-	B	e2
R 2030	CHIP RES.	33k	1/16W	5%	RMC1/16S 333JTH	J24189043		1-	B	e2
R 2031	CHIP RES.	100k	1/16W	5%	RMC1/16S 104JTH	J24189049		1-	B	e2
R 2032	CHIP RES.	220k	1/16W	5%	RMC1/16S 224JTH	J24189053		1-	B	d2
R 2033	CHIP RES.	33k	1/16W	5%	RMC1/16S 333JTH	J24189043		1-	B	d2
R 2034	CHIP RES.	100k	1/16W	5%	RMC1/16S 104JTH	J24189049		1-	B	e2
R 2035	CHIP RES.	68k	1/16W	5%	RMC1/16S 683JTH	J24189047		1-	B	e2
R 2036	CHIP RES.	68k	1/16W	5%	RMC1/16S 683JTH	J24189047		1-	B	f2
R 2037	CHIP RES.	68k	1/16W	5%	RMC1/16S 683JTH	J24189047		1-	B	f2
R 2038	CHIP RES.	68k	1/16W	5%	RMC1/16S 683JTH	J24189047		1-	B	a2
R 2039	CHIP RES.	1k	1/16W	5%	RMC1/16S 102JTH	J24189025		1-	B	f2
R 2040	CHIP RES.	1k	1/16W	5%	RMC1/16S 102JTH	J24189025		1-	B	f2
R 2041	CHIP RES.	1k	1/16W	5%	RMC1/16S 102JTH	J24189025		1-	B	f2
R 2042	CHIP RES.	1k	1/16W	5%	RMC1/16S 102JTH	J24189025		1-	B	f2
R 2043	CHIP RES.	1k	1/16W	5%	RMC1/16S 102JTH	J24189025		1-	B	g2
R 2044	CHIP RES.	1k	1/16W	5%	RMC1/16S 102JTH	J24189025		1-	B	f2
R 2045	CHIP RES.	1k	1/16W	5%	RMC1/16S 102JTH	J24189025		1-	B	g2
R 2046	CHIP RES.	470	1/16W	5%	RMC1/16S 471JTH	J24189021		1-	B	f2
R 2047	CHIP RES.	1k	1/16W	5%	RMC1/16S 102JTH	J24189025		1-	B	f1
R 2048	CHIP RES.	1k	1/16W	5%	RMC1/16S 102JTH	J24189025		1-	B	f1
R 2049	CHIP RES.	1k	1/16W	5%	RMC1/16S 102JTH	J24189025		1-	B	f1
R 2050	CHIP RES.	1k	1/16W	5%	RMC1/16S 102JTH	J24189025		1-	B	f1
R 2051	CHIP RES.	10k	1/16W	0.5%	RR0510P-103-D	J24189143		1-	B	f1
R 2052	CHIP RES.	20k	1/16W	0.5%	RR0510R-203-D	J24189150		1-	B	f1
R 2053	CHIP RES.	39k	1/16W	0.5%	RR0510R-393-D	J24189157		1-	B	f1
R 2054	CHIP RES.	82k	1/16W	0.5%	RR0510R-823-D	J24189165		1-	B	f1
R 2055	CHIP RES.	150k	1/16W	5%	RMC1/16S 154JTH	J24189051		1-	B	f1
R 2056	CHIP RES.	100k	1/16W	5%	RMC1/16S 104JTH	J24189049		1-	B	g2
R 2057	CHIP RES.	47k	1/16W	5%	RMC1/16S 473JTH	J24189045		1-	B	g2
R 2058	CHIP RES.	47k	1/16W	5%	RMC1/16S 473JTH	J24189045		1-	B	g2
R 2059	CHIP RES.	1M	1/16W	5%	RMC1/16S 105JTH	J24189061		1-	B	f2
R 2060	CHIP RES.	10	1/10W	5%	RMC1/10T 100J	J24205100		1-	B	c3
R 2061	CHIP RES.	10	1/10W	5%	RMC1/10T 100J	J24205100		1-	B	b2
R 2062	CHIP RES.	2.2k	1/16W	5%	RMC1/16S 222JTH	J24189029		1-	B	c2
R 2063	CHIP RES.	2.2k	1/16W	5%	RMC1/16S 222JTH	J24189029		1-	B	c2
R 2064	CHIP RES.	22k	1/16W	5%	RMC1/16S 223JTH	J24189041		1-	B	c2
R 2065	CHIP RES.	22k	1/16W	5%	RMC1/16S 223JTH	J24189041		1-	B	c2
R 2066	CHIP RES.	390	1/16W	5%	RMC1/16S 391JTH	J24189020		1-	B	b2
R 2067	CHIP RES.	270	1/16W	5%	RMC1/16S 271JTH	J24189018		1-	B	c2
R 2068	CHIP RES.	330	1/16W	5%	RMC1/16S 331JTH	J24189019		1-	B	d2
R 2069	CHIP RES.	220	1/16W	5%	RMC1/16S 221JTH	J24189017		1-	B	b2
R 2070	CHIP RES.	82	1/16W	5%	RMC1/16S 820JTH	J24189012		1-	B	b2

PANEL Unit

Parts List

REF	DESCRIPTION	VALUE	V/W	TOL.	MFR'S DESIG	VXSTD P/N	VERS.	LOT	SIDE	LAY ADR
R 2071	CHIP RES.	82	1/16W	5%	RMC1/16S 820JTH	J24189012		1-	B	b1
R 2072	CHIP RES.	56k	1/16W	5%	RMC1/16S 563JTH	J24189046		1-	B	d2
R 2073	CHIP RES.	820	1/16W	5%	RMC1/16S 821JTH	J24189024		1-	B	e2
R 2074	CHIP RES.	47	1/16W	5%	RMC1/16S 470JTH	J24189009		1-	B	e2
R 2075	CHIP RES.	100k	1/16W	5%	RMC1/16S 104JTH	J24189049		1-	B	d2
R 2077	CHIP RES.	4.7k	1/16W	5%	RMC1/16S 472JTH	J24189033		1-	B	b2
R 2078	CHIP RES.	2.2M	1/16W	5%	RMC1/16S 225JTH	J24189065		1-	B	b2
R 2079	CHIP RES.	100k	1/16W	5%	RMC1/16S 104JTH	J24189049		1-	B	b2
R 2080	CHIP RES.	15k	1/16W	5%	RMC1/16S 153JTH	J24189039		1-	B	b2
R 2081	CHIP RES.	10k	1/16W	5%	RMC1/16S 103JTH	J24189037		1-	B	b2
R 2082	CHIP RES.	1k	1/16W	5%	RMC1/16S 102JTH	J24189025		1-	B	b2
R 2083	CHIP RES.	4.7k	1/16W	5%	RMC1/16S 472JTH	J24189033		1-	B	b2
R 2084	CHIP RES.	100k	1/16W	5%	RMC1/16S 104JTH	J24189049	AUS	1-	B	b2
R 2084	CHIP RES.	100k	1/16W	5%	RMC1/16S 104JTH	J24189049	EXP	1-	B	b2
R 2084	CHIP RES.	100k	1/16W	5%	RMC1/16S 104JTH	J24189049	USA	1-	B	b2
R 2085	CHIP RES.	100k	1/16W	5%	RMC1/16S 104JTH	J24189049		1-	B	b2
R 2086	CHIP RES.	33k	1/16W	5%	RMC1/16S 333JTH	J24189043		1-	B	b2
R 2087	CHIP RES.	47k	1/16W	5%	RMC1/16S 473JTH	J24189045		1-	B	b2
R 2088	CHIP RES.	100	1/16W	5%	RMC1/16S 101JTH	J24189013		1-	B	a2
R 2089	CHIP RES.	10k	1/16W	5%	RMC1/16S 103JTH	J24189037		1-	B	b3
R 2090	CHIP RES.	100k	1/16W	5%	RMC1/16S 104JTH	J24189049		1-	B	f2
R 2091	CHIP RES.	100k	1/16W	5%	RMC1/16S 104JTH	J24189049		1-	B	f2
R 2092	CHIP RES.	100k	1/16W	5%	RMC1/16S 104JTH	J24189049		1-	B	f2
R 2093	CHIP RES.	1k	1/16W	5%	RMC1/16S 102JTH	J24189025		1-	A	B2
R 2094	CHIP RES.	0	1/16W	5%	RMC1/16S JPTH	J24189070		1-	A	B2
R 2095	CHIP RES.	1k	1/16W	5%	RMC1/16S 102JTH	J24189025		1-	A	B2
R 2096	CHIP RES.	1k	1/16W	5%	RMC1/16S 102JTH	J24189025		1-	A	B2
R 2097	CHIP RES.	22	1/16W	5%	RMC1/16S 220JTH	J24189005		1-	B	e3
R 2098	CHIP RES.	22	1/16W	5%	RMC1/16S 220JTH	J24189005		1-	B	e2
R 2099	CHIP RES.	390	1/16W	5%	RMC1/16S 391JTH	J24189020		1-	B	c2
R 2100	CHIP RES.	0	1/16W	5%	RMC1/16 000JATP	J24185000		1-	B	g1
R 2101	CHIP RES.	0	1/16W	5%	RMC1/16 000JATP	J24185000		1-	A	B2
R 2102	CHIP RES.	10k	1/16W	5%	RMC1/16S 103JTH	J24189037		1-	B	a2
R 2103	CHIP RES.	0	1/16W	5%	RMC1/16S JPTH	J24189070		1-	B	a1
S 2014	TACT SWITCH				SKQMAL	N5090105		1-	A	H1
VR2001	POT.				RK09D1130C2P 10KB	J60800268		1-	A	A1
VR2002	POT.				RK09D1130C2P 10KB	J60800268		1-	A	A2
X 2001	XTAL CSA-310	3.6864MHz			3.6864MHZ	H0102988		1-	B	f2
	LCD HOLDER				(LCD)	RA0540800		1-		
	INTER CONNECTOR					RA0540900		1-		
	LIGHT GUIDE					RA0540700		1-		
	DIFFUSER SHEET					RA0551800		1-		
	REFLECTOR SHEET					RA0551900		1-		
	LCD SPACER					RA0552200		1-		

PANEL Unit

Note

C

Circuit Diagram

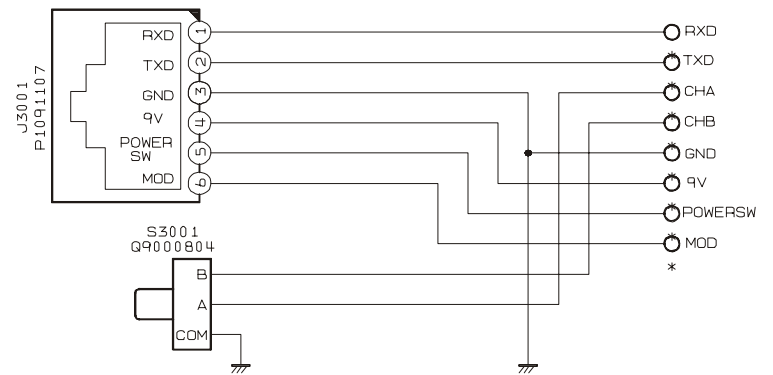

Parts Layout

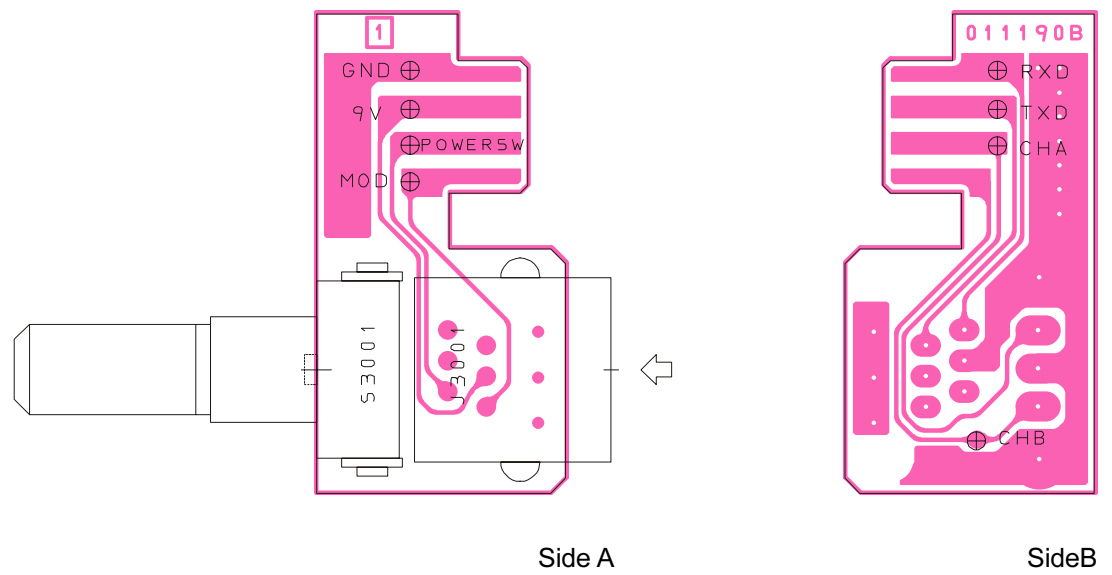

Parts List

REF	DESCRIPTION	VALUE	V/W	TOL.	MFR'S DESIG	VXSTD P/N	VERS.	LOT	SIDE	LAY ADR
	PCB with Components					CB2350001				
	Printed Circuit Board				AH016M000	FR0111900		1-		
J 3001	CONNECTOR				NTC-623PCBL6-B	P1091107		1-		
S 3001	ROTARY ENCODER				EC11B15202AA	Q9000804		1-		

C

Note



Copyright 2003
VERTEX STANDARD CO., LTD.
All rights reserved.

No portion of this manual
may be reproduced
without the permission of
VERTEX STANDARD CO., LTD.