

SUPER-PRO COMMUNICATIONS RECEIVER

TECHNICAL DESCRIPTION



OPERATING INSTRUCTIONS

**A PRODUCT
OF**

HAMMARLUND MANUFACTURING CO., INC.
460 West 34th Street : : New York 1, N. Y.

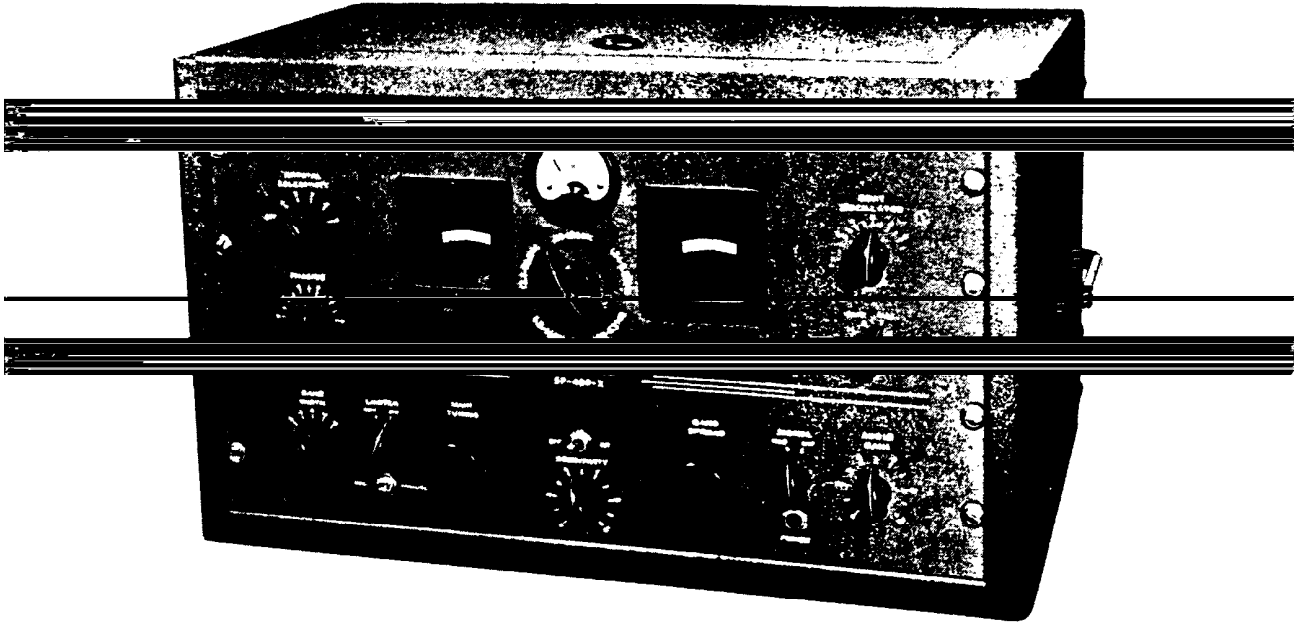

FIG. 1—Front view of "Super-Pro" model SP-400-X.

SECTION I—DESCRIPTION

I. GENERAL

a. *Features*—The Series 400-X is a superheterodyne receiver for amplitude-modulated (AM) or continuous-wave (CW) code signals within the range of .540 to 30. megacycles, or 555 to 10 meters. This coverage is obtained in five switch-selected bands, the three highest of

the bands are "band out" controlled by a hand-operated control knob. An extremely wide range of selectivity is provided by a

selectivity crystal filter and variable-selectivity I-F transformers. Either manual or automatic sensitivity control can be selected by flipping a switch, and a noise-limiter circuit is also provided.

b. *Mechanical*—For general use, cabinets are furnished for both Receiver and Power Supply. When furnished as Rack Models, both Receiver and Power Supply have front-panel notches to fit standard relay racks, dust covers fastened by knurled thumb nuts to front panel and bottom plates for protection against dust and damage. An interconnecting power cable is furnished with the equipment.

2. POWER SOURCES

- a. *A-C Operation . . .*
 - 105-125 Volts, 50-60 cps
 - 180 watts average power consumption
- b. *Battery Operation . . .*
 - 6-volt storage battery, drain
 - 6.25 amperes for heaters.
 - Five 45-volt "B" batteries, drain
 - 117 milliamperes at 225 volts;
 - 4.5 milliamperes at 90 volts.
 - One 45-volt "C" battery, drain
 - 10 milliamperes.

3. WEIGHTS AND DIMENSIONS

- a. *Table Mounting:*
 - Receiver . . .
 - Cabinet Dimensions: $12\frac{1}{4}$ " high, $21\frac{1}{2}$ " wide,
 $15\frac{1}{4}$ " deep.
 - Weight, in cabinet: 67 pounds.
 - Power Supply . . .
 - Cabinet Dimensions: $7\frac{5}{8}$ " high, $13\frac{5}{8}$ " wide,
 $8\frac{5}{16}$ " deep.
 - Weight, in cabinet: 28 pounds.
 - Loudspeaker . . .
 - Cabinet Dimensions: $12\frac{1}{4}$ " high, $12\frac{1}{2}$ " wide,
 $7\frac{1}{4}$ " deep.
 - Weight, in cabinet: 11 pounds.
- b. *Rack Mounting:*
 - Receiver . . .
 - Dust Cover Dimensions: 10" high, 17" wide,
 $14\frac{5}{8}$ " deep.
 - Panel Dimensions: $10\frac{15}{32}$ " high, 19" wide,
 - Weight complete: 49 pounds.
 - Power Supply . . .
 - Dust Cover Dimensions: $7\frac{5}{8}$ " high, $13\frac{5}{8}$ " wide,
 $8\frac{5}{16}$ " deep.
 - Panel Dimensions: $8\frac{23}{32}$ " high, 19" wide
 - Weight, complete: 33 pounds.
 - Loudspeaker . . .
 - Weight: 4 pounds.

4. FREQUENCY BANDS

- a. *List of Bands*—Five frequency bands are marked on the front

panel (FIG. 2). Select the desired band by turning the BAND SWITCH knob right or left to the band indicated.

These bands are:

- 540 to 1240 kilocycles
- 1.24 to 2.86 megacycles
- 2.85 to 6.3 megacycles
- 6.3 to 14.0 megacycles
- 13.4 to 30.0 megacycles

b. *Band Identification*—Besides the markings on the front panel, a mask with windows shows a calibrated scale on the MAIN TUNING dial to correspond with the band selected by the band switch. This operation is automatic. When the band switch is turned, the

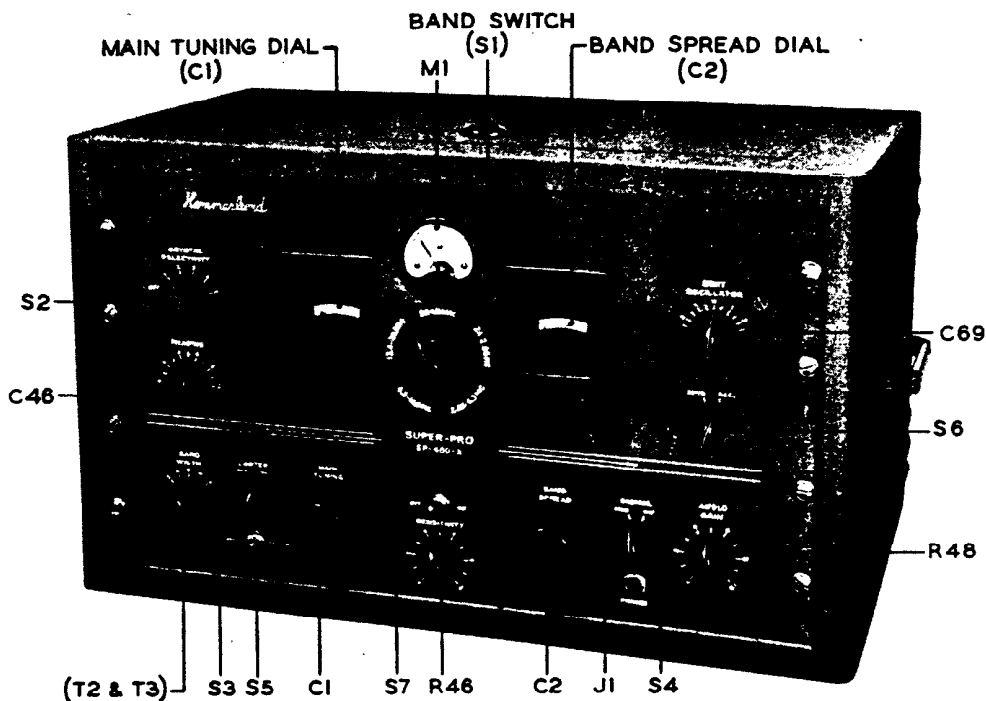

FIG. 2—Lay-out of controls referred to in text.

mask on the MAIN TUNING dial turns with it—they are geared together.

c. *Band Spread*—A separate BAND SPREAD control provides simplified tuning over a narrow frequency range. The BAND SPREAD dial has a scale reading from 0-100 through about 170 degrees. Starting from 100, the frequency covered by moving this dial will extend from that shown by the setting of the MAIN TUNING dial to some lower frequency, since the capacitance of the band-spread capacitor (C2) increases as the scale approaches 0 (zero). To cover a specific range with the BAND SPREAD dial, first set the MAIN

TUNING dial at the high-frequency end of the band, which is to be spread.

d. *Dial Calibration*—The MAIN TUNING dial is directly calibrated as follows and these calibrations hold true only when the BAND SPREAD dial is set at 100:

BAND	CALIBRATION
540 kc.—1240 kc.	10 kc. per division
1.24 mc.—2.86 mc.	20 kc. per division
2.85 mc.—6.3 mc.	50 kc. per division
6.3 mc.—14.0 mc.	100 kc. per division
13.4 mc.—30.0 mc.	200 kc. per division

5. POWER OUTPUT

The Receiver is designed to operate at approximately 2 watts. The

output and is, of course, less at lower levels. The Receiver has two output circuits with marked terminals along the rear of the chassis (FIG. 3).

b. *500 Ohm Terminals*—These are for use where large amounts of power are needed, such as for loudspeaker (See PAR. 7f), recorder or for a 500-ohm transmission line. All power output measurements and all audio-frequency fidelity readings are to be taken at these terminals.

c. *PHONES Terminals*—These are connected in parallel with the phone jack on the front panel, and provide reduced power for ear-phones (see PAR. 20b).

SECTION II—INSTALLATION AND OPERATION

6. INITIAL PROCEDURE

Precaution—UNPACK THE EQUIPMENT CAREFULLY. CHECK IT THOROUGHLY TO DETERMINE WHETHER IT HAS BEEN DAMAGED DURING SHIPMENT. If any of the equipment has been received in damaged condition immediately notify the carrier who delivered it. File a claim for damages with the carrier, because any damages incurred in transit are the responsibility of the carrier.

7. INSTALLATION

a. *Connection to Power Supply*—Connect Receiver to Power Supply as follows:

(1) Remove the sheet-metal covers from terminal strip (E4, FIG. 3) on rear of Receiver and from terminal strip (E1, FIG. 3) on Power Supply. See that all ten screws on each strip are unscrewed at least three turns. Then attach one end of the connector cable to each terminal strip *exactly* as shown in FIG. 3 and tighten all screws securely. Make certain that each slotted spade lug on the cable strips makes contact with its respective screw terminal *only*, since a lug jammed between *two* screws could cause considerable trouble. Immediately

replace both metal covers and do not remove them while the Power Supply is connected to the a-c power line.

(2) The spacing of spade lugs on cable terminal strips is exactly the same as the spacing of screws on Receiver and Power Supply. If the two fail to go together easily, DON'T USE FORCE. Be sure all screws are unscrewed far enough. If a spade lug has been bent or pushed out of place by rough handling, straighten it and try again. Spade lugs should slip under screws from the top.

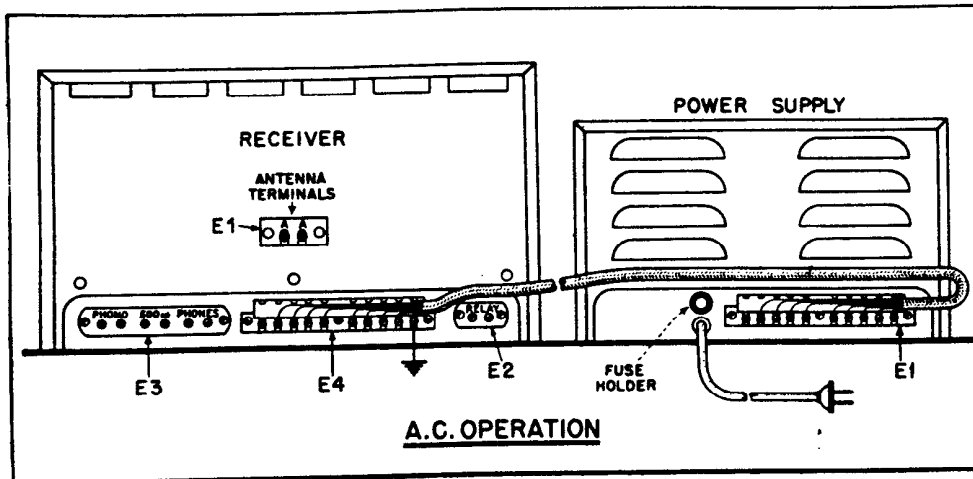

FIG. 3—Connectors for power cable—A.C. operation.

b. *Connection for Battery Operation*—A cable for use in battery operation is available on special order. This cable (W2 in Parts List) is made up of eight loose wires. The other end of the cable is made up

color code for the eight loose wires), or make up connections to serve the purpose. The Receiver is designed to be used with a battery. To place the terminal cover *before* making connections to the batteries. When disconnecting battery operation, disconnect the battery cable. All connections of the Receiver are the same with either the Power Supply.

c. *Antenna*—The choice of an antenna is usually governed by the space available for installing it and the type of service (frequency bands, directivity, etc.), in which the Receiver is to be used. While the high sensitivity of the "Super-Pro" makes the antenna problem

antenna system. The following comments are offered as a guide to some basic antenna design considerations. Detailed information on antennas has been widely published and should be consulted for answers to special problems.

(1) *Wide-Band Antenna*: For general use over a wide range of frequencies such as is covered by the Super-Pro, the antenna may

consist of a horizontal wire 50 to 75 feet long suspended between insulators and located *in the clear* and as far off the ground as practicable. Avoid running the antenna close to and especially *parallel* to an electric power line. If the antenna *must* run near a power line, run the antenna at *right angles* to the line.

Connect a single-wire lead-in to the end of the antenna nearest the Receiver and try to have the lead-in wire leave the antenna approximately at right angles. Connect the lead-in to one of the "A" terminals (on terminal strip E1, FIG. 3) at the rear of the Receiver. Connect the other "A" terminal to a good ground, preferably not to the Receiver chassis. Run this ground lead to a water pipe or to a metal rod driven into the ground deep enough to reach moist earth. Keep

sible electrical connections between the antenna and its lead-in and between the ground lead and "ground."

(2) *Narrow-Band Antenna:* For high receiving efficiency over a narrow band of high frequencies, a tuned antenna connected to the Receiver through a balanced lead-in is desirable. The tuned antenna may be a doublet consisting of two lengths of horizontal wire each approximately one-fourth the wavelength at the middle of the desired band and connected by an insulator. The balanced lead-in may be a twisted pair of well insulated wires each connected to one of the halves of the doublet either side of the center insulator. For the Super-Pro this lead-in should have approximately 100 ohms impedance. At the Receiver, connect each wire of the twisted pair to one of the "A" terminals. Do not ground *either* "A" terminal. Doublets are "directive" in that they receive best those signals which come from a point at right angles to their length. Remember that tuned antennas, while excellent for the particular narrow band they were designed to cover, may be very much *less* efficient than the long simple antenna described above when signals are sought in some *other* band.

d. *Chassis Ground:* It is not usually necessary to ground the Receiver chassis, but this can be done by connecting the ground lead to the left-hand PHONO or to the left-hand PHONES terminal (located on terminal strip E3, FIG. 3). These two terminals are grounded to the inside of the chassis.

e. *Earphones:* Plug a headset into the PHONES jack (J1, FIG. 2), or connect it to screw terminals marked PHONES on rear of chassis. No matching transformer is necessary (see PAR. 20b).

f. *Loudspeaker:* The permanent magnet dynamic loudspeaker supplied with the Receiver has a transformer mounted on its housing. This transformer matches the voice coil of the loudspeaker to the 500-ohm output terminals (on terminal strip E3, FIG. 3) located at the rear of the chassis (marked 500 ohms). For loudspeaker operation,

connect the two-wire lead attached to the terminals of the loudspeaker transformer to the 500-ohm terminals on the Receiver. Disconnecting the loudspeaker will not impair the operation of the Receiver.

g. Power Transformer Primary Tap: Before plugging the power cord into the a-c line, remove bottom plate from Power Supply to see that power cord is properly connected for the a-c voltage of the power line being used. One wire of the power cord is permanently connected to the fuse-holder (E3, FIG. 5); the other wire is connected at the factory to one of the screw terminals on terminal strip E2 (FIG. 5). These screw terminals are marked 105, 115 and 125, and are connected to primary taps on the power transformer. See that the power cord is connected to the screw terminal most closely agreeing with the available a-c line voltage and replace the bottom cover plate.

h. Line Switch: Turn the OFF-ON switch (S7, FIG. 2) on the Receiver front panel to OFF and plug the power cord of the Power Supply into the a-c powerline.

8. PREPARATION FOR USE

a. Recheck: After installation, again look over the equipment for mechanical defects or damage caused by shipping, handling and so

b. Tubes: Receiver and Power Supply tubes are in their proper

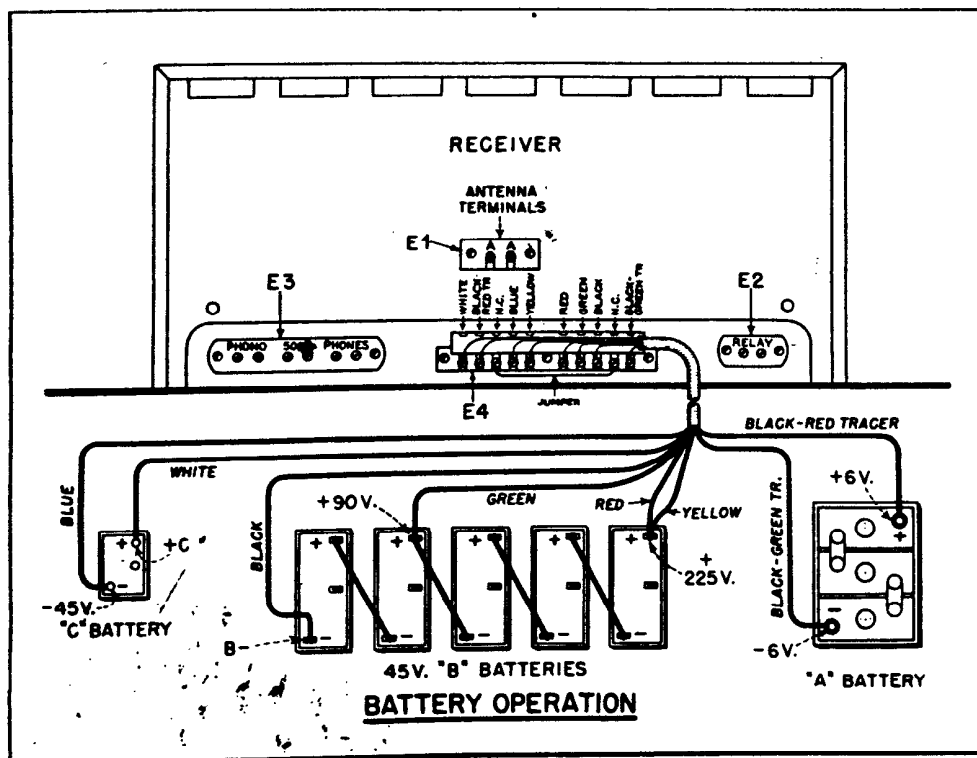

FIG. 4—Connections for power cable—battery operation.

sockets when this equipment is packed for shipment. Remove cardboard jackets from tubes in Power Supply and check to see that all tubes are in proper position before attempting to operate the Receiver.

(1) *Receiver:* To inspect tubes in the rack mounting type Receiver it is necessary to remove the dust cover. Do this by removing thumb nuts which hold cover to front panel and rear edge of chassis. Leave dust cover off until Receiver is operating satisfactorily. If Receiver is mounted in a cabinet, just raise lid in top of cabinet. The Receiver uses the following tubes:

REF. NO.	TYPE	FUNCTION
V1	6K7	1st RF Amplifier
V2	6K7	2nd RF Amplifier
V3	6L7	1st Detector (mixer)
V4	6J7	H-F Oscillator
V5	6K7	1st IF Amplifier
V6	6SK7	2nd IF Amplifier
V7	6SK7	3rd IF Amplifier
V8	6H6	2nd Detector
V9	6N7	Noise Limiter
V10	6SJ7	Beat Oscillator
V11	6SK7	AVC Amplifier
V12	6H6	AVC Rectifier
V13	6J5	1st AF Amplifier
V14	6F6	2nd AF Amplifier (driver)
V15	6F6	3rd AF Amplifier (output)
V16	6F6	3rd AF Amplifier (output)

The proper location of these tubes is shown in FIG. 7 and on the diagram attached to the top of the tuning unit. Make sure that tubes V1, V2, V3, V4, V5, V6, V7, V8, V9, V10, V11, V12, V13, V14, V15, V16 are properly connected to their grid caps.

(2) *Power Supply:* Remove the cabinet or dust cover from the Power Supply and remove the cardboard jackets from the two rectifier tubes. The Power Supply uses the following tubes:

REF. NO.	TYPE	FUNCTION
V1	5U4G	"B" Rectifier
V2	5Y3GT/G	"C" Rectifier

Tube 5U4G goes into the socket nearest the corner of the Power Supply chassis (see FIG. 6).

c. *Adjustments:* The Super-Pro is adjusted before shipping. No adjusting should be necessary except to check for the correct primary tap on the power transformer (PAR. 7g).

9. OPERATION

a. *Radiophone Reception:* Set the front panel controls (FIG. 2) as follows:

CONTROL	POSITION
CRYSTAL SELECTIVITY	OFF
PHASING	on arrow
BAND WIDTH	3
LIMITER	Off
AVC-MANUAL	AVC
SENSITIVITY	10
BAND SPREAD	100
SIGNAL-MOD-CW	MOD
AUDIO GAIN	6
SEND-REC	REC
BEAT OSCILLATOR	0

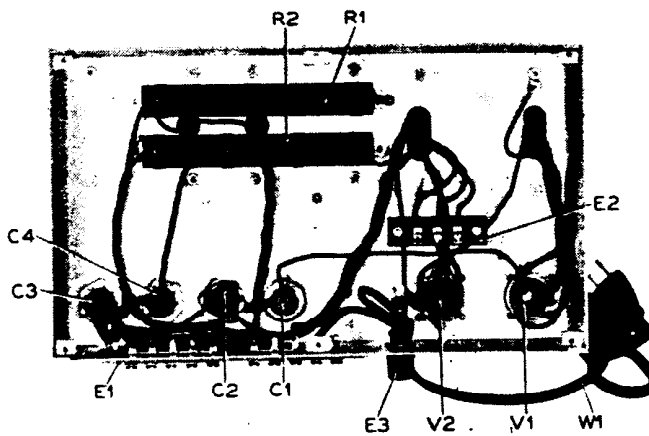
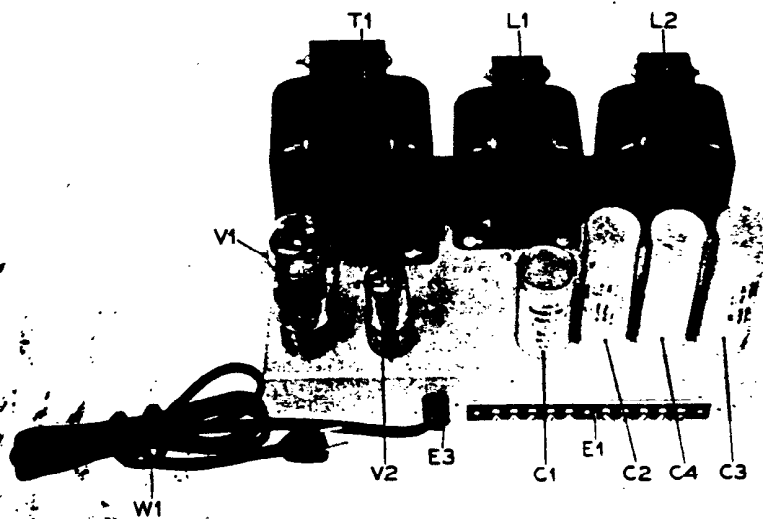

FIG. 5—Bottom view of power supply.

FIG. 6—Top view of power supply.



(1) Throw OFF-ON power switch in center of panel to ON. This puts Receiver in operation.

(2) Adjust band switch (S1, FIG. 2) to a band which is likely to be very active. This will facilitate the process of getting familiar with the various adjustments. If interference is not serious, BAND WIDTH control can be adjusted to a wider band width (higher number), depending upon the degree of fidelity desired. In general, adjust this control to band width giving best tone with least interference.

(3) Do all tuning, with or without the meter with BAND WIDTH control set at 3. Other settings give wider bands, making exact tuning difficult. Make band width adjustments *after* signal is tuned properly.

(4) LIMITER-OFF-ON control turns noise limiter on and off. The noise limiter will be most valuable on the higher frequencies, where interference from automobile ignition system is most bothersome.

b. *Code Reception:* Flip AVC-MANUAL switch to MANUAL and turn down SENSITIVITY control to provide proper sensitivity.

(1) On strong signals, do not turn SENSITIVITY control all the way on, because it will cause overloading. If the AUDIO GAIN control is set at 7, it is possible to regulate volume by using only the sensitivity control.

(2) To turn on the beat oscillator, set SIGNAL-MOD-CW switch at CW. The BEAT OSCILLATOR control varies the pitch of the beat between oscillator and incoming signal. Use beat oscillator for code reception and for locating weak modulated signals.

(3) Fading signals can be improved by returning AVC-MANUAL switch to AVC.

c. *Crystal Filter:* First three positions of CRYSTAL SELECTIVITY control, are generally used for radiophone reception and will serve for code reception where interference is not serious. Last two positions are intended for code reception *only* since they provide so narrow a band that "phone" signals are usually unintelligible. After adjusting CRYSTAL SELECTIVITY control for desired degree of selectivity, use PHASING control to eliminate or reduce any heterodyne interference or "whistle" which may be present.

d. *Receiver Silencing:* Receiver can be silenced by flipping the SEND-REC switch (S6, FIG. 2) to SEND. This operation opens the

"B" supply to the R-F and 1st detector tubes (V1, V2 and V3).

periods. Note also that instead of using the SEND-REC switch, a relay may be connected to the RELAY terminals (E2, FIG. 3) at rear of Receiver and silencing controlled by relay action, actuated, for ex-

flip SEND-REC switch to SEND (open) and leave it there. While the

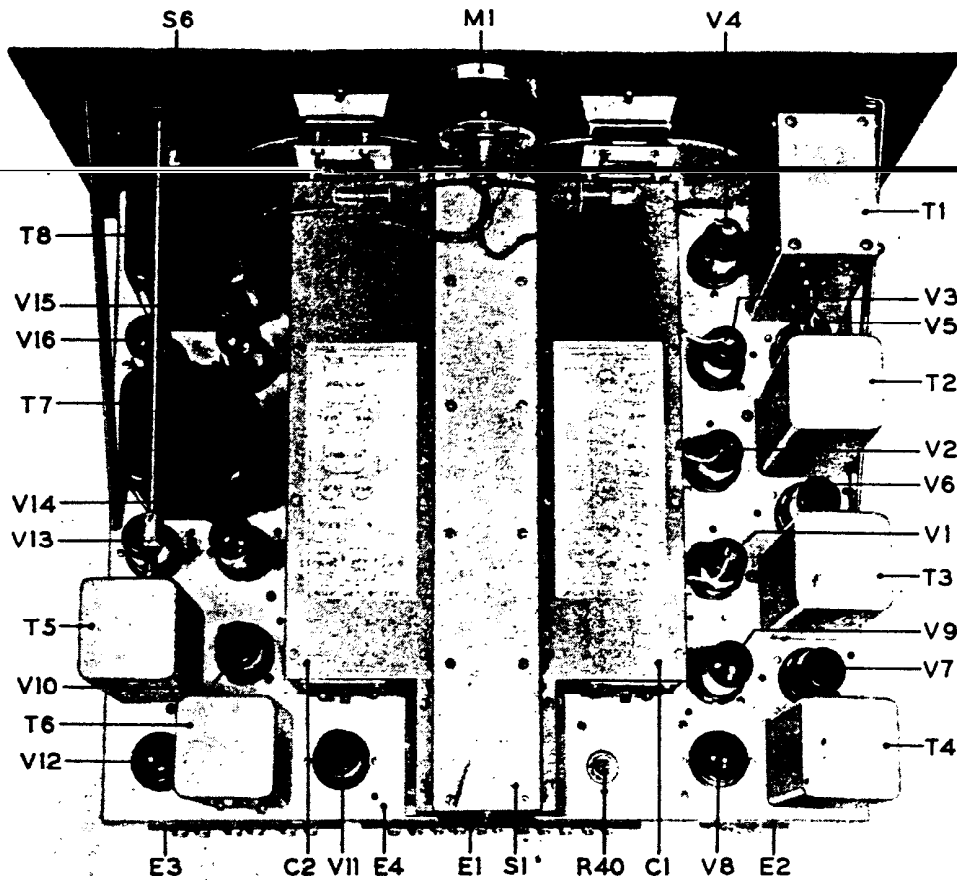

FIG. 7—Top chassis view showing arrangement of components.

transmitter is operating, the relay should remain *open*; when the transmitter is "off the air," the relay contacts should *close* to restore Receiver operation.

e. Phono Operation: Leads from a phonograph pickup may be connected to the PHONO terminals (on terminal strip E3, Fig. 3) at the rear of the Receiver. (Note that the left-hand terminal of this pair is grounded to chassis.) Use the SEND-REC switch (S6) as a "phono-radio" switch by flipping it to the SEND position, thus eliminating radio interference and making it unnecessary to hunt for a "dead spot" on the tuning dial.

f. Tuning: All tuning can be done with the MAIN TUNING control. In this case, leave the band spread dial at 100. BAND SPREAD control spreads out a narrow band of frequencies *below* the frequency to which the main dial is set. This control operates continuously throughout the entire tuning range of the Receiver, and signals can be spread out in any one of the five bands. See PAR. 4c.

g. *Earphone Operation:* For earphone operation, plug earphones into the PHONES jack (J1, FIG. 2) provided for them on the front panel, or connect them to the PHONES terminals on the rear of the Receiver chassis. These terminals are connected in parallel with the jack on the front panel.

h. *S-Meter Tuning:* The S-meter (M1, FIG. 2), a tuning guide, operates only when the Receiver is set for AVC. Its reading increases as the Receiver approaches resonance with the incoming signal. Exact resonance is shown by the greatest reading of the meter. BAND WIDTH control must be set at 3 for accurate tuning by means of the meter. A screwdriver adjustment (R40, FIG. 7) at the rear of the chassis varies the resistance in shunt with the meter. By means of this adjustment, an "S9" reading may be obtained on any input between approximately 10 and 10,000 microvolts. The normal factory adjustment is made on an input of 50 microvolts, and when so adjusted each "S" number represents a change in signal input of approximately 6 decibels, or a ratio of two-to-one.

SECTION III—CIRCUIT ARRANGEMENT

10. RF AMPLIFIER

a. *Antenna Circuit:* The antenna is coupled to the grid of the 1st RF amplifier (V1) through an input transformer having an untuned primary and tuned secondary. The terminals of the primary coils are ungrounded, and are connected through a double-pole section (S1A) of the band switch to the "A," "A" terminals (E1) on the rear of the tuning unit. This symmetrical arrangement of the antenna

properties of a balanced transmission line lead-in. The impedance of the input circuit averages approximately 100 ohms throughout the tuning range of the Receiver.

b. *Amplifier Stages:* There are two stages of RF amplification preceding the first detector or mixer. These stages are coupled by means of RF transformers having tuned secondaries and low inductance untuned primaries. The plates of the two RF amplifier tubes (V1, V2) are shunt fed through RF chokes L35, L36 and are coupled to their respective tuned circuits through fixed capacitors C26, C30. This shunt feed keeps plate voltage off the tuned RF amplifier circuits.

540-1240 KC band, normally provide more selectivity than is desired for the reception of high-fidelity programs. To prevent loss of audio quality resulting from RF side-band cutting, resistors (R4, R8) have been placed in series with the secondaries of RF transformers L14, L19, to broaden their pass band.

11. HF OSCILLATOR

The HF oscillator operates at a frequency 455 kc. (the frequency for which the IF amplifier is adjusted) *higher* than that of the incoming signal. The oscillator section of the variable tuning capacitor (C1D) has the same capacitance and plate shape as the RF sections (C1A, C1B, C1C). The constant 455 kc. frequency difference is maintained by means of a padding capacitor in series with the variable, together with appropriate values of oscillator inductance and parallel trimmer capacitance.

12. FIRST DETECTOR

The 1st detector employs a 6L7 pentagrid mixer (V3). Its injection grid (grid No. 3) is coupled to the HF oscillator cathode, and its signal grid (grid cap) is coupled to the plate of the second RF amplifier tube (V2) by means of the second RF transformer.

13. CRYSTAL FILTER

a. *Controls:* The Quartz Crystal Filter (T1) couples the 1st detector (V3) to the 1st IF amplifier (V5). Its selectivity can be varied

trolled from the front panel by knob and pointer. In addition, its selectivity characteristic can be greatly sharpened *on one side* or the other (to avoid heterodyne "whistle") by adjusting the PHASING capacitor (C46), also controlled by a knob on the front panel.

b. *Variable Selectivity:*

Curves A and B, FIG. 8, show Receiver selectivity curves which indicate certain effects of the Crystal Filter. When the CRYSTAL SELECTIVITY switch is set at OFF, the quartz crystal is short-circuited and signal voltages present in the secondary of the 1st detector plate coil (L26) are impressed directly on the control grid of the first IF amplifier tube (V5). At any other setting (1 to 5), the quartz crystal is in use and acts as an extremely high "Q," high impedance, series tuned circuit interposed, between the secondary of plate coil L26 and the 1st IF grid circuit (L27, C48), which constitutes the load into which the crystal

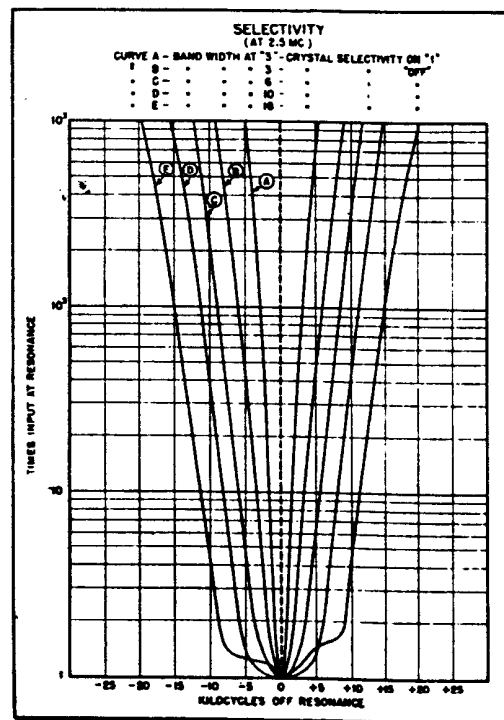

FIG. 8—Selectivity curves.

works. Selectivity is varied by altering the impedance of this parallel tuned circuit (L27, C48), which is accomplished by adding resistance. (R17, R18, R19, R20) in series with coil L27 and capacitor C48.

14. I-F AMPLIFIER

The intermediate-frequency amplifier has three stages consisting of three coupling transformers (T2, T3 and T4) and three pentode amplifier tubes (V5, V6 and V7) of the remote cutoff or super-control type. The first two transformers (T2, T3) are identical, and have tuned primaries as well as tuned secondaries. The secondary coils are fixed in position, while the primary coils are mounted on slide rods permitting them to move back and forth with respect to the secondaries, thus changing the degree of inductive coupling between them. When the coils are farthest apart the coupling is at its lowest value and the transformers exhibit their maximum selectivity or minimum band width. Conversely, when the coils are pushed close together the coupling is greatly increased and minimum selectivity or maximum band width results. At any adjustment between these two extremes, an intermediate degree of selectivity is obtained.

15. SECOND DETECTOR

The 2nd detector (V8) is a twin diode operated with both plates as cathodes connected in parallel. Its IF input is obtained

plate circuit of the 3rd IF amplifier (V7). To facilitate operation of the limiter tube (V9) the diode load resistance is divided into two and approximately equal parts. One part, R33, is placed between the paralleled cathodes and ground and is by-passed (for IF) by a small capacitor (C66). The other part is between the low-potential end of the secondary and ground, and is made up of R29, R30 and R31. Resistor R29 and two small capacitors (C64, C63) constitute a filter to prevent IF voltages from reaching resistor R31 and the AUDIO GAIN control (R48).

16. NOISE LIMITER

The noise limiter tube (V9) is a 6N7 class B twin triode with its two grids and its two plates connected in parallel in order to secure the lowest possible impedance. The circuit is designed to limit interference of momentary nature such as caused by auto ignition and other similar disturbances. It is designed to work with or without

levels. Some distortion results at higher modulation percentages but this is unavoidable if effective noise limiting is to be obtained. An "on-off" switch is provided.

17. AVC AMPLIFIER AND RECTIFIER

Special amplifier and rectifier stages are employed in order to give most satisfactory AVC action. AVC voltages are applied to the two RF stages and to the first two IF stages and compensate for variations in signal strength due to fading. A different rate of compensation is required for voice modulated signals than for code signals. This is automatically adjusted when the beat frequency oscillator is turned on or off.

18. "S" METER

The "S" or Signal Strength Meter (M1) is connected for use when the AVC-MANUAL switch (S5) is thrown to AVC. This meter shows the relative strength of the received signal. The centrally located dial

of the dial allows the meter to be adjusted to read "S-9"

10,000 microvolts. The normal factory adjustment for "S-9" is approximately 50 microvolts. Each division represents a ratio of approximately 2 to 1 over the previous division. Thus each division represents a 6db step. The sensitivity control (R46) must be set

at maximum (position 10) for maximum "S" meter accuracy. This "S" meter can also be used as a tuning meter since it will show maximum reading at resonance. In this case, to obtain a relatively sharp resonance indication, the BAND WIDTH control should be set at position 3.

19. BEAT OSCILLATOR

The beat oscillator tube (V10) and associated oscillator circuit (T5) provide a voltage at approximately the intermediate frequency. This voltage, when introduced into the input circuit of the 2nd detector (V8) by means of a small coupling capacitor (C60), mixes with the I-F signal being delivered to the detector by the 3rd I-F amplifier (V7). The mixture of these two similar frequencies results in a "beat" or difference frequency in the output of the 2nd detector. The beat oscillator frequency is adjusted so that the pitch of this difference

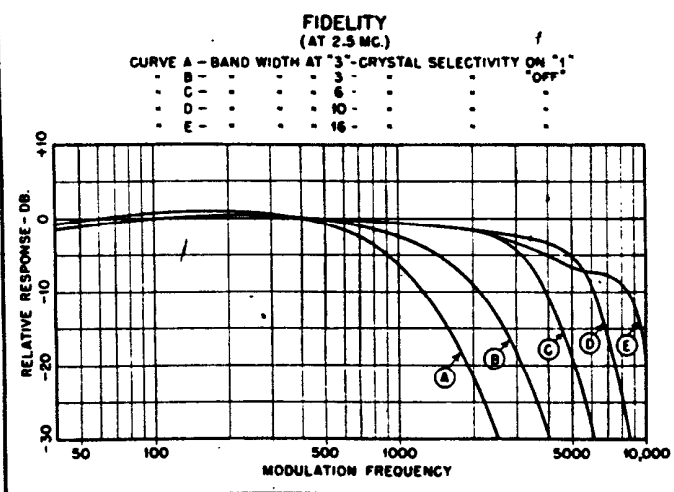

FIG. 9 - Audio fidelity curves.

frequency falls within the audio-frequency range. Fine adjustment of the beat frequency pitch is accomplished by means of the BEAT OSCILLATOR control on the front panel which turns a small variable capacitor (C69) in transformer T5. The beat oscillator is turned on by throwing the SIGNAL-MOD-CW switch (S4) to CW. In addition to being necessary for proper reception of CW signals, the beat oscillator is useful for locating weak signals of any kind.

20. AF AMPLIFIER

a. *Circuits:* The AF amplifier has three stages, using one 6J5 triode (V13) and three 6F6 pentodes (V14, V15, V16). The grid of the first tube (V13) is connected to the moving arm of the AUDIO GAIN control (R48) through a blocking capacitor (C82). Its plate is coupled to the grid of the second AF amplifier by means of capacitor C83, plate resistor R53 and grid leak R54. The second amplifier tube (V14), while a pentode, is operated as a triode by connecting its plate and screen together. It drives the output tubes (V15, V16) through a

also triode-connected pentodes and are operated as class AB₂ amplifiers.

b. *Output Transformer:* The output transformer (T8) has two secondary windings; a 500-ohm secondary (4-5) for power output, and a secondary for earphone (6-7) designed to deliver about 36% of the output power into an 8000-ohm resistive load when the 500-ohm secondary is connected to a matching load such as the loudspeaker (see PAR. 7f). The turns ratio and resistance of the earphone winding are such that the power delivered to any load between 8000 ohms and 80 ohms varies less than 6 db, and the power input to a 250-ohm load is but 2 db greater than that to a 4000-ohm load. FIG. 9 shows curves of overall audio fidelity with different settings of the CRYSTAL SELECTIVITY and BAND WIDTH controls.

21. POWER SUPPLY

The Power Supply furnishes "A," "B" and "C" voltages for the Receiver. The "A," or heater voltage, is 6.3 volts AC obtained from a separate secondary winding (1-2) on the power transformer (T1, FIG. 18). "B" voltage is obtained from the center-tapped high-voltage secondary (7-8-10) connected to the plates of the "B" rectifier tube (V1). After this voltage is rectified, it is filtered by the combined action of the first filter choke (L1) and the two filter capacitors C1 and C2. This provides 380 volts DC for the plates of the power output tubes in the Receiver. Further filtering by the second filter choke (L2) and the first two sections of capacitor C3 provides 250 volts DC for the plates of the remaining tubes in the Receiver. Approximately 100 volts DC for the screen grids of the Receiver tubes is obtained from the tap on the bleeder resistor (R1), which is by-passed by the remaining section of capacitor C3. Negative "C" voltage is obtained

TABLE 1 - INTERNAL CONNECTIONS TO TUBE BASE PINS

TUBE TYPE	BASE	PIN 1	PIN 2	PIN 3	PIN 4	PIN 5	PIN 6	PIN 7	PIN 8
6J5	octal	shell	heater	plate		grid		heater	cathode
6F6	octal	shell	heater	plate	screen	grid		heater	cathode
6Y3GT/8	octal	no conn.	filament		plate		plate		filament
*6K7	octal	shell	heater	plate	screen	suppressor		heater	cathode
*6L7	octal	shell	heater	plate	screen	inj. grid		heater	cathode
6N6	octal	shell	heater	plate (2)	cathode (2)	plate (1)		heater	cathode (1)
*6J7	octal	shell	heater	plate	screen	suppressor		heater	cathode
6N7	octal	shell	heater	plate (2)	grid (2)	grid (1)	plate (1)	heater	cathode
6SJ7	octal	shell	heater	suppressor	grid	cathode	screen	heater	plate
6SK7	octal	shell	heater	suppressor	grid	cathode	screen	heater	plate
8U48	octal	no conn.	filament		plate		plate		filament

* These types have grid caps

TABLE 3 - SOCKET TERMINAL RESISTANCE VALUES
(All measurements made between socket terminal and chassis)

TERMINAL NAME	PIN NO.	VARIABLE		RESISTANCE IN OHMS
		REF. NO.	SETTING	
RECEIVER				
V1 grid	CAP	SW4 SW4	AVC MAN	1,160,000 515,000
V1 plate	3	SW2 SW2	SEND REC	Infinity 18,032
V1 screen	4			11,500
V2 grid	CAP	SW4 SW4	AVC MAN	1,160,000 515,000
V2 screen	4	SW2	REC	19,972
V2 screen	4			11,500
V3 adj. grid	CAP			510,000
V3 plate	3	SW2 SW2	SEND REC	Infinity 20,000
V3 screen	4	SW2 SW2	SEND REC	Infinity 42,000
V3 inj. grid	5			50,000
V4 grid	CAP			50,000
V4 plate	3,4,5			30,000
V4 cathode	8			.01 - 1.2"
V5 grid	CAP	SW4 RS6 SW4 RS6	AVC MAN 0 MAN 10	670,000 14,600 10,300
V5 plate	3			20,000
V5 screen	4			11,500
V6 grid	4	SW4 RS6 SW4 RS6	AVC MAN 0 MAN 10	670,000 14,600 10,300
V9 cathode	8	SW5 SW5	ON OFF	117,000 Infinity
V10 grid	4			100,000
V10 screen	6	SW3 SW3	CV MOD	523,000 Infinity
V10 plate	8	SW3 SW3	CV MOD	73,000 Infinity
V11 grid	4			10,300
V11 screen	6			68,000
V11 plate	8			20,000
V12 plates	3,5			34,300
V13 plate	3			69,000
V13 grid	5			510,000
V14 plate	3,4			18,600
V14 grid	5			510,000
V15 plate	3,4			19,800
V15 grid	5			320
V15 cathode	8			750
V16 plate	3,4			19,400
V16 grid	5			320
V16 cathode	8			750

*Varies with BAND SWITCH setting

**with V9 removed from socket

TABLE 2 - TUBE SOCKET VOLTAGES (RECEIVER)

Socket No.	Tube No.	VOLTS AT SOCKET TERMINAL NUMBER*					
		3	4	5	6	7	8
X1	V1	+250	+135		+135	6.3AC	0
X2	V2	+250	+135		+135	6.3AC	0
X3	V3	+250	+115			6.3AC	0
X4	V4	+150**	+150**	+150**		6.3AC	
X5	V5	+250	+135	0		6.3AC	0
X6	V6	0	-43	0	+135	6.3AC	+250
X7	V7	0	-1.5	0	+100	6.3AC	+240
X8	V8	-.2	+4	-.2		6.3AC	+4
X9	V9	+4	0	0	+4	4.0AC	-.2
X10	V10	0		0	+40	6.3AC	+155
X11	V11	0	-1.5	0	+110	6.3AC	+240
X12	V12	-3.2	0	-3.2		6.3AC	0
X13	V13	+110			-3.2	6.3AC	0
X14	V14	+240	+240		-20	6.3AC	0
X15	V15	+380	+380	0		6.3AC	+38
X16	V16	+380	+380	0		6.3AC	+38

*Terminals 1 and 2 of all sockets are at zero potential with respect to chassis.

**Varies widely with different tubes; also with dial setting.

The above voltage readings are based on an a-c line voltage exactly equal to the primary tap on the power transformer - higher or lower line voltage should result in corresponding variations in these readings.

All d-c readings are based on the use of a meter having a resistance of 1000 ohms per volt, and are taken between socket terminals and chassis.

SENSITIVITY and AUDIO GAIN should be set at a 0.

SIGNAL-MOD-CW switch should be on CW.

AVC-MANUAL switch should be on MANUAL.

SEND-REC switch should be on REC.

LIMITER switch should be ON.

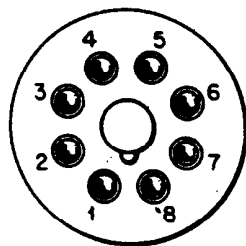

OCTAL BASE

(BOTTOM VIEW)

**TABLE 4
SOCKET TERMINAL RESISTANCE VALUES**

(All measurements made between socket terminal and chassis)

POWER SUPPLY

TERMINAL NAME	PIN NO.	RESISTANCE IN OHMS
V1 plate	4	40
V1 plate	6	40
V1 filament	2, 8	19,500
V2 plates	4, 6	28,500
V2 filament	2, 8	22

FIG. 11—Tube socket terminals.

by-pass capacitor or an open resistor. Remove the cabinet or bottom cover plate to get at all parts. Measure socket voltages and compare them with TABLE 2. (Consult FIG. 11 and TABLE 1 for key to tube base pin connections.) If this measurement does not reveal the trouble, start checking socket terminal resistance values against TABLE 3. (Receiver) or TABLE 4 (Power Supply). Obtain values of resistors and capacitors by locating the reference number on the proper circuit diagram and looking it up in the Table of Parts, Section V. In checking these resistance values be sure to set the "variable" controls to the positions specified in the table.

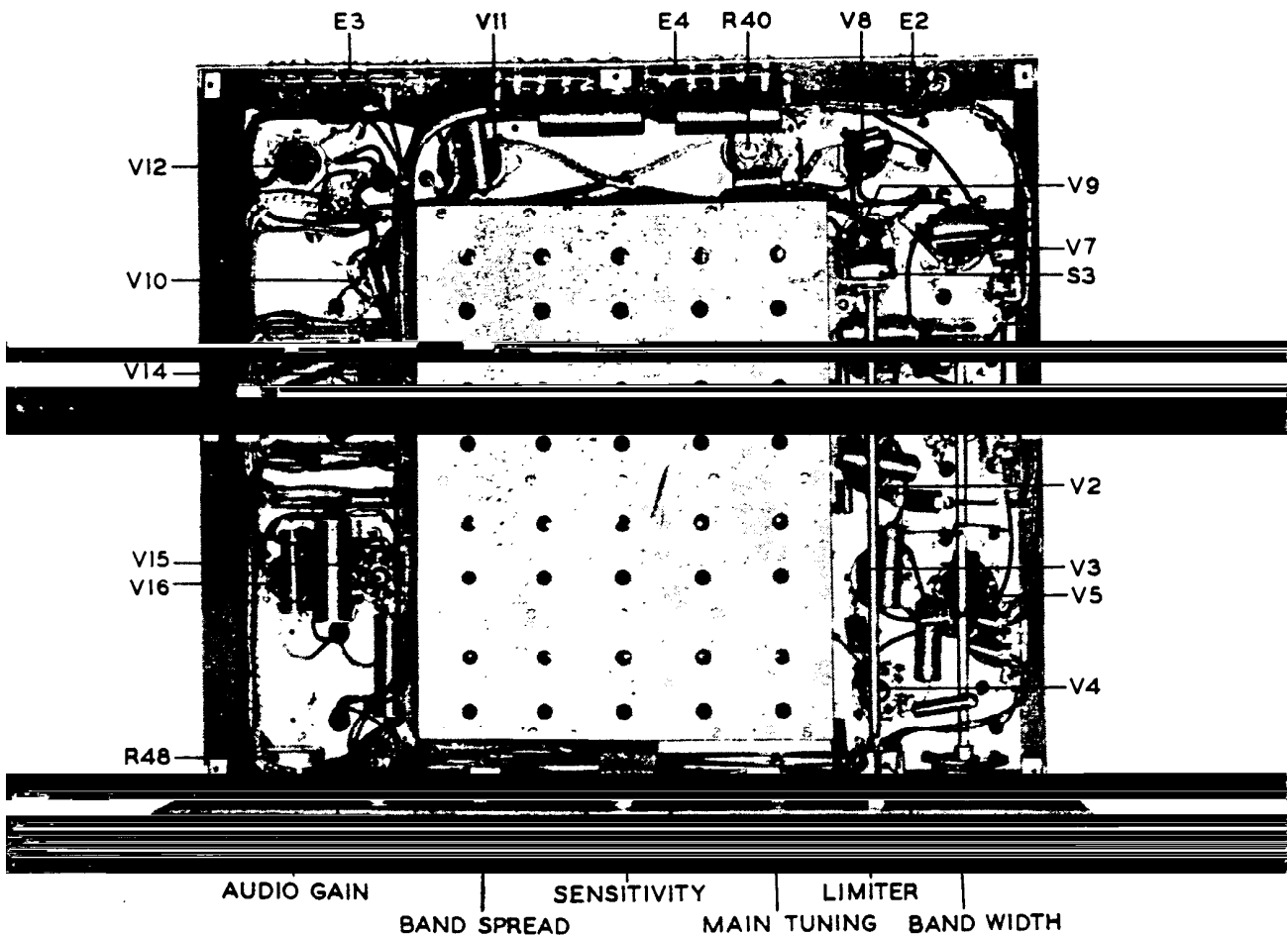

FIG. 12—Bottom view of chassis.

25. ALIGNMENT—GENERAL

When either selectivity or sensitivity or both appear to be below normal and *all tubes have been tested*, check the alignment. Remove the dust cover or cabinet and bottom cover plate of the Receiver to get at all parts for making adjustments. CAUTION: ANY CHANGES FROM ORIGINAL SETTINGS WILL BE SMALL SO USE GREAT CARE WHEN CHECKING ADJUSTMENTS. This is especially true of the HF oscillator

circuits, which should NOT be disturbed unless the MAIN TUNING dial is definitely known to be off calibration.

a. *Signal Generator:* This should be an accurately calibrated instrument producing amplitude-modulated radio-frequency signals. In addition to 455 kc. (the IF), the frequency range required of the signal generator depends on the tuning range of the receiver to be aligned. The RF alignment frequencies required for the Series 400-X Super-Pro are shown in FIG. 13. The second harmonic can generally be used when the fundamental frequency is not available. For example, a signal generator covering all frequencies from 455 kc to 15 mc could be used to check the highest frequency band by using the second harmonic of 15 mc to provide the 30 mc called for in FIG. 13. The signal generator should have an output of approximately 100 microvolts and an output impedance of approximately 100 ohms for best results when aligning the RF and HF Oscillator circuits. For IF alignment these values are not critical. The frequency calibration of the signal generator is extremely important if the Receiver dial calibration is to be correct.

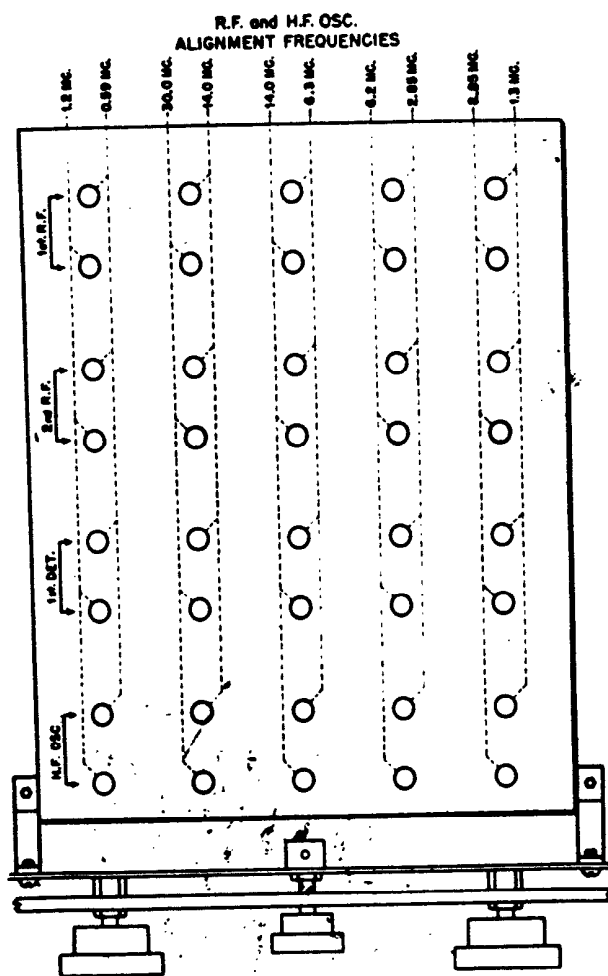

b. *Output Meter:* The output meter should respond to the modulation frequency of the signal generator, preferably 400 cps, and should provide at least half-scale deflection for 10 volts. Its resistance should be greater than 500 ohms.

c. *Tools:* An insulated screwdriver 9/64" wide and .025" thick at the bit, is required for alignment of the Receiver.

d. *Preliminary Procedure:* Throw the OFF-ON switch to ON and permit the Receiver to warm up for about an hour before beginning adjustments. Connect the output meter to the 500-ohm terminals located at the rear of the Receiver chassis (see PAR. 7f).

FIG. 13—R.F. and H.F. osc. alignment frequencies and location of adjustments

26. ALIGNMENT PROCEDURE

455 kc and connect its output to the control grid cap of the 1st detector tube (V5) through a fixed capacitor (a 100 mmf will do). Set the front panel controls as follows:

SENSITIVITY	0
AVC-MANUAL	MANUAL
SIGNAL-MOD-CW	MOD
SEND-REC	REC
BAND SWITCH	2.85-6.3 mc
AUDIO GAIN	10

BAND WIDTH	3
BAND SPREAD DIAL	100

b. IF Alignment Check:

(1) Set the MAIN TUNING dial near 2.85 mc, but be careful not to tune in a powerful local signal. Set the CRYSTAL SELECTIVITY switch on 3, the AVC-MANUAL switch on AVC, and advance the SENSITIVITY to 10. Turn off the modulation of the signal generator and adjust its frequency slightly to produce maximum deflection of the "S" meter. The adjustment of the signal generator in this manner

is necessary in order to get exact agreement with the natural period of the particular quartz crystal in the Receiver being checked. After reducing SENSITIVITY to 0, the modulation may be switch on, but the tuning adjustment of the signal generator must not be altered until the alignment check has been completed. Return the CRYSTAL SELECTIVITY and AVC-MANUAL controls to their original settings of OFF and MANUAL and advance the SENSITIVITY control until a suitable output meter reading is obtained. A half-scale reading in the region of 5 to 10 volts will be satisfactory.

(2) Now check the alignment of both upper (grid) and lower (plate) air trimmer capacitors in IF transformers T2 and T3 and the single trimmer in T4 for peak reading of the output meter. If one or more of these adjustments results in a sizeable increase in output, reduce the SENSITIVITY control enough to bring the meter reading back to half-scale. Alignment of the plate circuit of the crystal filter (T1) can be tested in the same way by means of the lower adjusting screw on the side of the unit. This screw varies the position of the powdered iron core in coil L26. Do not change the setting of the upper adjusting screw which tunes grid coil L27, as this circuit cannot be adjusted properly with the output meter. It can, however, be aligned by the "visual" method using a frequency-modulated signal

generator and cathode-ray oscilloscope. If this equipment is available, proceed as follows:

(3) Connect the input of the vertical amplifier of the oscilloscope to the PHONO connections on Terminal strip E3 (FIG. 7) on the rear skirt of the Receiver chassis. The "high" terminal is the second one from the edge of the strip; the first screw is connected to the chassis. Set the frequency-modulated signal generator to approximately 455 kc and connect its output to the control grid cap of the 1st detector (V3) through a fixed capacitor (100 mmf or larger). With the CRYSTAL SELECTIVITY switch at OFF, readjust the signal generator frequency to produce the conventional single-peaked resonance curve on the screen of the oscilloscope. Then turn the CRYSTAL SELECTIVITY switch to position 1. If the grid coil (L27) is correctly tuned the image on the oscilloscope screen will remain symmetrical but will be only about two-thirds as wide as before, indicating an increase in selectivity. The oscilloscope image is also affected by the PHASING control, maximum symmetry occurring at or very near the arrow on its scale. Therefore, when tuning L27, rock the PHASING control back and forth at the same time to secure the best adjustment.

c. *AVC Alignment Check:* Leaving all other controls as in PAR. 26a, and without changing the signal generator frequency, reduce AUDIO GAIN to 0, switch to AVC and increase SENSITIVITY to 10. Increase AUDIO GAIN to restore half-scale reading on the output meter and adjust the single trimmer capacitor in T6 for *minimum* output meter reading. The "S" meter reading should "peak" at the same time the output meter reading "dips."

d. *Beat Oscillator Alignment Check:* Continuing with controls as above (PAR. 26c), switch off the output meter and plug in a pair of earphones, or replace the meter with a suitable loudspeaker. Turn the SIGNAL-MOD-CW switch to CW and see that the BEAT OSCILLATOR control is exactly on 0 (zero). If tone in earphones or speaker is not very low in pitch, readjust the trimmer capacitor near the bottom of T5 until it is. If the beat oscillator is in perfect alignment when this test is made, no sound will be heard since the signal generator and the beat oscillator will be oscillating at the same frequency and there will be no audible difference or "beat." Check this by turning the BEAT OSCILLATOR control knob slightly off 0 (zero) toward one side or the other. If this results in a tone rising in pitch as the pointer is turned away from 0 (zero) to either side, the beat frequency oscillator is perfectly aligned. If no audible tone can be obtained within the range of the BEAT OSCILLATOR control, adjust the trimmer capacitor near the bottom of T5 until an approximate "zero beat" occurs at 0 (zero) setting of the BEAT OSCILLATOR control.

e. HF Oscillator Calibration Check: The accuracy of the MAIN DIAL calibration depends solely on the HF oscillator frequency, which in this Receiver is 455 kc. (the IF) *higher* than the signal frequency. Although the frequency of the HF oscillator can be measured directly if accurate frequency-measuring equipment is on hand, it is far simpler to check it by tuning in signals of known frequency, and noting the MAIN DIAL readings. CAUTION: BE SURE THE BAND SPREAD DIAL IS SET AT 100 WHEN MAKING THIS TEST.

(1) To correct dial calibration, refer to alignment chart (FIG. 13) for location of HF oscillator adjustments as well as signal frequencies at which settings should be made. The output of the signal generator should be unmodulated and SIGNAL-MOD-CW switch on Receiver turned to CW. Set BEAT OSCILLATOR at 0, AUDIO GAIN at 10, AVC-MANUAL on MANUAL, BAND WIDTH at 16. Disconnect output meter and use earphones or loudspeaker to make necessary adjustments by "zero beat" method. Connect signal generator to antenna terminals for this test.

(2) If the 2.85-6.3 mc band is to be corrected, tune signal generator accurately to 6.3 mc. Tune in signal generator signal at 6.3 mc end of Receiver dial to zero beat. Notice approximate dial error. Turn main dial slightly toward 6.3 mc calibration line until beat note rises to a high pitch. Do not turn dial far enough to raise beat so high it cannot be heard. With alignment screwdriver adjust trimmer capacitor marked HF OSC 6.3 mc (FIG. 13) until beat is again zero. Turn main dial still farther toward 6.3 mc line and make a further adjustment of trimmer capacitor to return to zero beat. Repeat this process as often as necessary to bring dial to exactly 6.3 mc. (The main dial could be set at once on exactly 6.3 mc and trimmer turned enough at one time to produce zero beat, but the step-by-step method is recommended.) Now retune signal generator to exactly 2.85 mc and tune in signal-generator signal at low-frequency end of main dial and correct the calibration step-by-step as before, using inductance trimming adjustment HF OSC 2.85 mc (FIG. 13). When 6.3 mc signal from signal generator is again tuned in at other end of dial, it will be found that inductance adjustment at 2.85 mc has changed correction previously made at 6.3 mc. This is normal. Go back and forth several times from 2.85 to 6.3 mc in order to bring both ends of dial scale into exact agreement with the signal frequency. CAUTION: DURING THIS ADJUSTMENT BE VERY CAREFUL TO ADJUST THE SENSITIVITY CONTROL TO AVOID OVERLOADING.

f. RF and 1st Detector Alignment Check: Although alignment of these three circuits (1st and 2nd RF and 1st Det) can be checked at the same time as the HF oscillator, it is simpler to consider each check

as a separate operation. Efficient weak-signal reception, with low receiver noise level and high image rejection ratios, depends on the relative alignment of these three circuits with respect to the HF oscillator and without regard to calibration accuracy.

(1) Accurate calibration of the signal generator is not required to check these adjustments. Modulation of the signal generator, while convenient, is not strictly necessary. Input to antenna terminals should be through 100 ohms (approximate) including output resistance of signal generator. If signal generator is modulated, Receiver controls should be set as for IF alignment; if unmodulated, set BEAT OSCILLATOR to 2 (either side) and SIGNAL-MOD-CW to CW. Adjust SENSITIVITY for half-scale reading on output meter when signals are exactly in tune.

(2) Starting with 2.85-6.3 mc band, set main dial at 6.3 mc (BAND SPREAD at 100) and adjust frequency of signal generator for peak deflection of output meter. Then check setting of trimmer marked 1st DET 6.3 mc (FIG. 13). Repeat this procedure on trimmers designated as 2nd RF and 1st RF in same row. If readjustments on one of these settings greatly increases output meter reading, alter SENSITIVITY slightly to reduce reading to half-scale. After each adjustment check tuning of Receiver to make sure test signal is still accurately tuned. BAND SPREAD may be used as a vernier for this purpose.

CAUTION: THIS TUNING CHECK IS EXTREMELY IMPORTANT AT HIGH END OF 6.3-14.0 MC AND 13.4-30.0 MC BANDS WHERE THERE IS SOME SLIGHT INTERACTION BETWEEN 1ST DET AND HF OSC CIRCUITS. After checking the three trimmers at high end of this band, turn main dial to 2.85 mc and retune signal generator to suit. Then check the three inductance adjuster settings marked 2.85 mc (FIG. 13) in the same row. Since adjustments at one end of a band also affect the other end of the band (as described under HF OSC alignment), repeat above procedure until no further improvement can be secured. The number of repetitions necessary depends on how much mistuning existed initially. Other bands may be checked in the same manner.

(3) For best possible efficiency with a particular antenna arrangement, the 1st RF circuits may be adjusted with the antenna connected. This can be done by loosely coupling output of signal generator to antenna system instead of directly to antenna terminals through a 100-ohm resistor. Make sure that signal from signal generator actually reaches Receiver by way of antenna rather than by some form of direct coupling.

(4) In all the foregoing tests using output meter readings for circuit adjustment it is recommended that earphones (or speaker) be used to monitor the signal. This will avoid false adjustments caused by overloading or freakish responses.

TABLE OF PARTS

CIRCUIT REF. No.	DESCRIPTION	PART No.
C1	CAPACITORS Main Tuning	
C4	.02 mf, Paper	23912-1
C5	.05 mf, Paper	23912-2
C6	Trimmer, Mica, 3-30 mmf	Part of 29529-G1
C7	Trimmer, Mica, 3-30 mmf	Part of 29532-G1
C8	Trimmer, Mica, 3-30 mmf	Part of 29538-G1
C9	Trimmer, Mica, 3-30 mmf	Part of 29520-G1
C10	Trimmer, Mica, 3-30 mmf	Part of 29535-G1
C11	Trimmer, Mica, 3-30 mmf	Part of 29530-G1
C12	Trimmer, Mica, 3-30 mmf	Part of 29533-G1
C13	Trimmer, Mica, 3-30 mmf	Part of 29539-G1
C14	Trimmer, Mica, 3-30 mmf	Part of 29521-G1
C15	Trimmer, Mica, 3-30 mmf	Part of 29536-G1
C16	Trimmer, Mica, 3-30 mmf	Part of 29530-G1
C17	Trimmer, Mica, 3-30 mmf	Part of 29533-G1
C18	Trimmer, Mica, 3-30 mmf	Part of 29539-G1
C19	Trimmer, Mica, 3-30 mmf	Part of 29521-G1
C20	Trimmer, Mica, 3-30 mmf	Part of 29536-G1
C21	Trimmer, Air, 4-25 mmf	Part of 29531-G1
C22	Trimmer, Air, 4-25 mmf	Part of 29534-G1
C23	Trimmer, Air, 4-25 mmf	Part of 29540-G1
C24	Trimmer, Air, 4-25 mmf	Part of 29528-G1
C25	Trimmer, Air, 4-25 mmf	Part of 29537-G1
C26	300 mmf, Silver Mica	23003-105D
C27	620 mmf, Mica	23005-86
C28	.02 mf, Paper	23912-1
C29	.05 mf, Paper	23912-2
C30	300 mmf, Silvered Mica	23003-105D
C31	620 mmf, Mica	23005-86
C32	.02 mf, Paper	23912-1
C33	.05 mf, Paper	23912-2
C34	95 mmf, Silvered Mica	6195
C35	673 mmf, Silvered Mica	Part of 29531-G1
C36	1500 mmf, Silvered Mica	Part of 29534-G1
C37	3300 mmf, Silvered Mica	Part of 29537-G1
C38	300 mmf, Silvered Mica	Part of 29528-G1
C39	51 mmf, Silvered Mica	23003-50
C40	.05 mf, Paper	23912-2
C41	.05 mf, Paper	23912-2
C42	120 mmf, Silvered Mica	23003-96
C43	100 mmf, Mica	23001-48
C44	100 mmf, Mica	23001-48
C45	NOT USED	
C46	Trimmer, Air, 2-6 mmf (ea.)	SA-179
C47	.02 mf, Paper	23912-1
C48	85 mmf, Silvered Mica, 2%	6180
C49	.05 mf, Paper	23912-2
C50	Variable, Air, 100 mmf	SA-1
C51	.05 mf, Paper	23912-2
C52	.05 mf, Paper	23912-2
C53	Variable, Air, 100 mmf	SA-1
C54	.05 mf, Paper	23912-2
C55	Variable, Air, 100 mmf	SA-1
C56	.05 mf, Paper	23912-2
C57	.05 mf, Paper	23912-2
C58	Variable, Air, 100 mmf	SA-1

TABLE OF PARTS—Cont.

CIRCUIT REF. No.	DESCRIPTION	PART No.
	<i>CAPACITORS—Continued</i>	
C59	.05 mf, Paper	23912-2
C60	5 mmf, Silvered Mica	23003-75
C61	Variable, Air, 100 mmf	SA-1
C62	.05 mf, Paper	23912-2
C63	51 mmf, Mica	23001-59
C64	51 mmf, Mica	23001-59
C65	.05 mf, Paper	23912-2
C66	51 mmf, Mica	23001-59
C67	Variable, Air, 100 mmf	SA-197
C68	100 mmf, Mica	23001-48
C69	Variable Air, 9 mmf	SA-170
C70	95 mmf, Silvered Mica	6195
C71	620 mmf, Mica	23005-86
C72	25 mf, Paper	23912-38
C73	.05 mf, Paper	23912-2
C74	.05 mf, Paper	23912-2
C75	Variable, Air, 100 mmf	SA-1
C76	5100 mmf, Mica	23015-16
C78	.05 mf, Paper	23912-2
C79	.05 mf, Paper	23912-2
C80	.05 mf, Paper	23912-2
C81	.05 mf, Paper	23912-2
C82	.02 mf, Paper	23912-1
C83	.05 mf, Paper	23912-2
C84	40 mf, Electrolytic, Dry	6171
C85	25 mf, Paper	23912-38
C86	25 mf, Paper	23912-38
	<i>COILS</i>	
L1	Assembly, Antenna transformer, 1.24-2.86 mc	29529-G1
L2	Assembly, Antenna transformer, 2.85-6.3 mc	29532-G1
L3	Assembly, Antenna transformer, 13.4-30.0 mc	29538-G1
L4	Assembly, Antenna transformer, 540-1240 kc	29520-G1
L5	Assembly, Antenna transformer, 6.3-14.0 mc	29535-G1
L6	Not Used	
L7	Not Used	
L8	Not Used	
L9	Not Used	
L10	Not Used	
L11	Assembly, R.F. transformer, 1.24-2.86 mc	29530-G1
L12	Assembly, R.F. transformer, 2.85-6.3 mc	29533-G1
L13	Assembly, R.F. transformer, 13.4-30.0 mc	29539-G1
L14	Assembly, R.F. transformer, 540-1240 kc	29521-G1
L15	Assembly, R.F. transformer, 6.3-14.0 mc	29536-G1
L16	Assembly, Same as L11	29530-G1
L17	Assembly, Same as L12	29533-G1
L18	Assembly, Same as L13	29539-G1
L19	Assembly, Same as L14	29521-G1
L20	Assembly, Same as L15	29536-G1
L21	Assembly, Oscillator Coil, 1.24-2.86 mc	29531-G1
L22	Assembly, Oscillator Coil, 2.85-6.3 mc	29534-G1
L23	Assembly, Oscillator Coil, 13.4-30.0 mc	29540-G1
L24	Assembly, Oscillator Coil, 540-1240 kc	29528-G1
L25	Assembly, Oscillator Coil, 6.3-14.0 mc	29537-G1
L26	Universal, 7/41 Litz., iron dust core	6146
L27	Universal, 7/41 Litz., iron dust core	6147
L28	3 pie universal 7/41 Litz., ceramic core	2903-A

TABLE OF PARTS—Cont.

CIRCUIT REF. No.	DESCRIPTION	PART No.
	<i>COILS—Continued</i>	
L29	3 pie universal 7/41 Litz., ceramic coil	3990
L30	Same as L28	2903-A
L31	Same as L29	3990
L32	Universal, 7/41 Litz., ceramic core	4907
L33	3 pie universal 7/41 Litz., ceramic coil	2931
L34	Universal, 7/41 Litz., ceramic core	4906
L35	Choke Coil, 5 pie universal R.F. choke, ceramic core, wire leads	609-1
L36	Choke Coil, Same as L35	609-1
J1	JACK, JK-34-A, Phone Jack (headset)	5066
M1	Meter, 0-200 micro-ampere movement	4903
	<i>RESISTORS</i>	
R1	500,000 ohms, 1/2 W	4959
R2	10,000 ohms, 1/2 W	19309-73
R3	2,000 ohms, 1/2 W	19301-206
R4	20 ohms, 1/2 W	19301-183
R5	500,000 ohms, 1/2 W	4959
R6	10,000 ohms, 1/2 W	19309-73
R7	2,000 ohms, 1/2 W	19301-206
R8	20 ohms, 1/2 W	19301-183
R9	500,000 ohms, 1/2 W	4959
R10	10,000 ohms, 1/2 W	19309-73
R11	50,000 ohms, 1/2 W	4960
R12	24,000 ohms, 2 W	19304-202
R13	50,000 ohms, 1/2 W	4960
R14	12,000 ohms, 2 W	19304-44
R15	2,000 ohms, 1/2 W	19301-206
R16	10,000 ohms, 1/2 W	19309-73
R17	24 ohms, 1/2 W	19301-178
R18	51 ohms, 1/2 W	19301-187
R19	300 ohms, 1/2 W	19301-196
R20	2,000 ohms, 1/2 W	19301-206
R21	2,000 ohms, 1/2 W	19301-206
R22	2,000 ohms, 1/2 W	19301-206
R23	10,000 ohms, 1/2 W	19309-73
R24	2,000 ohms, 1/2 W	19301-206
R25	2,000 ohms, 1/2 W	19301-206
R26	10,000 ohms, 1/2 W	19309-73
R27	51,000 ohms, 1 W	19303-182
R28	2,000 ohms, 1/2 W	19301-206
R29	100,000 ohms, 1/2 W	19301-80
R30	75,000 ohms, 1/2 W	19301-215
R31	51,000 ohms, 1/2 W	19301-171
R32	1 Megohm, 1/2 W	19301-104
R33	240,000 ohms, 1/2 W	19301-155
R34	4 ohms, 5 W	19431-1
R35	100,000 ohms, 1/2 W	19301-80
R36	510,000 ohms, 1/2 W	19309-159
R37	5,100 ohms, 1/2 W	19301-210
R38	51,000 ohms, 1/2 W	19301-171
R39	51,000 ohms, 1 W	19303-182
R40	1,000 ohms, Potentiometer	4932
R41	2,000 ohms, 1/2 W	19301-206
R42	24,000 ohms, 1/2 W	19301-213
R43	10,000 ohms, 1/2 W	19309-73
R44	1 Megohm, 1/2 W	19301-104
R45	2 Megohm, 1/2 W	19301-169

TABLE OF PARTS—Cont.

CIRCUIT REF. NO.	DESCRIPTION	PART No.
	RESISTORS—Continued	
R46	50,000 ohms, Potentiometer	5023
R47	4 ohms, 5 W	19431-1
R48	250,000 ohms, Potentiometer	4919
R49	510,000 ohms, 1/2 W	19309-159
R50	300 ohms, 1/2 W	19301-196
R51	1,800 ohms, 1/2 W	19301-38
R52	3,000 ohms, 1 W	19303-169
R53	51,000 ohms, 1 W	19303-182
R54	510,000 ohms, 1/2 W	19309-159
R55	750 ohms, 10 W	19430-30
	SWITCHES	
S1	10 pole, 5 position, 5 section	
S2	Wafer type, 6 position	4911
S3	SPST rotary snap	4916
S4	DPST rotary snap	5733
S5	DPST toggle	2990
S6	SPST rotary snap	5729
S7	DPST toggle	2983-1
	TRANSFORMERS	
T1	Filter Assembly, Variable selectivity quartz crystal filter,	29555-G1
T2	Variable selectivity I.F. transformer	SA-166A
T3	Same as T2	SA-166A
T4	Fixed selectivity, I.F. transformer	SA-167A
T5	455 kc oscillator assembly	SA-169A
T6	Fixed selectivity, I.F. transformer	SA-168A
T7	A.F. transformer, push-pull input	4887
T8	A.F. transformer, push-pull output	4888
	TUBES	
V1, V2, V5	6K7	16244-1
V3	6L7	16212-1
V4	6J7	16220-1
V6, V7, V11	6SK7	16245-1
V8, V12	6H6	16202-1
V9	6N7	16246-1
V10	6SJ7	16236-1
V13	6J5	16209-1
V14, V15, V16	6F6	16239-1
W1	Connector Cable, Nine wire, with two 10 terminal connector strips	SA-35
W2	Connector Cable, Eight wire, with one 10 terminal connector strip (special order only)	SA-67
X1-X4	Tube Socket, Molded octal, low-loss bakelite	16082-1
X5-X16	Tube Socket, Molded octal, black bakelite	16083-1

TABLE OF PARTS—Cont.

CIRCUIT REF. NO.	DESCRIPTION	PART No.
	POWER SUPPLY	
	<i>CAPACITORS</i>	
C1	Paper 1 mf, 1000 VDCW	23843-4
C2	16 mf, 600 VDCW, Dry Electrolytic	23842-13
C3-A-B-C	8-8-8 mf, 450 VDCW Dry Electrolytic	23842-28
C4-A-B-C	8-8-8 mf, 450 VDCW Dry Electrolytic	23842-28
E3	Fuse Holder	15923-1
F1	Fuse, 2 amp. 250 V, glass enclosed	15928-7
L1	Filter Choke, 160 ohms, 25h at 160 ma.	2981
L2	Filter Choke, 1150 ohms, 50h at 110 ma.	4819
	<i>RESISTORS</i>	
R1	18,000 ohms tapped at 9500, 10 watt	4946
R1A	8500 ohms	Part of R1
R1B	9500 ohms	Part of R1
R2	18,000 ohms tapped at 6500, 6500, 10 watt	3997
R2A	5000 ohms	Part of R2
R2B	6500 ohms	Part of R2
R2C	6500 ohms	Part of R2
	<i>TRANSFORMER</i>	
T1	50-60 cycle, primary tapped at 105, 115, 125V	4801
	<i>TUBES</i>	
V1	5U4G	16215-1
V2	5Y3GT/G	16252-1
X1.X2	Tube Socket, Molded Octal, black bakelite	16083-1

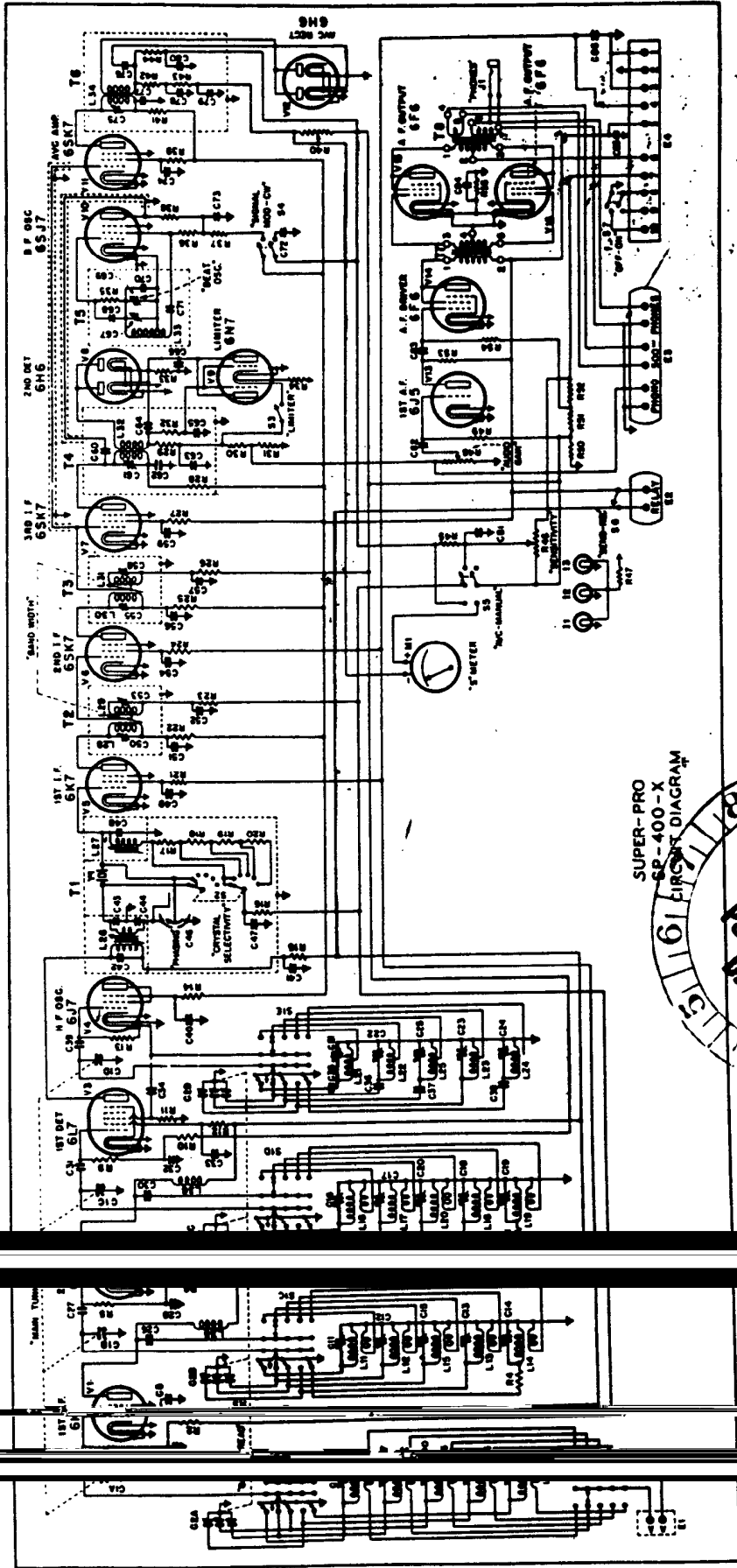

SUPER-PRO
SR-400-X
CIRCUIT DIAGRAM

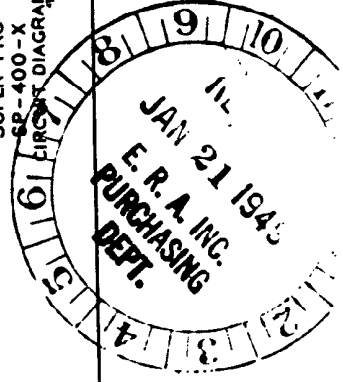

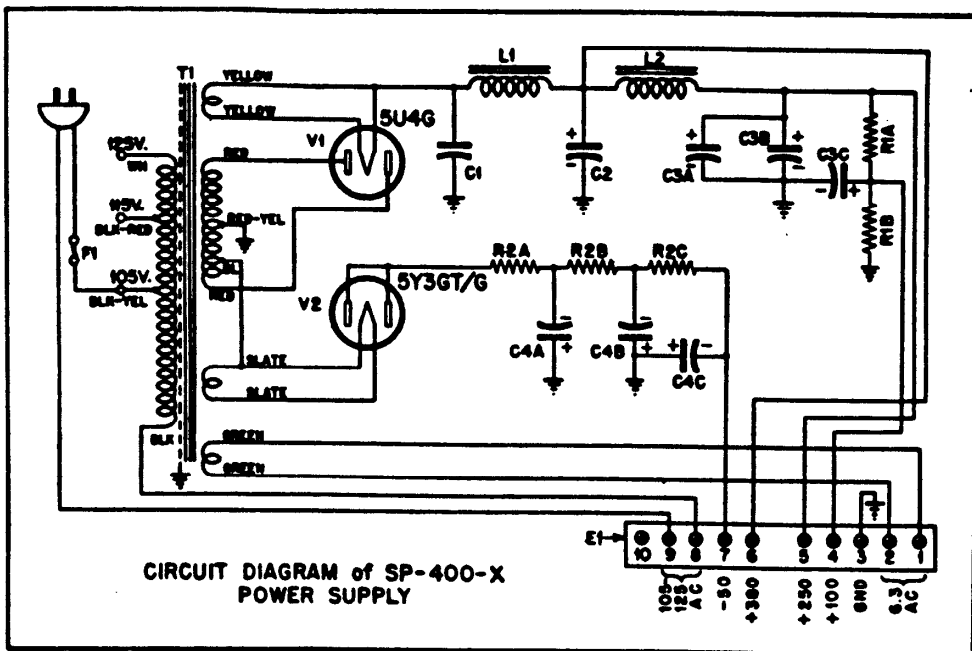

**FIG. 10—
Power supply
diagram.**