

**HQ-160
COMMUNICATIONS
RECEIVER**

**TECHNICAL
DESCRIPTION
AND
OPERATING
INSTRUCTIONS**

HAMMARLUND

The Hammarlund Manufacturing Co., Inc.
450 West 58th Street, New York 1, N. Y.

International Division, 15 East 40th Street, New York 18, N. Y.

HQ-160

COMMUNICATIONS

RECEIVER

INSTRUCTION AND SERVICE INFORMATION



ESTABLISHED 1910

In order to receive the full unconditional 90-day warranty against defective material and workmanship in this receiver, the warranty card must be filled out and mailed within two weeks of purchase. Please refer to serial number of warranty in correspondence.

THE HAMMARLUND MANUFACTURING CO., INC.
460 West 34th Street : : : : New York 1, N.Y.

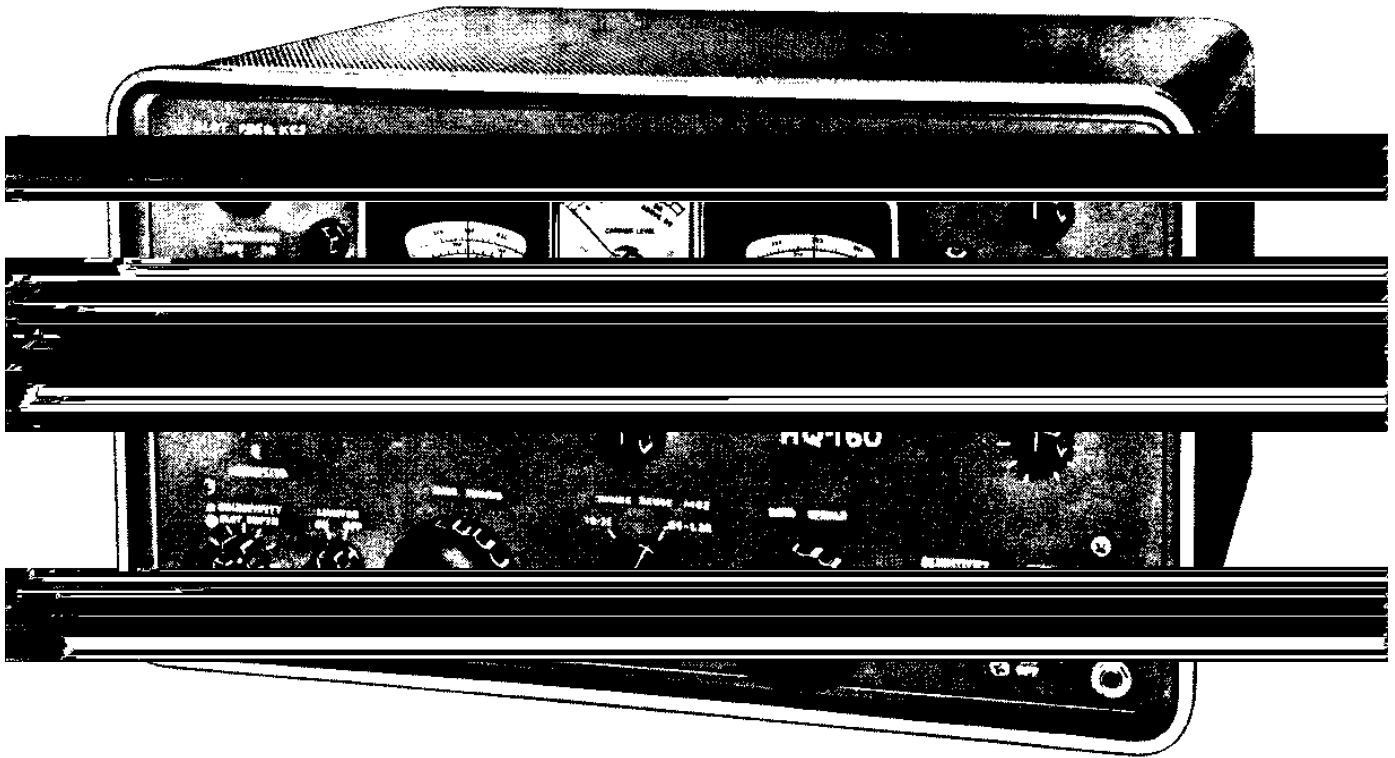

Figure 1. The HQ-160 Communications Receiver

TUBE COMPLEMENT

SYMBOL	TYPE	TUBE	FUNCTION
V1	6BA6	Pentode	R. F. Amplifier
V2	6BE6	Pentagrid Converter	Mixer
V3	6C4	Triode	H. F. Oscillator
V4	6BE6	Pentagrid Converter	Converter
V5	6BA6	Pentode	First I. F. Amplifier
V6	6BA6	Pentode	Second I. F. Amplifier
V7	6BJ7	Triple Diode	A. M. Detector—Noise Limiter—Delayed A.V.C. Rectifier
V8	6U8	Triode-Pentode	Linear Detector—B.F.O.
V9	12AX7	Twin Triode	Q—Multiplier, First A. F. Amplifier
V10	6AQ5	Beam Power Amplifier	Audio Power Output
V11	5U4GB	Twin Diode	Rectifier
V12	6BZ6	Pentode	Crystal Controlled Oscillator
V13	0B2	Gas-Filled Diode	Voltage Regulator



INTRODUCTION

The Hammarlund H.Q. 160 is the newest and finest member of the famous H.Q. series of communication receivers. Possessing the exceptional features and construction of previous H.Q.'s, its distinctive personality was developed through many new and advanced features.

The H.Q. 160 is a double conversion super-heterodyne covering the range of 540 KCS to 31 MCS. Fourteen tuned circuits in the I.F. system provide exceptional skirt selectivity with a Q-Multiplier providing the extreme selectivity and frequency control desirable for C.W. reception. A slot filter for the rejection of interfering signals reduces or eliminates QRM.

Excellent single sideband reception is assured through the use of a separate linear detector. Two separate A.V.C. circuits are used to provide optimum signal-to-noise ratio. The well known H.Q. electrical band spread and effective series noise limiter are incorporated. The Auto-Response audio circuit, which has gained such wide acceptance, is also used in the H.Q. 160.

Out-of-band operation is precluded by the built-in 100 K.C. crystal calibrator. A balanced bridge type "S" meter circuit will contribute to reliable field strength reports. A Hammarlund tuning capacitor, high Q circuits, and voltage-regulated plate supply contribute to the high oscillator stability attained.

**Standard Model H. Q. -160 Power Supply
105-125 Volts 50-60cps at approximately 100 Watts.**

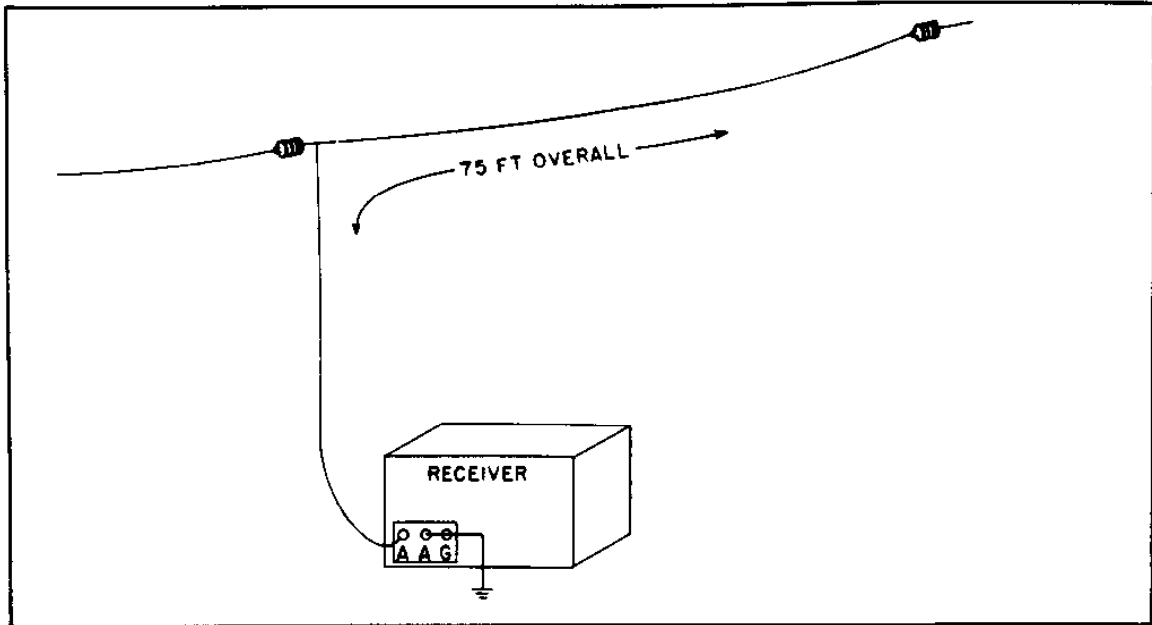

Figure 2. Installation of Single-wire Antenna

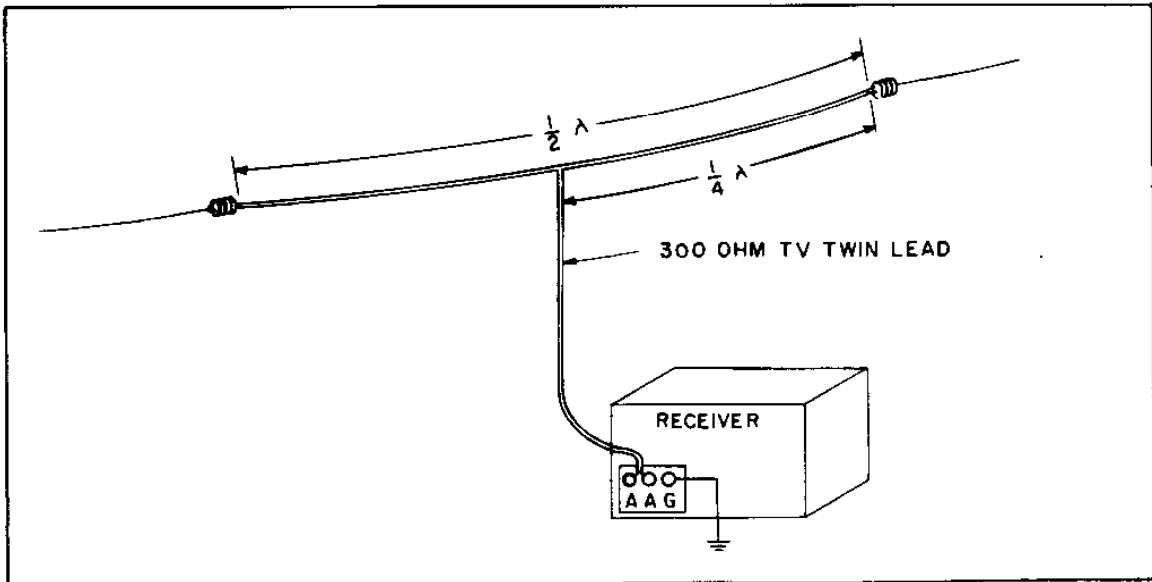

Figure 3. Installation of Folded Dipole Antenna



INSTALLATION

UNPACKING.

Unpack the receiver carefully. Make sure that tubes, tube shields and pilot lamps are in place.

SPEAKER CONNECTION.

Connect a 3.2-ohm permanent magnet dynamic speaker (Hammarlund #S100 or S200) to the two terminals marked SPKR on the rear chassis skirt. For best performance do not place speaker on top of receiver cabinet.

POWER CONNECTION.

Before inserting line cord plug into the power outlet make certain that the power source is of proper voltage and frequency.

INSTALLING ANTENNA.

The H.Q. 160 is designed for optimum performance on the short wave bands with an antenna of approximately 75 ohms impedance. For general coverage this match is not critical and excellent performance will be realized with antennae systems with impedances from 50 to 300 ohms. A good antenna for general coverage is a single wire 50 to 150 ft. long. For best results the antenna should be as high as possible. It should be isolated from neighboring objects and at right angles to power lines and busy highways to minimize interference.

Optimum performance on a particular band

Each half of the dipole (1/4 wave length) is half the length calculated from the above formula.

A good ground, although not always necessary, will generally aid in reception and reduce stray line hum. Reversal of polarity of the power cord plug may further reduce hum in some locations.

EXTERNAL RELAY CONNECTION.

A standard power receptacle is provided on the rear apron of the chassis for the connection of an external relay-operated switch. This receptacle accommodates a standard power plug and when so used the SEND-REC switch of the RECEIVER should be left in the SEND position.

The usual antenna change over relay equipped with a set of normally closed contacts is suggested. The choice of this relay will depend on the particular antenna system involved, such as whether a co-ax relay or one for open wire line is employed. In either case the extra set of contacts to control the receiver will be necessary.

HEADPHONES.

Any standard headphones may be employed. The lower the d-c resistance or impedance, the more volume will be obtained. This is due to the fact that the phones are deliberately mismatched to reduce the level applied to them, because of

one-half wave length dipole the following formula for the length of the antenna may be used:

$$\text{Length (feet)} = \frac{468}{\text{Freq. (MCS)}}$$

can be a plate-to-voice-coil output transformer used backwards. Connect the voice coil leads to the headphone plug with the plate winding connected to the phones.

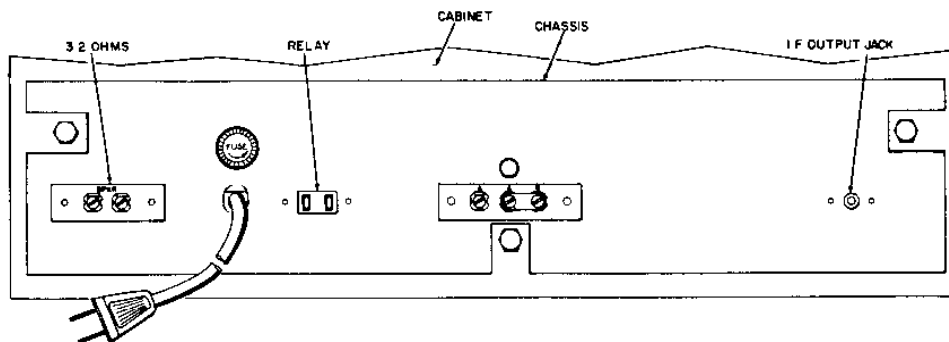
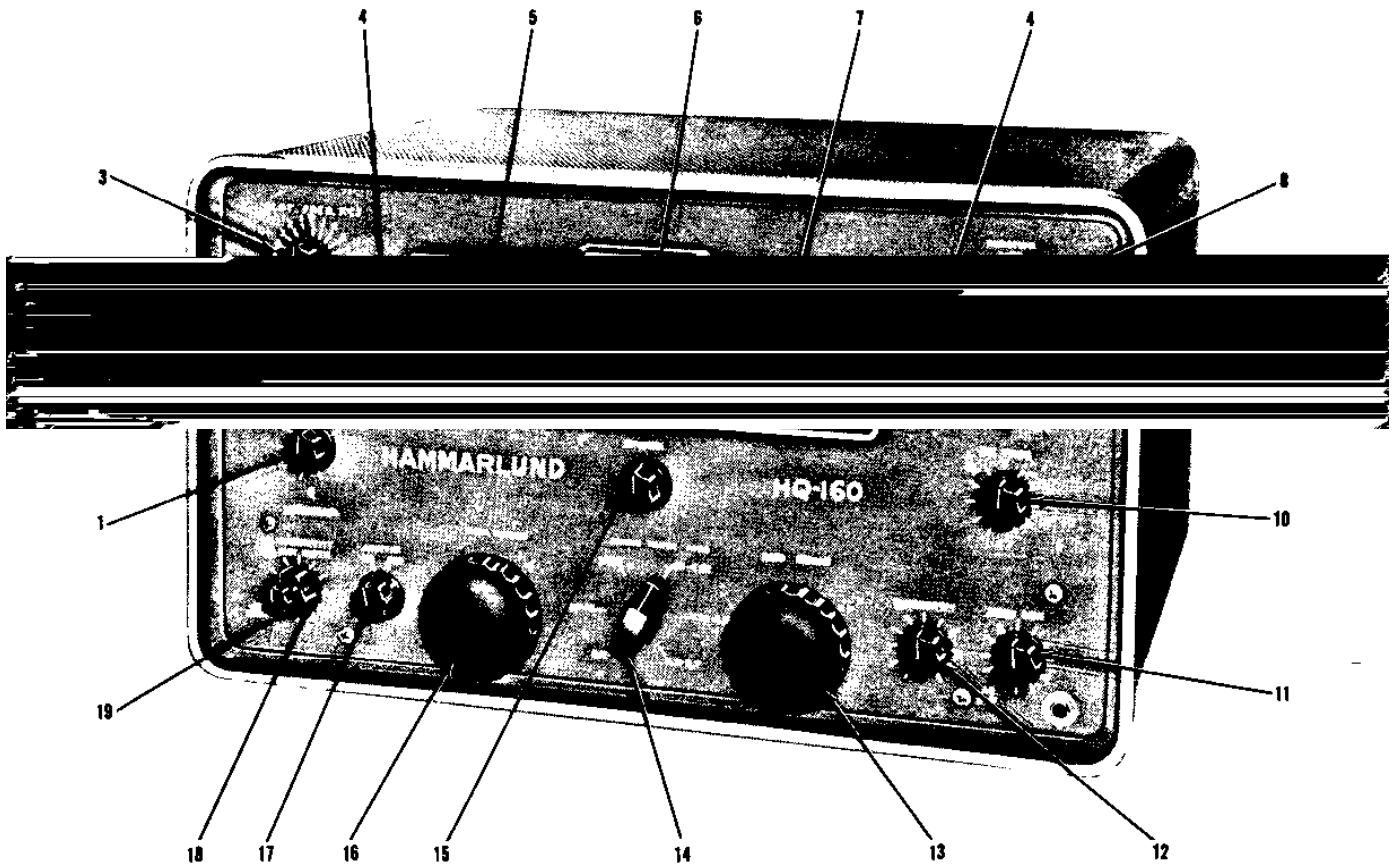

Figure 4. Connection Points at Rear of Chassis



- | | |
|------------------------------|--------------------------------------|
| 1. Q MULTIPLIER FREQ CONTROL | 11. AUDIO GAIN CONTROL |
| 2. CALIBRATOR SWITCH | 12. SENSITIVITY CONTROL |
| 3. SLOT FREQ CONTROL | 13. BAND SPREAD TUNING |
| 4. CAL SET CONTROL | 14. TUNING RANGE CONTROL |
| 5. MAIN TUNING DIAL | 15. ANTENNA CONTROL |
| 6. "S" METER CARRIER LEVEL | 16. MAIN TUNING |
| 7. BAND SPREAD DIAL | 17. LIMITER SWITCH |
| 8. FUNCTION SWITCH | 18. SLOT DEPTH CONTROL |
| 9. SEND-REC SWITCH | 19. Q MULTIPLIER SELECTIVITY CONTROL |
| 10. CW PITCH CONTROL | |

Figure 5. Location of Controls



GENERAL OPERATING INSTRUCTIONS

CALIBRATE.

To check dial calibration the FUNCTION switch is set in the CW-SSB position and the calibrator is turned on. The receiver is factory aligned with the CAL SETS on the vertical markers. The CAL SETS can be used to accurately reset the dial indicator lines if the calibration

* AUDIO GAIN—A feature of the audio system is the variable negative feedback employed. Maximum feedback is provided at low settings of the AUDIO GAIN control for best quality reception of strong signals. As the AUDIO GAIN control is increased the feedback decreases so that on reception of weak signals additional selectivity is

OPERATION

A.M. RECEPTION.

For A.M. reception the position of the controls should be as follows:

FUNCTION Switch	AVC
TUNING RANGE Switch	Set to desired frequency range
SEND-RECEIVE	RECEIVE
FREQ. CONTROL	Set pointer to triangular marker
CAL SETS	Set to vertical markers
LIMITER Switch	As required
MAIN TUNING Control	Tune for highest "S" meter reading on signal
ANTENNA Trimmer	Tune for highest "S" meter reading on signal
SELECTIVITY Control*	Fully counter-clockwise
SENSITIVITY Control*	Fully clockwise
AUDIO GAIN Control*	Adjust for required level
SLOT FREQUENCY*	As required
SLOT DEPTH*	As required

* SELECTIVITY—Normally for A.M. reception the Q Multiplier is switched off (fully counter-clockwise) for maximum bandwidth. However, the Q Multiplier may be useful in eliminating interference from adjacent signals at some sacrifice

* SLOT FREQUENCY—This control should always be in the maximum counter-clockwise or clockwise position when tuning the receiver to prevent notching out the center of the passband. Once the desired signal has been tuned in, the SLOT FREQUENCY control may be employed to reduce or eliminate adjacent channel or co-channel interference. It is also possible to eliminate heterodynes, to steepen one side of the passband curve for improved single sideband reception, or to null out a carrier for sideband reception of a normal AM signal. (Refer to page 9).

* SLOT DEPTH—The SLOT DEPTH control should be adjusted for maximum rejection. This will usually be near the 12 o'clock position. It will be found that the position of this control will not vary considerably with variations of the SLOT FREQUENCY control and it should be kept in the vicinity of maximum depth.

CODE RECEPTION.

For CW reception the position of the controls should be as follows:

FUNCTION Switch	CW-SSB
TUNING RANGE Switch	Set to desired frequency range
SEND-REC. Switch	REC.

meter calibration holds only in this condition on AVC operation. In the presence of extremely strong signals the SENSITIVITY Control may be reduced to prevent over-load.

tuning and then set either left or right for desired pitch.

MAIN TUNING Control* Tune for zero beat



ANTENNA Trimmer Tune for maximum response
 SELECTIVITY Control* "ON" and advanced as required
 SENSITIVITY Adjust for desired output level
 AUDIO GAIN At 12 to 3 o'clock
 SLOT FREQUENCY As required, see note above
 SLOT DEPTH As required, see note above

* MAIN TUNING CONTROL - For short wave reception with the MAIN TUNING dial, only - the BAND SPREAD Dial must be set to 100. To

ANTENNA Trimmer Tune for maximum response
 SELECTIVITY Control* ON, but not advanced beyond switch
 SENSITIVITY Control* As required
 AUDIO GAIN Control At 12 o'clock to 3 o'clock position
 CW PITCH Control* Set to approx 1-2 divisions (+) or (-)

* CW PITCH CONTROL - The CW Pitch Control

frequency using the crystal calibrator for highest accuracy. The amateur band tuning is then accomplished solely with the BAND SPREAD

hands so that if the upper sideband were being transmitted in one of these bands the CW Pitch Control would be set on the (+) side for best

the selectivity for rejection of adjacent signals.

* Q MULTIPLIER SELECTIVITY - The broadest position of the SELECTIVITY control (corresponding to a 6 db hand pass of 3 KC) is with the control turned clockwise just sufficiently to operate its switch. This puts the Q Multiplier in operation. Further clockwise rotation of the control narrows the bandwidth until a position is reached just short of oscillation where the bandwidth is approximately 100 cycles. The control should be adjusted below the point of oscillation

the lower sideband on these bands the CW Pitch Control is set on the (+) side or on the (-) side for best reception of the upper sideband.

There will be an optimum setting of the CW Pitch Control for each band width, once determined they should be noted for future use in SSB reception. The control will usually lie between the first and second divisions off the triangular zero beat marker.

* SENSITIVITY CONTROL - The SENSITIVITY

should be as follows:

FUNCTION Switch CW-SSB
 TUNING RANGE Switch Set to desired frequency range
 SEND-REC REC.
 FREQ. Control Set pointer to triangular marker
 CAL SETS Set to vertical markers
 LIMITER Switch OFF
 MAIN TUNING Control Tune for maximum clarity

* AUDIO GAIN CONTROL - Operating with the AUDIO GAIN as suggested will provide adequate power output while controlling gain with the SENSITIVITY control.

* SELECTIVITY CONTROL - The SELECTIVITY control should only be advanced beyond the switch "ON" position if required to increase the selectivity to eliminate interference.



CIRCUIT THEORY

The H.Q. 160 is a Dual Conversion super-heterodyne receiver covering the frequency range from 540 KCS to 31 MCS. Thirteen tubes are used under conservative ratings for long life.

PRESELECTION.

The antenna input coupling and R.F. amplifier stage provide the necessary preselection and gain for high performance and rejection of undesired signals. The high signal level at the grid of the mixer (V2) contributes to a high signal-to-noise ratio. Two tuned circuits are used ahead of the mixer on each hand.

The antenna compensating capacitor, adjustable from the front panel, permits the input to be resonated for optimum performance with the antenna used.

CONVERTER STAGES.

A high degree of oscillator stability is attained by the use of a separate mixer, V2, (6BE6) and oscillator, V3, (6 C4). The output signal from the R.F. Amplifier, V1, is combined in the mixer tube with the output of the local oscillator. On Bands 1 through 4 the difference frequency of 455 KCS is produced at the plate of the mixer. On Bands 5 and 6 the difference frequency is 3035 KCS, which is in turn injected into the converter V4 where it is mixed with a crystal-controlled oscillator at 3490 KCS to produce a difference frequency of 455 KC at the plate of V4.

I.F. AMPLIFIER.

Fourteen tuned circuits are employed in the I.F. strip to provide exceptional skirt selectivity.

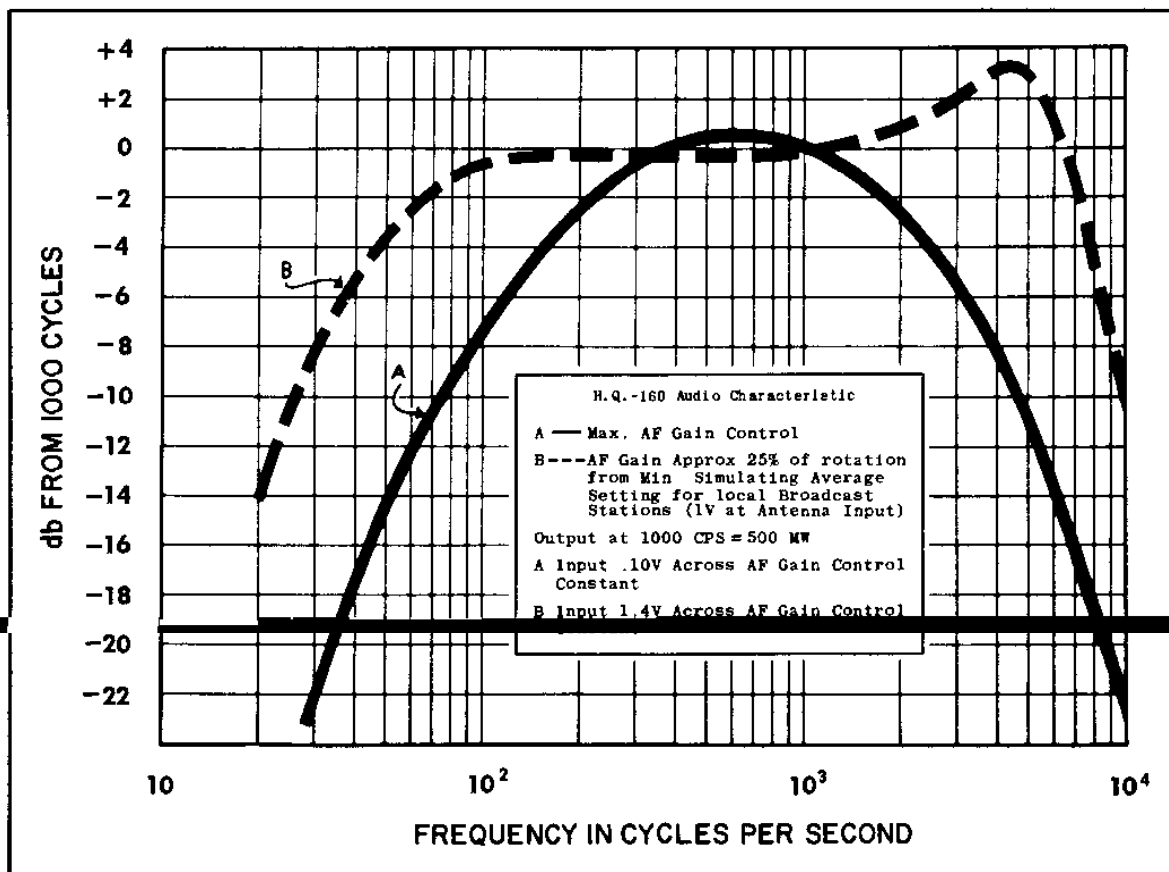

Figure 6. Auto-Response Curve



A slot filter is employed to provide a notch anywhere in the pass band for the suppression of unwanted signals. This circuit can also be used to steepen one side of the pass band for suppression of the unwanted sideband on single side band reception.

A Q Multiplier is used for controlling the Q of one of the I.F. coils for narrowing the pass band for C.W. reception. The SELECTIVITY control varies the 6 db bandwidth between 3 kcs and 100 cycle limits. The Frequency control permits the I.F. peak to be shifted across the pass band to minimize interference. The combination of the Q Multiplier and the slot filter can be used to minimize almost any type of interference caused by adjacent signals. In view of this it is suggested that some time be spent in learning how to properly adjust these controls under different receiving conditions.

NOTE

For normal reception, the SLOT FREQUENCY control should always be in the extreme clockwise or counter-clockwise position.

A.V.C. SYSTEM.

Two separate A.V.C. lines are provided for maximum efficiency. The I.F. gain is controlled by one line and the R.F. gain by a separate line. The "S" meter swing is controlled by the gain of the I.F. amplifier; consequently it is advisable for the A.V.C. on the I.F. tube to be fast acting so that the meter will respond on weak signals. Fast acting A.V.C. is not desirable on the R.F. tube as this tends to degrade the signal-to-noise ratio. Consequently the A.V.C. line for the R.F. amplifier incorporates delay.

"S" METER (CARRIER LEVEL INDICATOR).

The tuning meter is provided to assist in tuning and to provide a visual indication of the relative strength of signals. As the meter readings are proportional to AVC voltage it is operative only in the AVC position of the FUNCTION switch. The meter is factory-adjusted so that a signal of approximately 50 microvolts will give a reading of S9. Each S unit represents approximately a 6 db change in signal strength.

A.M. DETECTOR AND NOISE LIMITER.

A 6BJ7 triple diode (V7) is used to perform the functions of A.M. Detection, noise limiting and delayed AVC rectification for the R.F. amplifier.

One section of V7 is used as a low distortion detector for A.M. and for providing AVC voltage for the I.F. amplifier.

The second section operates as a self-adjusting series noise limiter. The clipping level is set at approximately 50% for maximum noise rejection; consequently some audio distortion will be experienced when the limiter is used. However, the net intelligibility due to the noise elimination will be greatly improved when the limiter is used under conditions of extreme noise.

The third section of V7 provides delayed A.V.C. voltage for the R.F. Amplifier tube.

BEAT FREQUENCY OSCILLATOR (B.F.O.).

The triode section of the 6U8 tube (V8) is used as a 455-KC oscillator for C.W. reception, and for carrier reinsertion for single sideband reception.

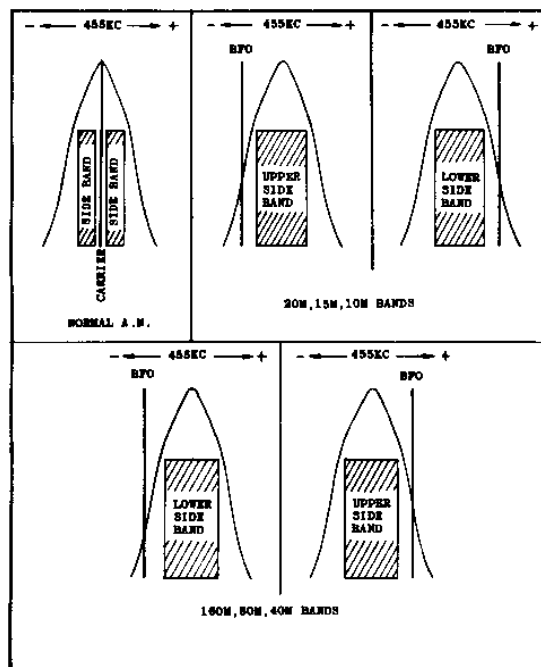

Figure 7. Relationship of the Beat Frequency Oscillator to Side Bands



A pitch control is provided for varying the audio beat on C.W., and as a vernier adjustment on S.S.B. When receiving S.S.B. the B.F.O. pitch control should be set to (+) or (-) to receive the upper or lower sideband, the exact position being determined by the selectivity used. In this instance experience is the best teacher and a little time spent in practicing the above procedures will soon result in sideband tuning becoming almost as routine as that used for A.M.

CRYSTAL CALIBRATOR.

A 6BZ6 tube (V12), a hermetically sealed quality crystal unit, and associated components form a highly stable 100-KC crystal-controlled oscillator to provide calibrating markers at 100-KC interval throughout the range of the receiver. A ceramic trimmer capacitor is provided for accurately adjusting the oscillator frequency against a primary standard such as "WWV."

LINEAR DETECTOR.

The pentode section of the 6U8 (V8) is used as a linear detector in conjunction with the B.F.O. It produces a clean clear note on C.W. reception, greater ease of tuning, and freedom from interference on S.S.B. signals.

AUDIO AMPLIFIER.

The first audio stage is half of the 12AX7 tube (V9). This is resistance-coupled to a 6AQ5 tube (V10) whose circuit arrangement provides an undistorted power output of at least one watt. Negative feedback is provided in such a manner as to be maximum at low settings of the audio gain control and minimum at high settings of the control. This results in excellent fidelity on strong signals and a narrow audio bandpass on weak signals for additional suppression of noise. (See fig. 6.)

SLOT FILTER FACTS

The slot depth control is actually a very gradual vernier adjustment. In view of this its effect will not be very noticeable unless the proper procedure is employed. The suggested procedure is as follows: Tune in a broadcast signal on the broadcast band or any other strong constant carrier of similar nature. Whenever the receiver is being tuned for normal reception be sure to first rotate the slot frequency control to the extreme clockwise or counter clockwise position. In other words, never leave the slot frequency control at or near the zero setting. If this procedure is not followed it is obvious that the center of the pass band will be slotted out, some cases this being made quite

upon approaching the zero setting, the S meter reading will be effected. A very definite null or minimum S meter reading will be obtained with the slot frequency control adjusted at or near zero. Observe this S meter reading. With the slot frequency control set at the minimum S meter reading position, the slot depth control should be rotated very slowly throughout its range, observing the S meter. It will be found that at one particular spot throughout the range of the slot depth control a further reduction in the S meter reading will be obtained. A very slight readjustment of the slot frequency may now result in a further reduction of the S meter reading. Once this setting has been



SERVICE AND ALIGNMENT PROCEDURE

ALIGNMENT GENERAL.

NOTE

Before servicing this receiver, disconnect it from the power source and remove all leadwires attached to the terminal connections at the rear of the chassis apron. Carefully turn the receiver up onto the front panel face on a smooth clean surface. At the rear of the cabinet, remove the three No. 10 hex machine screws at the ends and center of the chassis apron. Lift the cabinet straight up and off the chassis. To reassemble, use the reverse procedure.

NOTE

Use a non-metallic alignment tool such as General Cement Co. (No. 5097) or equal, for transformers T3 to T8 inclusive. Use a non-metallic alignment tool such as General Cement Co. (No. 5097) or equal, for transformers T1 and T2 and for the slug adjustment of L3. A thin blade alignment screwdriver should be used for RF and HF oscillator slug and trimmer adjustments. All adjustments have been carefully made at the factory and should require only a minimum amount of adjustment for any realignment.

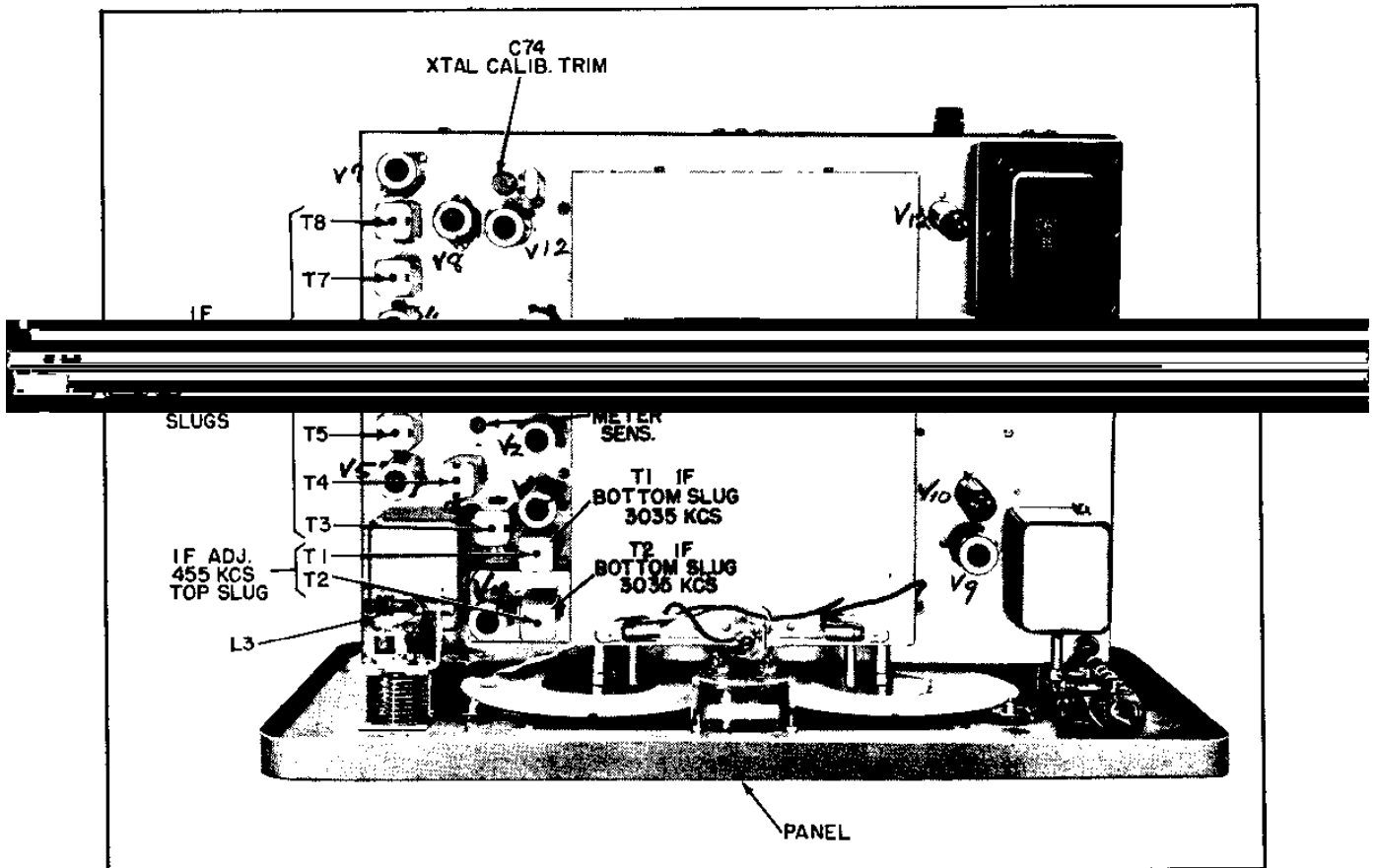

Figure 8. Top View of Chassis



I.F. ALIGNMENT.

a. Connect the output cable of a 455 KCS unmodulated signal generator to the V2 mixer grid (6BE6), and the shield of the generator cable to the chassis. The frequency accuracy of the generator may be checked by picking up its second harmonic (910 KCS) in any receiver whose calibration at 910 KCS has been checked as correct.

b. Connect a d-c VTVM set for negative voltage reading to the junction of C47, and terminal No. 5 of Z2 and the shield of the VTVM to the chassis. *TP1*

c. Set the receiver controls as follows:

FUNCTION Switch	MAN
TUNING RANGE Switch	.54 to 1.32 MCS
SEND—REC	REC.
FREQ. Control	To be adjusted later
CAL SETS	To vertical markers
LIMITER Switch	OFF
MAIN TUNING Control	Set to 550 KCS
ANTENNA Trimmer	Not applicable
SELECTIVITY Control	To be adjusted
SENSITIVITY Control	Adjust to prevent overload
AUDIO GAIN	Minimum
SLOT FREQUENCY	Set to upper 5. Slug, in L3, is run out to the end of coil form.
SLOT DEPTH	To be adjusted. Temporarily set to 12 o'clock position.

d. During alignment adjust the generator output and the SENSITIVITY control to prevent overloading. Final adjustments should be made with the SENSITIVITY control approximately 3 indices from its maximum (clockwise) position. Adjust the top and bottom slugs in transformers T3 to T7 inclusive, and the upper slugs of T1 and T2 for maximum amplitude of VTVM. Connect the VTVM to pin 2 of V8, and adjust the top and bottom slugs of T8 for maximum meter reading. *TP2*

e. After initial alignment of these transformers the SLOT FREQUENCY is set to zero and the slug in L3 is adjusted alternately with the SLOT DEPTH control for minimum reading of the VTVM. The SLOT DEPTH position will only vary slightly from this position in operation. Reset the SLOT FREQUENCY control to "Upper 5" and re-

check adjustment of T3 and T4 for maximum VTVM reading.

f. Turn the Q Multiplier SELECTIVITY control clockwise to a position below the oscillating point. With its collar setscrews loosened to permit the frequency shaft to turn without hindrance by the stop, adjust the Frequency Control for maximum meter reading, this is the center frequency of the pass band. While the meter is at maximum turn the collar so that the long set screw is in a position 180 degrees directly opposite the stop lug. Holding it in this position, tighten the set screws, making sure that the shaft has not turned, by checking the zero setting. If necessary adjust the knob to the zero marker.

g. Turn the FUNCTION Switch to CW—SSB and with the CW PITCH control stop collar setscrews loosened, adjust the CW PITCH control for zero beat. While in zero beat condition tighten the collar set screws with long screw 180° opposite stop lug. Adjust the knob if necessary to the zero marker.

h. Turn the FUNCTION Switch to Receive, the TUNING RANGE switch to 10-18 MCS, and other controls as listed under paragraph c. Tune the signal generator to approximately 3035 KCS for a maximum VTVM reading. Adjust the bottom slugs of T1 and T2 for maximum VTVM reading. The bottom slug in T2 is adjusted from the top of the shield can. Be careful when passing the tool through the top slug, so as not to disturb its adjustment.

R.F. ALIGNMENT.

a. The controls are set as per paragraph c for I.F. alignment and the VTVM is connected as per paragraph b. The unmodulated signal generator is connected to the antenna terminals of the receiver, with the high lead of the output cable, through a series resistor equal to approximately 100 ohms, (minus the output impedance of the generator), to the A terminal furthest from the G terminal, and the ground or shield lead of the cable connected to the jumped A and G terminals. The G terminal should preferably be connected to ground.

b. Each band is adjusted for maximum VTVM reading by changing the inductance at the low-



frequency end, and the capacitance at the high-frequency end. These adjustments mutually affect each other and should be repeated until the dial calibration coincides with frequency at both ends of the band. Maximum output deflection is obtained at both ends of the band without further adjustment of the R.F. coils or trimmer (excepting only the ANTENNA trimmer).

c. As shown on the Chart (fig. 9), the front row of adjustments control the H.F. oscillator frequency and consequently the dial calibration. The middle row of adjustments control R.F. alignment, and the rear adjustments are for antenna alignment of the two lower frequency bands. These two antenna coils should be adjusted at the low frequency ends of the two bands with the antenna trimmer set at mid range. The TUNING RANGE switch is turned to the proper position for each band as required.

d. The H.F. oscillator is on the high side of the signal frequency on all bands. The trimmer adjustments should be the final adjustments at the upper frequency for each band.

e. The METER ZERO pot is adjusted with mixer grid grounded (Pin 7, V2). The METER SENS pot is adjusted for S9 with 50 microvolts input at 4.5 MC.

CALIBRATOR.

Tune in a standard frequency signal, preferably WWV at 5 MCS, tuning for maximum meter read-

ing on AVC. Turn the CALIBRATOR switch to ON and carefully adjust the trimmer capacitor on the crystal calibrator for zero beat with the standard signal. To use the calibrator, switch to CW-SSB and check the dial calibration for zero beat at the nearest 100 KCS point to the desired frequency. If necessary adjust the calibration reset knob to set the window line exactly on this 100 KCS point.

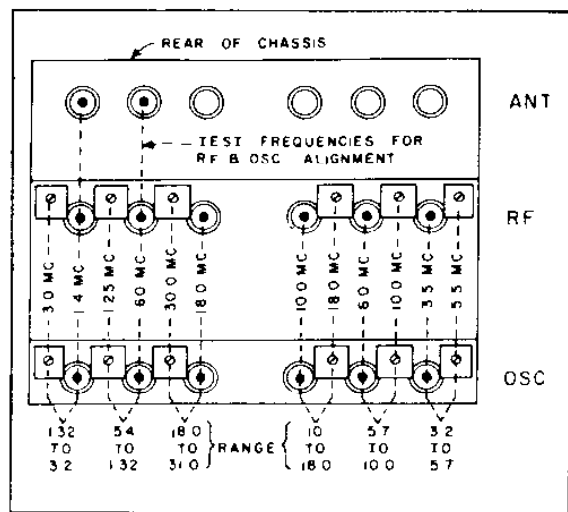

Figure 9. Antenna RF and Oscillator Tuning Diagram

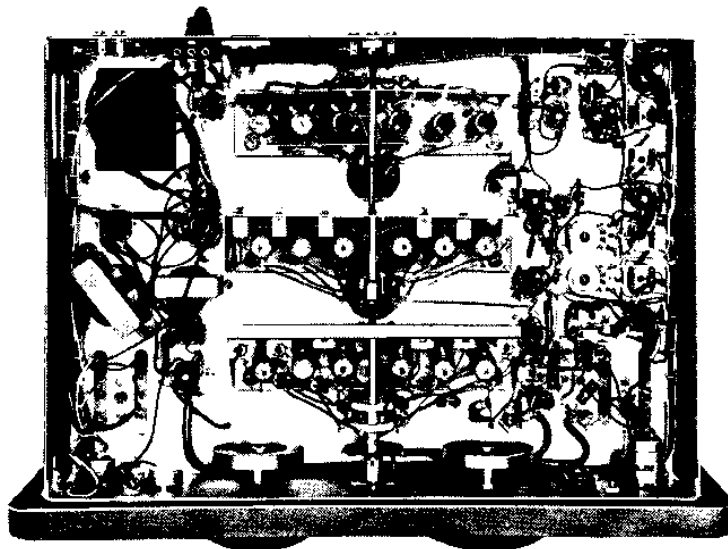

Figure 10. Bottom View of Chassis

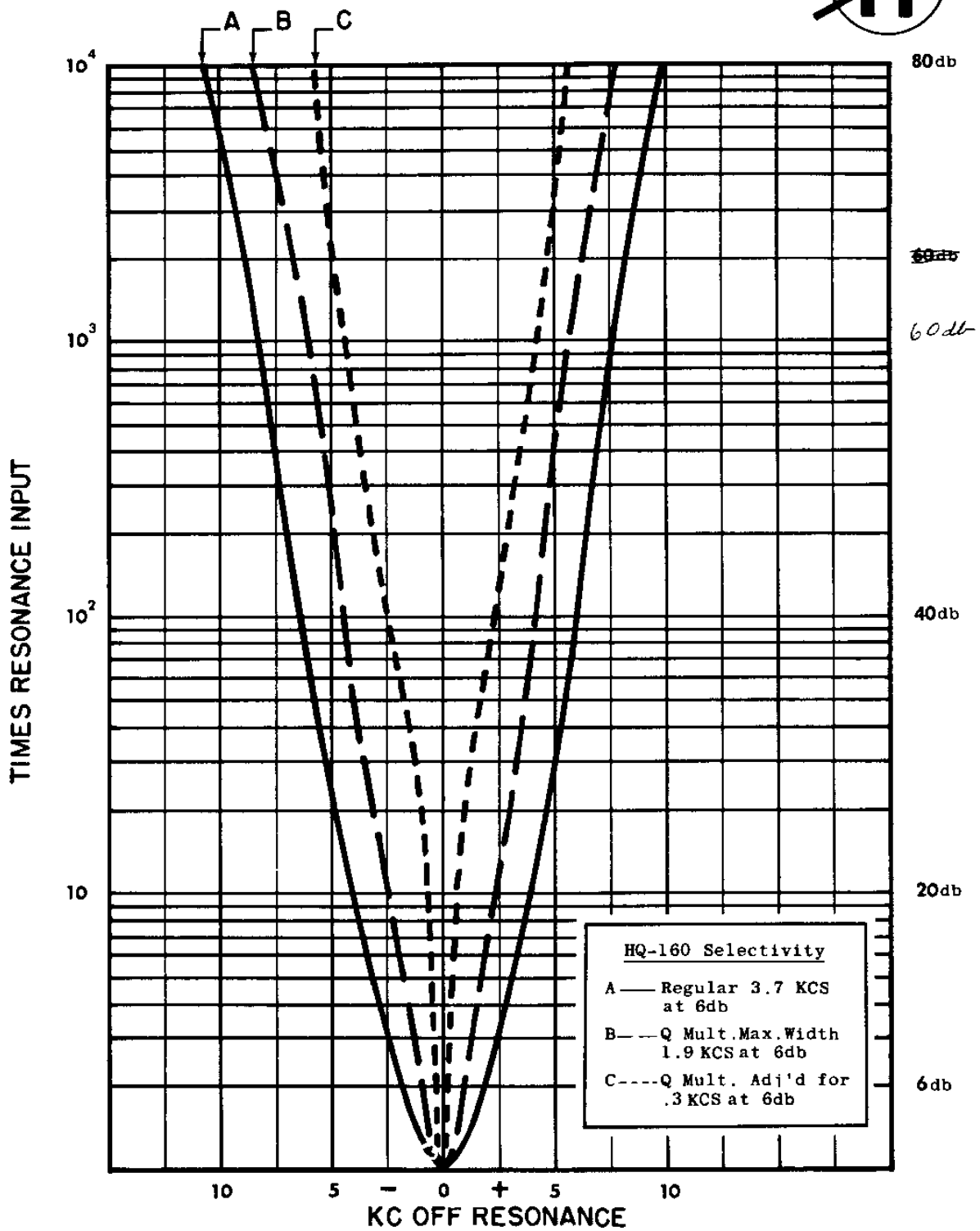

Figure 11. Selectivity Curves



MAINTENANCE

The H.Q. 160 is designed to give years of trouble-free service. Tube failure is the most common source of trouble. The second most common cause of difficulty is component failure among small resistors and fixed capacitors.

The following charts give voltages and resistances between tube socket terminals and chassis. Voltages indicated are those measured with a vacuum tube voltmeter; resistances with a vacuum tube ohmmeter. Slight variations in the order of 10 per cent from indicated values should be disregarded.

With the aid of the chart and schematic diagram, components can usually be located. The parts listing in the back pages of this manual gives component values and Hammarlund part numbers.

Standard items may be purchased locally, non-standard components are available on order from the factory.

A sensitive communications receiver should be entrusted only to a qualified technician. Should difficulty be experienced, please write Hammarlund Manufacturing Company for advice or to arrange for factory service.

SOCKET VOLTAGE TABLE

Measured with VT Voltmeter - Voltages to chassis; send-rec on Rec; Audio Gain Max; Sensitivity Max., except where otherwise specified, Limiter On; Function SW on SSB-CW; Q Multiplier Selectivity On but at Counterclockwise position. Values are approximately plus or minus 10%, Cal. Switch On. Range Switch On 10 - 18 MC. Line Voltage 117. V 100 Watts.

TUBE SOCKET	SOCKET PIN NUMBERS								
	1	2	3	4	5	6	7	8	9
V1 6BA6 RF			6.3 AC		165	95.	1.2 24 Min. Sens		
V2 6BE6 MIXER	-2.8	1.3	6.3 AC		180	90.			
V3 6C4 HF OSC			6.3 AC		100.	-4.4			
V4 6BE6 CONVERTER	-1.5 Adapter		6.3 AC		180. Adapter	82.			
V5 6BA6 1st IF AMP			6.3 AC		170	100.	2.2 24. Min Sens		
V6 6BA6 2nd IF AMP			6.3 AC		170.	105	2.8 24. Min. Sens		
V7 6BJ7 DET-LIM-AVC				5.0 AC		-65	2.5	-1.8	-1.4
V8 6U8 BFO-SSB-CW DET	100.	2.4 AC	108.	6.3 AC		165	.68		3.4 AC
V9 12AX7 AF AMP-Q MULT	185.		2.0	6.3 AC	6.3 AC	70.		6	
V10 6AQ5 OUTPUT		16.	6.3 AC		290	265.			
V11 5U4-GB RECT.		300.	265.	265 AC	6.3 AC	265. AC		300.	
V12 6BZ6 CAL.	-40.	7.2		6.3 AC	105.	62.	7.2		
V13 OB2 REGULATOR	105				105				





SOCKET RESISTANCE TABLE

Measured with VT Volt-Ohmmeter - Resistance to chassis; Send-Rec on Rec; Audio Gain Min - Off Sensitivity Max, except where otherwise specified; Limiter On; Function SW on SSB-CW; Q Multiplier Selectivity On but at counterclockwise position. Values are approximately plus or minus 10%. Cal Switch On. Note: Temporarily ground Red + B, 200V, when making resistance measurements only.

TUBE SOCKET	SOCKET PIN NUMBERS								
	1	2	3	4	5	6	7	8	9
V1 6BA6 RF	480.K	0		0	2.2K	5.2K	68. 10K Sens. Min.		
V2 6BE6 MIXER	22 K	150		0	2.2K	5.2K			
V3 6C4 HF OSC				0	5.2K	47.K	0		
V4 6BE6 CONVERTER	22.K	0		0	2.2K	27.K	1.5		
V5 6BA6 1st IF AMP	10.	0	0		2.2K	3.K	180 10K Sens. Min.		
V6 6BA6 2nd IF AMP	8	0	0		2.2K	5.2K	300 10K Sens. Min.		
V7 6BJ7 DET-LIM-AVC	0	170.K		3.3	0	340.K	4.7K	2.2 MEG	2. MEG
V8 6U8 BFO-SSB-CW DET	47.K	220.K	33.K		0	4.7K	100.	0	2.2 MEG
V9 12AX7 AF AMP-Q MULT	10.K	2.2 MEG	17.K 7.K Max. Select.			500.K	47 to 200	2.2K	0
V10 6AQ5 OUTPUT	500 K	430.		0	1.6K	1 K			
V11 504-GB RECT.		1.4K	1 K	740.		740.		1.4K	
V12 6BZ6 CAL.	470.K	4.7K	0		470.K	100.K	4.7K		
V13 OB2 REGULATOR	3 K				3K		0		



PARTS LIST HQ-160

SCHEMATIC DESIGNATION	DESCRIPTION	HAMMARLUND PART NO.
CAPACITORS		
C1, A-F	Main Tuning..... (Part of 20840-G4)	
C2, A-I	Band Spread Tuning..... (Part of 20840-G4)	
C3	Antenna Tuning..... (Part of 20840-4)	
C4	Dur-Mica, DM-15 100 mmf 500 W.V.D.C.	23006-1
C5	Ceramic Disc, .04 mfd 600 W.V.D.C.	23034-12
C6, 7, 8	Ceramic Disc, .01 mfd 600 W.V.D.C.	23034-19
C9	Dur-Mica, DM-19 510 mmf 500 W.V.D.C.	23027-3
C10, 11	Ceramic, temperature compensating 47 mmf N-750	23061-26J
C12, 13, 14	Ceramic Disc, .01 mfd 600 W.V.D.C.	23034-19
C15	Dur-Mica, DM-15 20 mmf \pm .5 mmf 500 W.V.D.C.	23006-17
C16	Dur-Mica, DM-19 560 mmf 500 W.V.D.C.	23027-6
C17, 18	Ceramic Disc, .01 mfd 600 W.V.D.C.	23034-19
C19, 20	Ceramic Disc, .01 mfd 10% 1000 W.V.D.C.	23034-25
C21	Fixed Dur-Mica, DM-19 1200 mmf 500 W.V.D.C.	23027-4
C22	Paper, Mylar .033 mfd 200 W.V.D.C.	23044-1
C23	Variable, 54 mmf	42041-1
C24	Dur-Mica, DM-19 1100 mmf 500 W.V.D.C.	23027-2
C25	Dur-Mica, DM-20 3300 mmf W.V.D.C.	23041-2
C26	Dur-Mica, DM-19 510 mmf 500 W.V.D.C.	23027-3
C27	Ceramic Disc, .01 mfd 600 W.V.D.C.	23034-19
C28	Ceramic Disc, .04 mfd 600 W.V.D.C.	23034-12
C29, 30	Ceramic Disc, .01 mfd 600 W.V.D.C.	23034-19
C31	Ceramic Disc, .04 mfd 600 W.V.D.C.	23034-12
C32	Dur-Mica, DM-15 7 mmf \pm .5 mmf 500 W.V.D.C.	23006-24
C33	Ceramic Disc, .04 mfd 600 W.V.D.C.	23034-12
C34, 35	Ceramic Disc, .01 mfd 600 W.V.D.C.	23034-19
C36, 37	Dur-Mica, DM 30-4300 mmf 500 W.V.D.C.	23042-2
C38	Dur-Mica, DM-19 510 mmf 500 W.V.D.C.	23027-3
C39	Ceramic, temperature compensating 47 mmf N-750	23061-26J
C40, 41	Ceramic Disc, .01 mfd 600 W.V.D.C.	23034-19
C42, 43	Ceramic Disc, 1000 mmf 1000 W.V.D.C.	23034-20
C44	Ceramic Disc, .01 mfd 600 W.V.D.C.	23034-19
C45	Dur-Mica, DM-15 7 mmf \pm .5 mmf 500 W.V.D.C.	23006-24
C46	Dur-Mica, DM-15 15 mmf 300 W.V.D.C.	23006-35
C47	Ceramic Disc, .01 mfd 600 W.V.D.C.	23034-19
C48	Ceramic Disc, .005 mfd 1000 W.V.D.C.	23034-10
C49, A, B, C, D	Electrolytic, A, 40-450V, B, 20-450V, C, 40-450V, D, 25-50V	23089-1
C50	Dur-Mica, 15 mmf 300 W.V.D.C.	23006-35
C51	Dur-Mica, 7 mmf 500 W.V.D.C.	23006-24
C52	Ceramic Disc, .01 mfd 600 W.V.D.C.	23034-19
C53	Dur-Mica, 300 mmf \pm 2% 300 W.V.D.C.	23027-7
C54	Dur-Mica, 673 mmf \pm 1% 300 W.V.D.C.	23027-8
C55	Dur-Mica, 1000 mmf \pm 5% 300 W.V.D.C.	23027-9
C56	Dur-Mica, 1500 mmf \pm 5% 300 W.V.D.C.	23027-10
C57	Dur-Mica, 550 mmf \pm 2% 300 W.V.D.C.	23027-11
C58	Dur-Mica, 1055 mmf \pm 2% 300 W.V.D.C.	23027-12
C59, 60, 64	Trimmer Assembly, 1-8 mmf	23008-1
C61, 62, 63	Trimmer, 3-12 mmf	23059-2
C65, 66, 67, 68, 69, 70	Trimmer	23043-7
C71	Ceramic Disc, .01 mfd 10% 1000 W.V.D.C.	23034-25
C72, 73	Ceramic Disc, .01 mfd 1400 W.V.D.C.	23034-26
C74	Variable, 8-50 mmf	23038-5
C75, 76	Dur-Mica, DM-15 5 mmf 10% 500 W.V.D.C.	23006-5
C77	Ceramic Disc, .01 mfd 600 W.V.D.C.	23034-19
C78	Ceramic Disc, 330 mmf \pm 5% 500 W.V.D.C.	23010-9
C79	Dur-Mica, DM-15 33 mmf \pm 2% 300 W.V.D.C.	23006-34
C80	Dur-Mica, DM-19 510 mmf 500 W.V.D.C.	23027-3
C82	Ceramic-Dielectric, temperature compensating N-750, 1.5 mmf \pm .25 mmf	23061-4B
C83	Dur-Mica, 5 mmf 500 W.V.D.C.	23006-5
C85	Dur-Mica, DM-19 1200 mmf 500 W.V.D.C.	23027-13
C86	Ceramic Temp. Comp. 130-N750	23063-92E
C87	Dur-Mica, DM-15 3 mmf 300 W.V.D.C.	23006-18
E1	Antenna Terminal Strip	42030-1



SCHEMATIC DESIGNATION	DESCRIPTION	HAMMARLUND PART NO.
MISCELLANEOUS		
E2	Output Terminal Strip (Speaker)	42029-1
F1	Fuse, 2 ampere type 3 AG	15928-7
J1	Phone Jack	35608-1
J2	Power Outlet, (Relay)	35013-1
J3	Jack, sideband selector	42123-1
I1,2,3	Pilot Lamp No. 47, 6.3V .15 ampere	16004-1
COILS		
L1	R.F. Choke, 192 microhenrys	38971-1
L2	Bifilar Coil	42032-1
L3	Slot Frequency Inductance Assembly	42034-1
L4	Coil & Ferrule Assembly	26215-G2
L5	R.F. Choke, 2 millihenrys	15628-1
L6	Filter Reactor, 8 HY 375 ohms	38939-1
L7	Coil & Ferrule Assembly	38989-G1
L8	Antenna Coil Assembly, .54 - 1.32 mc range	26051-G1
L9	Antenna Coil Assembly, 1.32 - 3.2 mc range	26051-G3
L10	Antenna Coil, 3.2 - 5.7 mc range	6013-1
L11	Antenna Coil, 5.7 - 10 mc range	6016-1
L12	Antenna Coil, 10 - 18 mc range	6019-1
L13	Antenna Coil, 18 - 31 mc range	6022-1
L14	R.F. Coil Assembly, .54 - 1.32 mc range	26204-G2
L15	R.F. Coil Assembly, 1.32 - 3.2 mc range	26204-G1
L16	R.F. Coil Assembly, 3.2 - 5.7 mc range	26204-G3
L17	R.F. Coil Assembly, 5.7 - 10 mc range	26047-G5
L18	R.F. Coil Assembly, 10 - 18 mc range	26047-G4
L19	R.F. Coil Assembly, 18 - 31 mc range	26047-G3
	R.F. Coil Assembly, .54 - 1.32 mc range	26203-G2

R1	22 Ohms, 1/2 W	19309-9
R2	68 Ohms, 1/2 W	19309-21
R3	10,000 Ohms, 1/2 W	19309-73
	10,000 Ohms, 1/2 W	19309-113

R12	2,200 Ohms, 1/2 W	19309-81
R13	22,000 Ohms, 1/2 ±10%	19309-81
R14	2,200 Ohms, 1/2 W	19309-57
R15	39 Ohms, 1/2 W	19309-253
R16	Variable 200 Ohms, slot filter	38976-1
R17	Variable 10,000 Ohms.....(Part of R16)	
R18	4300 Ohms, 1/2 W	19309-213
R19	2.2 Meg Ohms, 1/2 W	19309-129
R20	68 Ohms, 1/2 W	19309-256
R21	100 Ohms, 1/2 W	19309-25
R22	180 Ohms, 1/2 W	19309-260
R23	Variable 10,000 Ohms	26218-5
R24	100,000 Ohms 1W	19310-97
R25	2,200 Ohms, 1/2 W	19309-57
R26	1,000 Ohms 1/2 W	19309-49



PARTS LIST HQ-160 (Cont'd)

SCHEMATIC DESIGNATION	DESCRIPTION	HAMMARLUND PART NO.
RESISTORS(Cont'd)		
R27	Variable 1,500 Ohms, meter adj.	15379-2
R28	Variable 300 Ohms, meter adj.	15379-1
R29	27,000 Ohms, 2 W	19304-52
R30	47,000 Ohms, 1/2 W	19309-89
R31	2.2 Meg Ohms, 1/2 W	19309-129
R33, 34	2,200 Ohms, 1/2 W	19309-57
R35	220,000 Ohms, 1/2 W	19309-105
R36	100 Ohms, 1/2 W	19309-25
R37	33,000 Ohms, 1/2 W	19309-85
R38	4,700 Ohms, 1/2 W	19309-65
R39	2.2 Meg Ohms, 1/2 W	19309-129
R40	2,200 Ohms, 1/2 W	19309-57
R41	Variable 1 Meg Ohms, audio gain	38977-1
R42	430 Ohms, 1 W	19310-212
R43	100 Ohms, 1/2 W	19309-25
R44	47 Ohms, 1/2 W	19309-17
R45	1,000 Ohms, 15 W	19330-3
R46	3,000 Ohms, 10 W	19330-6
R47	10 Ohms, 1/2 W	19309-1
R48	2,200 Ohms, 1/2 W	19309-57
R49	22 Ohms, 1/2 W	19309-9
R50	10,000 Ohms, 1/2 W	19309-73
R51	2.2 Ohms, 1 W	19309-57
TRANSFORMERS AND IMPEDANCE ASSEMBLIES		
S1-CH, F	R.F. Plate	6063-1
S1-DR, F	Detector Grid Tap	6064-1
S1-ER, F	H.F. Osc. Grid	6332-1
S1-FR, F	H.F. Osc. Plate	6331-1
S1-GR, F	Conversion	38974-1
S2	Switch, rotary cal.	6098-1
S3	Switch, Q multiplier off-on.....(Part of R17)	
S4	Switch, limiter	6098-2
S5	Switch, stand-by rec	6098-1
S6	Switch, rotary function	38975-1
S7	Switch, power off-on.....(Part of R41,38977-1)	
T1, 2	I.F. Transformer, 3035 & 455 kc	38985-1
T3	I.F. Transformer, 455 kc	38990-1
T4	I.F. Transformer, 455 kc	38946-1
T5, 6, 7	I.F. Transformer, 455 kc	38829-2
T8	I.F. Transformer, 455 kc	38946-1
T9	Output Transformer	38828-1
T10	Power Transformer, 50 - 60 cycle 117V	26109-2
T10(Alt.)	Power Transformer, 105, 115, 125, 140, 220 & 250v. 25 - 60 cycle	26188-2
Y1	Crystal, 3.49 mc	38972-1
Y2	Crystal, 100 kc	38661-1
Z1	RC Network, audio	38846-1
Z2	RC Network, det-lim	38885-1
Z3	RC Network, avc-delay	38980-1
Z4	RC Network, calibrator	38981-1

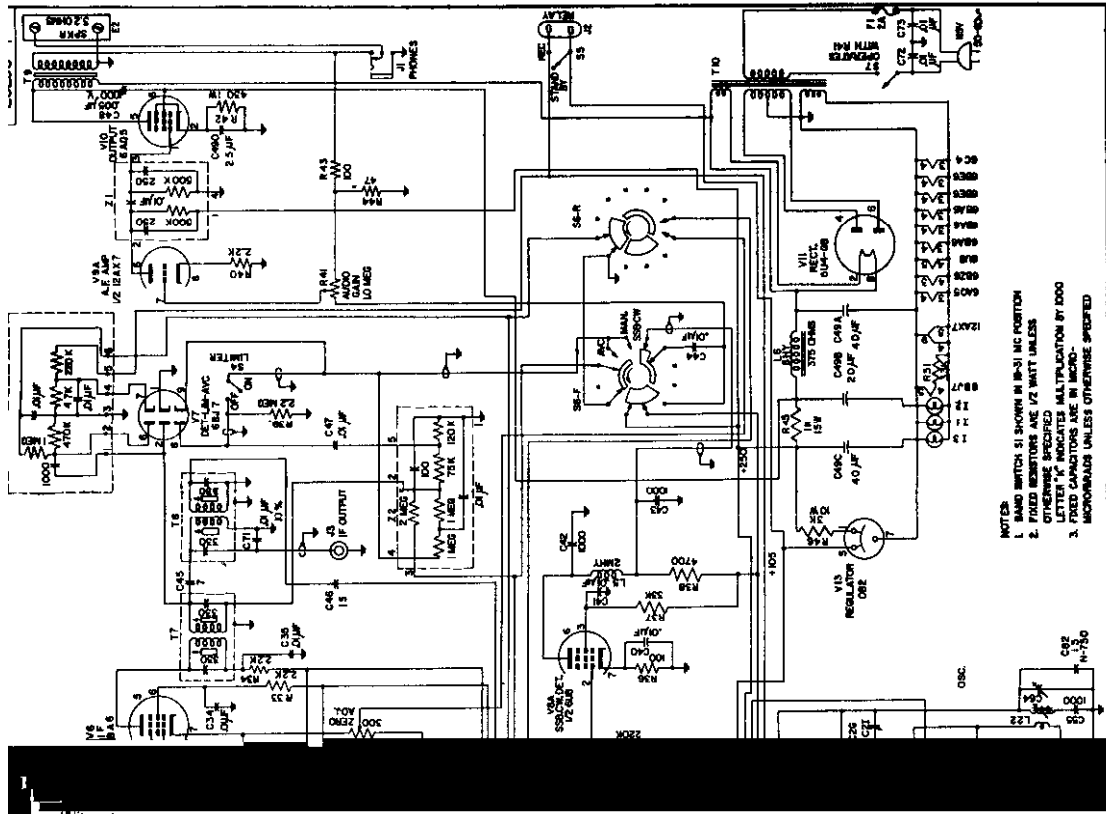

- NOTES:
 1. MAIN SWITCH IS SHOWN IN 8-31 MC POSITION
 2. FIXED RESISTORS ARE 1/2 WATT UNLESS OTHERWISE SPECIFIED
 LETTER "K" INDICATES MULTIPLICATION BY 1000
 3. FIXED CAPACITORS ARE IN MICRO-MICROFARADS UNLESS OTHERWISE SPECIFIED

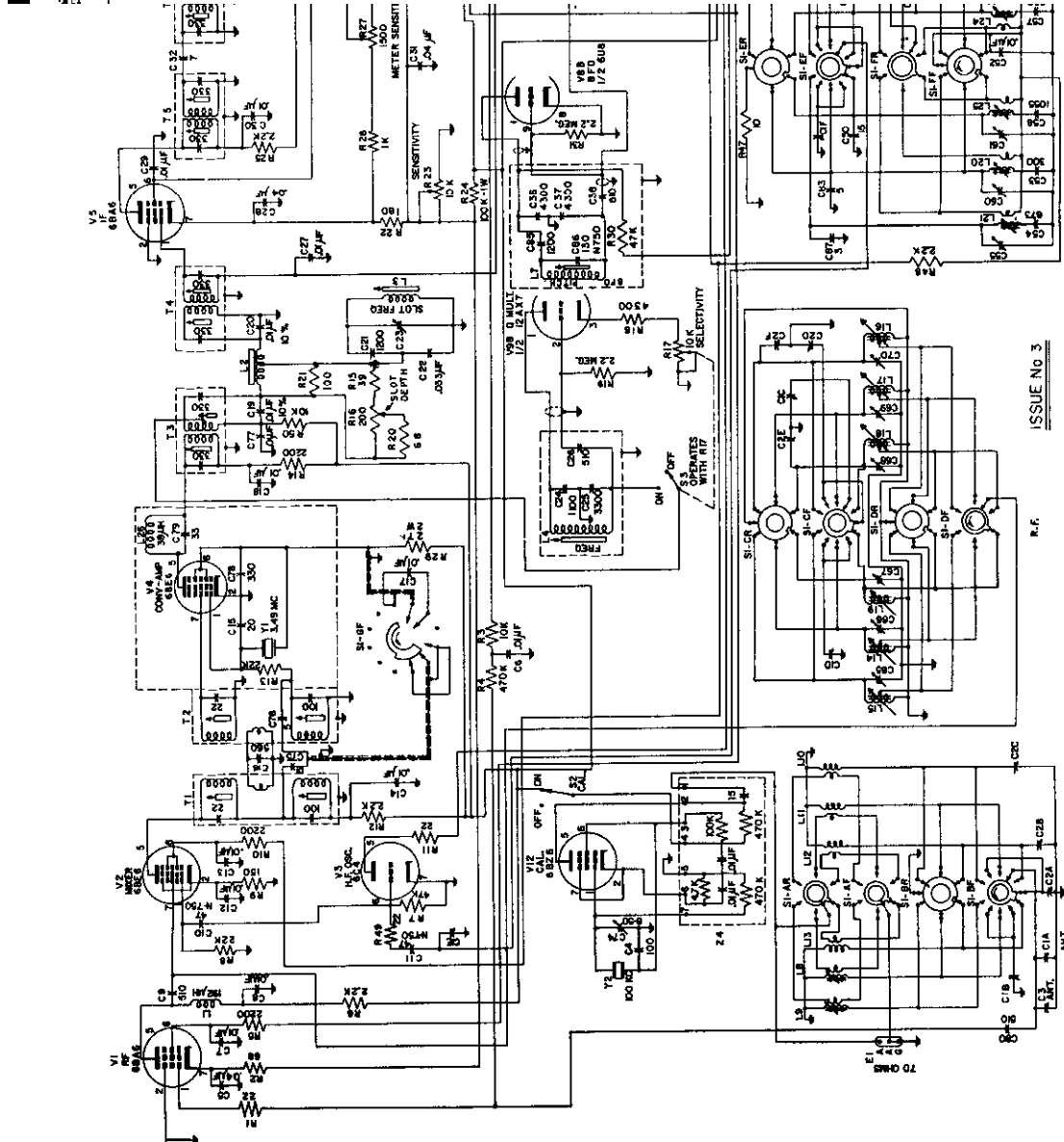

ISSUE NO 3

12. Hammarlund HQ-160 Communications Receiver, Schematic Diagram

THE HAMMARLUND MANUFACTURING COMPANY, INC.

Standard Warranty

The Hammarlund Manufacturing Company, Inc., warrants this equipment to be free from defects in workmanship and materials under normal and proper use and service for the uses and purposes for which it is designed, and agrees to repair or replace, without charge, all parts thereof showing such defects which are returned for inspection to the Company's factory, transportation prepaid, within a period of 90 days from date of delivery, provided such inspection discloses to the satisfaction of the Company that the defects are as claimed, and provided also, that the equipment has not been altered, repaired, subjected to misuse, negligence or accident, or damaged by lightning, excessive current or otherwise, or had its serial number or any part thereof altered, defaced, or removed. Tubes shall be deemed to be covered by the manufacturer's standard warranty applicable thereto, and such items shall be and are hereby excluded from the provisions of this warranty. Pilot lamps and fuses are not guaranteed for length of service.

Except as herein specifically provided, no warranty, express or implied, other than that of title, shall apply to any equipment sold hereunder. In no event shall the Company be liable for damages by reason of the failure of the equipment to function properly or for any consequential damages.

This Warranty is valid for the original owner of the equipment, and is contingent upon receipt of the Warranty Registration Card by the Company. No equipment shall be returned to the factory for repairs under warranty unless written authorization is obtained by the Company, and the equipment is shipped prepaid by the owner. The Company maintains Authorized Service Stations, names and locations of which will be sent upon request of the owner.

The Hammarlund Manufacturing Company, Inc.
460 West 34th Street
New York 1, N.Y.



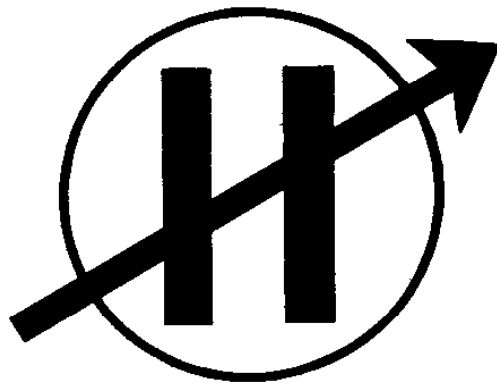

ESTABLISHED 1910