

The HAMMARLUND COMET "PRO"

H I G H F R E Q U E N C Y
S U P E R H E T E R O D Y N E

[SECOND EDITION: Revised to include Improvements]

AN OUTSTANDING RECEIVER FOR ONE AND TWO-TENTHS
TO TWENTY MEGA-CYCLES



THE Comet "Pro" is a high frequency superheterodyne receiver designed to meet the exacting demands of professional operators and advanced amateurs interested in the reception of both code and voice radio signals in the frequency range from 20,000 K.C. to 1200 K.C. In addition, it is suitable for various kinds of experimental and research work involving frequencies in that range where high sensitivity, low noise level, and great selectivity are important. The rather unusual tuning system as well as several other interesting features are described in detail in the following paragraphs.

Before taking up the actual description of the receiver it may be interesting to go over some of the more important considerations involved in short wave receiver design. First of all comes the question of power supply; shall it be

batteries or alternating current. Of course this controversy is automatically answered in situations where no alternating current is available, but these relatively few cases were disregarded and complete A.C. operation decided upon. There is really no comparison from the standpoint of convenience; in fact the only argument in favor of battery operation seemed to be from the standpoint of quietness of operation which is unquestionably of paramount importance in the reception of extremely weak signals. After some experimental work even this argument was disproved, as it was found perfectly possible to build an all A.C. receiver just as quiet in operation as the finest battery-operated receivers.

Next come selectivity and sensitivity, which while separate and distinct qualities in themselves, are nevertheless dependent on each other in most practical receiver designs. The superheterodyne, or double detection type of receiver, undoubtedly offers outstanding advantages in the matter of selectivity and sensitivity, especially where such a wide range of signal frequencies must be covered. Then once again the question of noise was raised—all superheterodynes were considered too noisy for satisfactory weak signal reception. But experimental work also disproved this theory and so work was started in earnest on an A.C. operated superheterodyne. An intermediate frequency of 465 K.C. was chosen as a compromise. It is below the broadcast band, and at the same time is high enough to provide a large spread between a desired signal and its "image" interference. By using Litz wound intermediate coils the selectivity and sensitivity are kept high. This and many other design features are described in more detail in the following paragraphs.

Tests on the final model were exceptionally gratifying. The selectivity is such that the over-all response curve averages only 30 K.C. wide at 10,000 times input. The sensitivity is so high and the receiver noise level so low that, under test in a prominent laboratory it was found possible to read a C.W. code signal at twenty words per minute (single transmission) when the input to the receiver was only 1/10 micro-volt. The signal was fed from a signal generator through a 200 ohm resistor to the "Ant" and "Gnd" terminals of the receiver. Dividing this figure by four gives a value of 1/40 micro-volt per meter (assuming an effective antenna height of four meters) which is the generally accepted measure of signal field-strength. A complete description of the receiver follows.

General Description

Interchangeable plug-in coils are used to shift from one frequency range to another. Two coils, one OSC and one W.L. constitute a set, and the tuning condensers are of such size that each set of coils covers a frequency range of approximately two to one. To provide ample overlap four sets of coils are used to cover the range from 15 to 250 meters. The coils are wound on extruded Isolanite forms 1½" in diameter. This results in high electrical efficiency and also great mechanical stability, which aids materially in maintaining dial calibrations. The coils plug into special extruded Isolanite sockets with double grip clips which make contact to opposite sides of each coil

prong, insuring reliable electrical connection with consequent freedom from noise due to variations in contact resistance. Any variation in resistance at these coil terminals would modulate the incoming signal carrier. Since these coil terminals are really the input to the receiver, any modulation at this point would be amplified by all succeeding stages resulting in serious noise in the output circuit. For this reason all switches or other sources of variable contact resistance have been avoided in the design of this receiver. Both OSC and W.L. coils are completely shielded in separate shield cans. The covers of these shields are readily removable to facilitate changing from one frequency range to another. The use of these coil shields eliminates all electro-magnetic coupling between OSC and W.L. coils as well as direct pickup from stray fields of any kind.

Band Spread Feature

The arrangement of the tuning condensers is interesting and unique. The

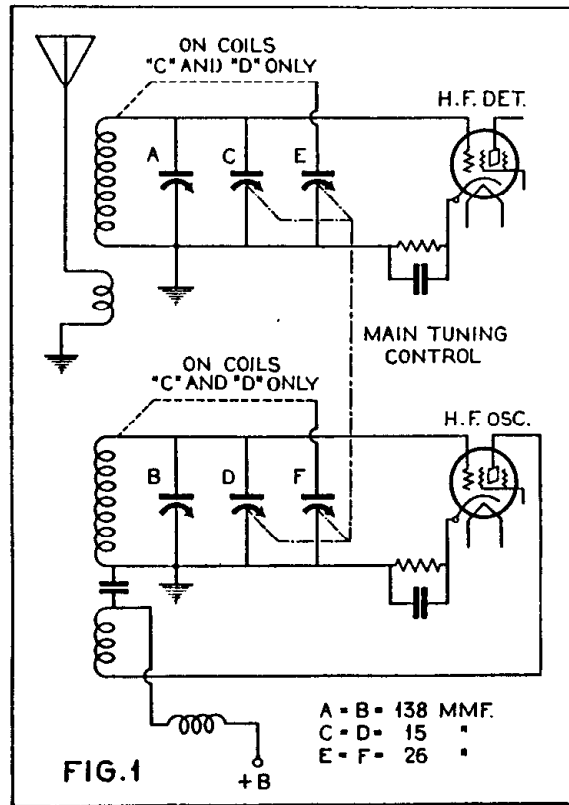

a band-spreading action on the four amateur bands of 20, 40, 80, and 160 meters, the same effect is obtainable throughout the entire range from 15—250 meters (20,000 to 1200 K.C.) Condensers A and B, of 138 mmf. each, constitute tank condensers and are individually controlled by separate vernier dials, one at left center and one at right center of the panel. By means of these two condensers, together with the appropriate set of coils, the receiver may be tuned to any frequency within its range. After this has been done, the main tuning dial, which controls condensers C, D, E, and F, will provide substantially true single control over a relatively narrow band of frequencies. If the main dial

is set at 50 when the adjustment of the two tank condensers is made, approximately half of the spread band will be above and the other half below the mean frequency determined by the choice of coils and the setting of the two tank condensers. If the main dial is at zero when the tank condensers are adjusted the entire spread band will be above that frequency. Conversely, setting the band with the main dial at 100 will throw the spread band on the lower frequency side. The dials on the two tank condensers are finely and accurately calibrated to facilitate precise logging. While calibration curves are furnished with each receiver, the operator should make an accurate calibration of his own receiver by means of standard frequency signals, certain stations known to be well controlled, etc. Very precise duplication of band settings can be made by logging a few "key" stations in or near a desired frequency band. The

for the 14 mega-cycle amateur band extending from 14 to 14.4 mega-cycles. After setting the tank condensers (with main dial at 50) as near as possible to 14.2 mega-cycles, let us assume that station XYZ is found at 7 on the main dial. The settings of both tank condensers and main dial for station XYZ should now

band, the tank condensers should be set as logged and the main dial set at 7. If station XYZ is heard (which is not very probable) all well and good. If not, a slight readjustment of the *tank* condensers will bring it in if it is on the air, after which the band setting of the receiver will be exactly the same as on the previous occasion when the original logging of station XYZ was made.

This type of band spreading circuit necessarily results in a non-uniform band width at various frequencies, and this fact should be taken into consideration by the operator. At 20 mega-cycles the band is approximately 1500 K.C. wide and narrows to 300 K.C. wide at 10 mega-cycles (using the "AA" coils). With the "BB" coils the band width is 1000 K.C. at 10 mc. and 150 K.C. wide at 5 mc. The band spreading on these two ranges is accomplished by the 15 mmf. condensers C. and D, Fig. 1, on the main tuning dial. These condensers alone are inadequate for proper band width in the 5 mc. to 1.5 mc. range covered by the "CC" and "DD" coils. In this range, the 26 mmf. condensers E and F (Fig. 1) are connected into the circuit also. However, no switch is necessary, as this additional connection is automatically made when the "CC" and "DD" coils are inserted in their sockets. The fifth coil prong (which is not used in Coils "AA" and "BB") is used for this purpose in Coils "CC" and "DD." In this frequency range the band width varies from approximately 1200 K.C. at 4.5 mc. to 225 K.C. at 1.5 mc.

A further advantage of the "tank" system of tuning used in the Comet "Pro" lies in its ability to overcome "image" interference which may be encountered under certain conditions. As is well known, there are two settings of the heterodyne oscillator of a superheterodyne receiver which will beat with the incoming signal to produce the desired intermediate frequency, which in

this case is 465 K.C. One of these is the signal frequency plus the I.F., the other is signal frequency minus I.F. In the Comet "Pro" the design of the tuned circuits is based on the use of the higher of these two oscillator settings, that is signal frequency plus intermediate frequency. Image interference encountered at this setting may be avoided by reducing the heterodyne oscillator frequency by

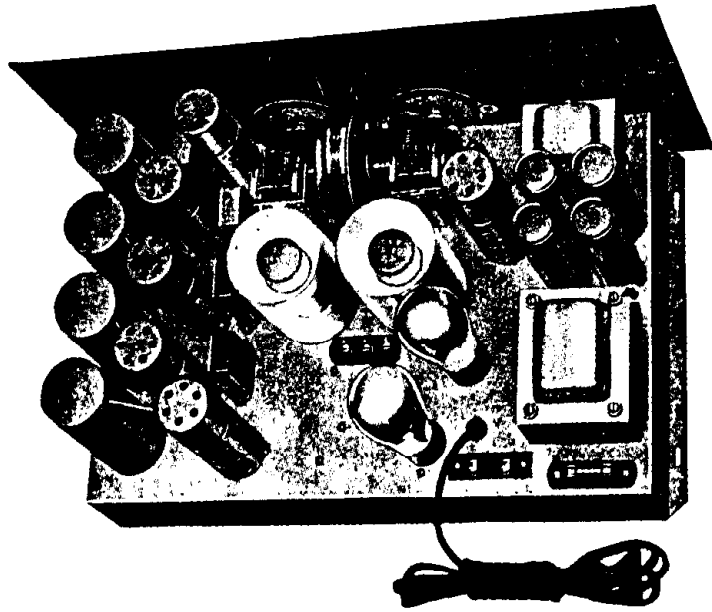

an amount equal to twice the intermediate frequency, or 930 K.C. This is accomplished by reducing the dial reading of the left hand "tank" condenser which controls the heterodyne oscillator tuning. The right hand, or W.L. dial should not be changed.

Electronic Coupled Oscillator

As will be noticed by inspection of the circuit diagram of the receiver the high-frequency or heterodyne oscillator is of the "electronic coupled" type. The many advantages of this type of oscillator for superheterodynes are too well known to enumerate here. A "58" tube is used with its suppressor grid grounded directly to the chassis, thus more completely isolating its plate from the oscillatory circuit. A small condenser of about 0.6 mmf. connected to the plate of the oscillator couples a small amount of its output directly to the grid of the first detector. This type of coupling, together with the shielding of the OSC and

Screen Grid Pentodes as Detectors and I.F. Amplifiers

The first detector is a "57" screen grid pentode. Its high detector sensitivity and high output impedance make it highly suitable to work into the high impedance primary of the first I.F. transformer. A further reason for its choice lies in its high input impedance and low effective input capacity, which together reduce the damping on the tuned input (W.L.) circuit at the same time permitting a larger frequency range to be covered with a given coil and condenser.

The two intermediate amplifying stages employ "58" variable-mu pentodes, and the intermediate coupling transformers are of the twin-coil tuned plate tuned grid type. Since the intermediate amplifier provides most of the receiver's sensitivity and selectivity, no effort has been spared in the design and construction of the intermediate transformers. The transformer coils are wound

with 10/41 Litz wire and have an inductance of 1.2 millihenries. At 465 K.C., these coils have a power factor of .01 or a Q of 100. They are tuned by adjustable condensers with mica dielectric and Isolantite bases. Inasmuch as six of these low loss tuned circuits are used in the three I.F. transformers, it is not difficult to account for the extreme selectivity shown by the overall performance curves of the receiver.

The second, or I.F. detector, is also a "57" screen grid pentode operated as a plate rectifier. Since its plate circuit contains a large I.F. component in addition to the desired audio frequencies a filter is necessary to remove it, otherwise undesirable feed back would result. This feed back can be very troublesome in a superheterodyne. In view of the fact that the tube is working as a rectifier, its plate circuit contains not only the fundamental intermediate frequency but also strong harmonic frequencies, especially the even ones. If not thoroughly suppressed these harmonics would induce voltages in the input circuit which would seriously hamper reception of signal frequencies at, or near, multiples of the intermediate frequency. In the Comet "Pro" this feedback has been minimized by exceptionally thorough filtering and shielding. A two stage filter consisting of three .00025 mfd. by-pass condensers and two 85 millihenry chokes is used. In addition each stage of this filter is completely enclosed in a separate shield compartment.

High-Power Output and Smooth Control or Sensitivity

The output tube is a "47", resistance-capacity coupled to the second or intermediate frequency detector. The high amplification and great power handling capabilities of this type tube insure good loud speaker volume even on very weak distant signals. An output transformer is mounted underneath the chassis with its secondary connected to the speaker terminal block at the rear edge of

4000 ohms. A tap on the secondary of the output transformer is connected through a resistor to the jack on the front panel, thus providing head-phone reception at reduced volume and with a minimum of hum. Due to the use of a built-in output transformer there is no direct current component at either the loud speaker terminals or the phone-jack. The jack is wired so that insertion of

the phone plug breaks the circuit to the speaker terminals, which can therefore be permanently connected to the loud speaker.

The volume control, or more properly, the gain or sensitivity control, consists of a variable biasing resistor in the cathode circuits of the two "58" intermediate amplifier tubes. In

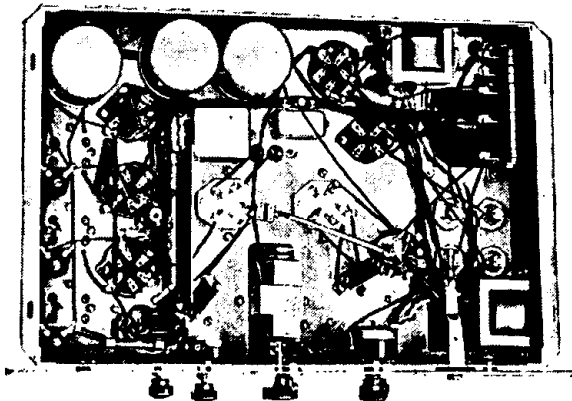

order to obtain wide control without using an excessively high variable resistance, a steady current of approximately five milliamperes flows through this bias control in addition to the plate and screen currents of the two tubes. This additional current has but little effect at low bias voltages where the tube current is high, but its effect increases rapidly as the tube current falls off at the higher bias voltages. The combination provides smooth as well as wide control of the overall sensitivity of the receiver.

A very important feature of the Comet "Pro" is the intermediate oscillator, which can be started and stopped by the toggle switch on the panel. It consists of a "58" tube and associated circuits permanently adjusted to oscillate at the intermediate frequency of 465 K.C. Like the high-frequency oscillator, it is also of the "electronic coupled" type. This results in great stability of oscillation and entirely eliminates the "pulling into step" effect when receiving strong C.W. signals. A small portion of its output is fed to the grid of the second or intermediate detector. Since all signals are changed to 465 K.C. by the combined

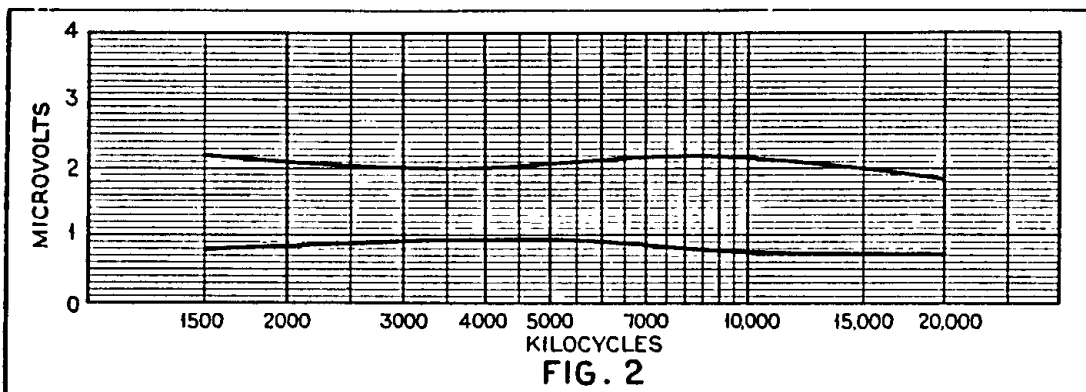

action of the heterodyne oscillator and the first detector, it is at once evident that starting the intermediate oscillator while a signal is being received will result in two 465 K.C. voltages being impressed on the second detector grid, one due to the heterodyned incoming signal and the other due to the local oscillator. Theoretically, this would result in zero beat, but in practice the tuning of the incoming signal is seldom so accurate, and the result is generally a rather low pitched whistle or audible beat note. It follows that by slightly readjusting the main tuning control, which in turn slightly varies the intermediate beat frequency generated by the first detector from the normal value of 465 K.C., the audible beat note can be adjusted to any desired pitch. This is an ideal condition for the reception of pure C.W. code signals, because no critical adjustments are necessary beyond the actual setting of the main tuning control. While it is unquestionably true that exceedingly weak C.W. signals can be successfully received with a simple oscillating detector, it is equally well known that such reception cannot possibly be accomplished unless "everything" is just right, and the critical adjustment which is just right for

one signal is rarely correct for another. With the Comet "Pro" the weakest signals can be tuned in merely by turning on the intermediate oscillator and then concentrating on the main tuning control. And, furthermore, once the weak signal is found, wide variations in its field strength, crashes of static or other electrical disturbances have no effect whatever on the adjustment of the receiver.

While this feature (the intermediate oscillator) was designed primarily for the reception of pure C.W. code signals, it is also extremely useful in other respects. When turned on, a whistle will be heard whenever any carrier wave is crossed during the process of tuning. By means of the zero beat method any such carrier can be quickly tuned to precise resonance, after which the oscillator may be turned off. In case the carrier is that of a phone transmitter voice or music will then be heard.

The intermediate oscillator tube and its associated circuits are completely shielded from the rest of the receiver. In this way its action is entirely independent of the other receiver adjustments, especially the sensitivity control, which would not be the case if some of its output were allowed to couple with the first intermediate stage. Such independence of action is highly desirable for reliable C.W. reception, since it is substantially constant irrespective of the field strength of incoming signals. Any operator accustomed to a regenerative receiver will appreciate this advantage. In addition, adequate shielding is necessary to prevent harmonics of the I.F. oscillator from reaching the receiver input, where they might prove troublesome.

The whole question of shielding has been very carefully worked out and is culminated in an all-metal cabinet which encloses the entire receiver. Made of heavy gauge, patent levelled steel with black crinkle finish, this cabinet constitutes a handsome housing for the receiver and in addition limits all pickup to that afforded by the antenna itself. Fifteen ventilating louvres provide ample circulation of air for heat dissipation.

Performance Data

In Fig. 2, is shown the sensitivity of the receiver throughout its tuning range. Both curves show actual output from the standard signal generator which was connected to the antenna and ground terminals of the receiver through a 200 ohm non-inductive resistor. They indicate the micro-volts input to the receiver necessary to produce the standard head-phone output of .006 watts, which in this case was 7.3 volts across a load of 8860 ohms. The upper curve, marked I.C.W., was made with 100 per cent modulation at 400 cycles, while the lower curve, indicating somewhat more than twice the sensitivity, was made with pure C.W. heterodyned by the intermediate oscillator to an audio frequency in the neighborhood of 800 cycles. The higher sensitivity for C.W. is accounted for by the increased efficiency of the second detector when its grid circuit is excited by the local intermediate oscillator. This increase in detector sensitivity is quite noticeable when the intermediate oscillator is started when no signal is being received, especially if the sensitivity control is advanced.

The selectivity of the Comet "Pro" is shown by the overall response curves of Fig. 3, which represents off-resonance field strength ratios

adjusted to maximum sensitivity, therefore the actual micro-volts input to the receiver at any point on a curve was approximately two times the indicated field strength ratio at that point. All curves were made with I.C.W., the modulation frequency being 400 cycles. Curve "A" was made at 1500 K.C. using 30% modulation, curve "B" at 3750 K.C. with 70% modulation, and curve "C" at 19,000 K.C. also with 70% modulation. The substantial uniformity of these three curves taken at such widely different signal frequencies

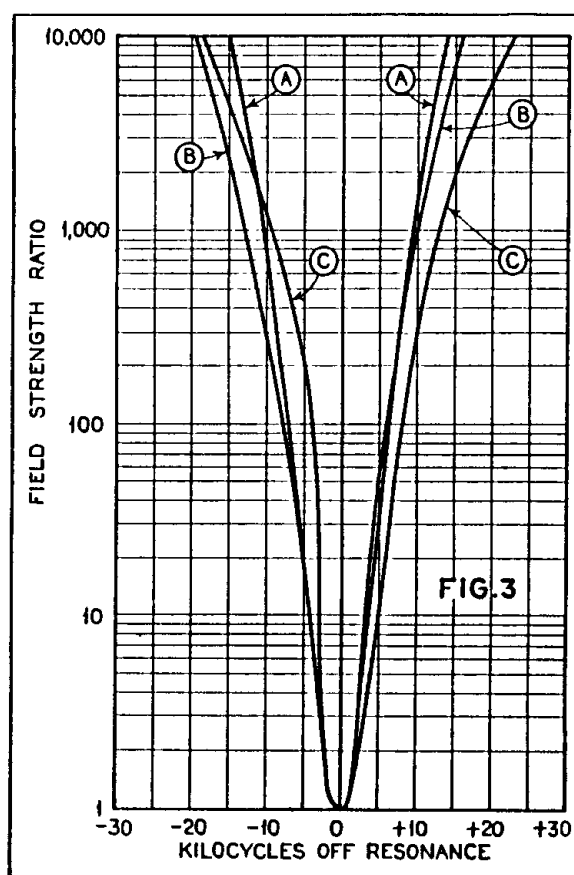

demonstrates very clearly one of the advantages of the superheterodyne circuit in high frequency radio reception.

Figs. 4, 5, 6, and 7 show the tuning characteristics of the four sets of coils, "AA," "BB," "CC" and "DD." As mentioned previously these charts are intended only as a guide to tuning, being exact only for the receiver from which they were made. However, the manufacturing variations between individual receivers are not very great, and therefore these charts will probably be correct within a few per cent for any receiver. To simplify the charts only the oscillator tank condenser tuning is shown. While the W.L. (or right hand) tank condenser setting will not track exactly, its proper setting will in general be within a few

degrees of that of the oscillator. Its setting can easily be found by the rushing sound, which is loudest when the W.L. circuit is resonant to a frequency 465 K.C. below (or above in some cases) that of the oscillator. The solid line curves on these charts are the calibrations of the oscillator (left hand) tank condenser when the band spreading dial is set at 50. The upper and lower dotted line curves represent the calibrations when the band spreader dial is set at 100 and 0, respectively. Consequently, the vertical distance between these two dotted line curves at any given setting of the oscillator tank dial indicates directly the frequency range covered by the band spreading dial for that particular oscillator setting.

Installation

The standard Comet "Pro" is intended for use with 110 volt, 60 cycle A.C. current only, and should never be connected to any other source of supply. A protective fuse, rated at $1\frac{1}{2}$ amperes, is mounted near the rear edge of the chassis at the left. This fuse is connected in series with the 110 volt line and should be examined in case the tubes fail to light. Where alternating current is available, but of different voltage or frequency, a suitable receiver can usually be supplied on special order. Where direct current only is available a small motor-generator of at least 75 watts capacity is recommended to supply the regular 110 volt, 60 cycle A.C.

Each socket is plainly marked with its proper tube number. The standard receiver uses eight tubes, viz., one "80," one "47," two "57" and four "58."

A battery-operated model is also available, using four "39," two "36" and one "89." These tubes are the highly efficient non-microphonic, automobile type, drawing only .3 amperes at 6.3 volts.

No special selection of tubes is necessary, but actually defective tubes must of course, be avoided. This is especially true of the "58" used as the short wave oscillator (to the left of the OSC coil). Occasionally a tube will be found with an abnormally high hum level, and when used as an oscillator will modulate all incoming signals with a low pitched hum or warble.

Antenna Systems

No special type antenna is required, and almost any length will prove satisfactory, except in locations where severe interference is encountered. Under such conditions a rather short antenna will generally improve matters. However, too much stress cannot be put on the need for experiment in the matter of antenna lay-outs for short wave reception. Each receiving location has its own peculiarities and since the receiver noise level in the Comet "Pro" is so exceptionally low, any improvement in the signal to noise ratio of the antenna system will pay big dividends in the form of improved weak signal reception. Ground connections are also a matter for experiment. All variable or high resistance joints must be carefully avoided in both antenna and ground systems.

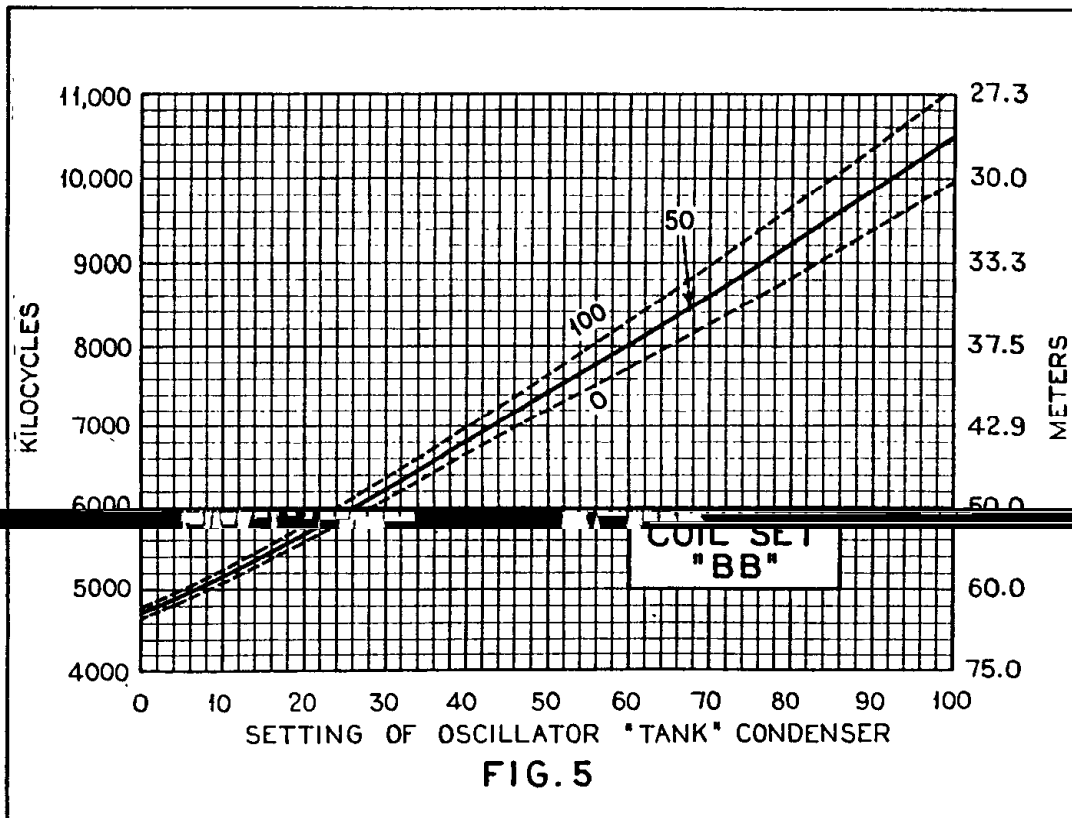
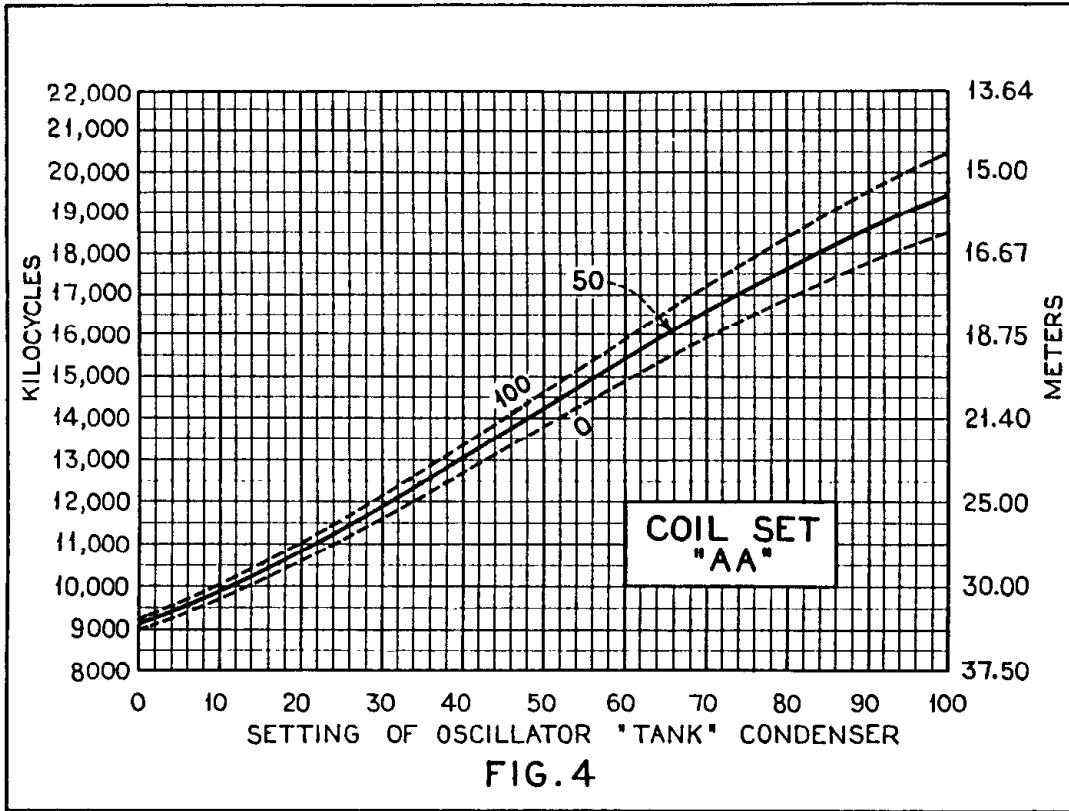

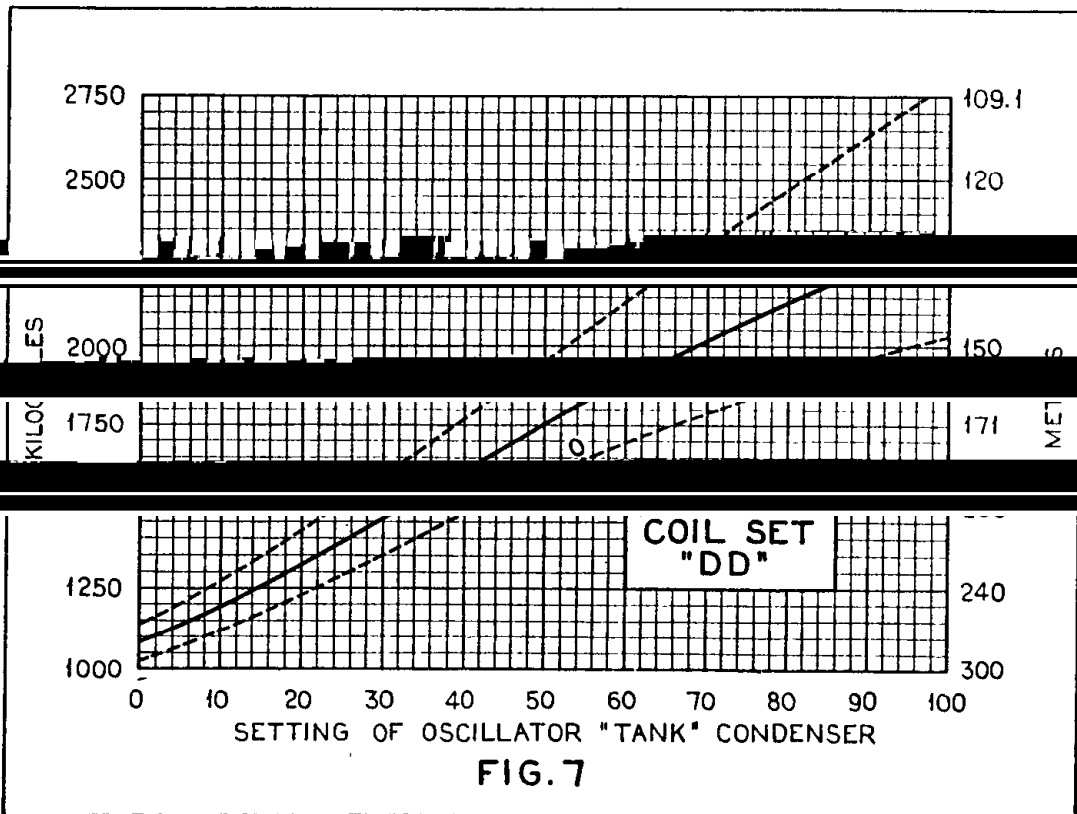
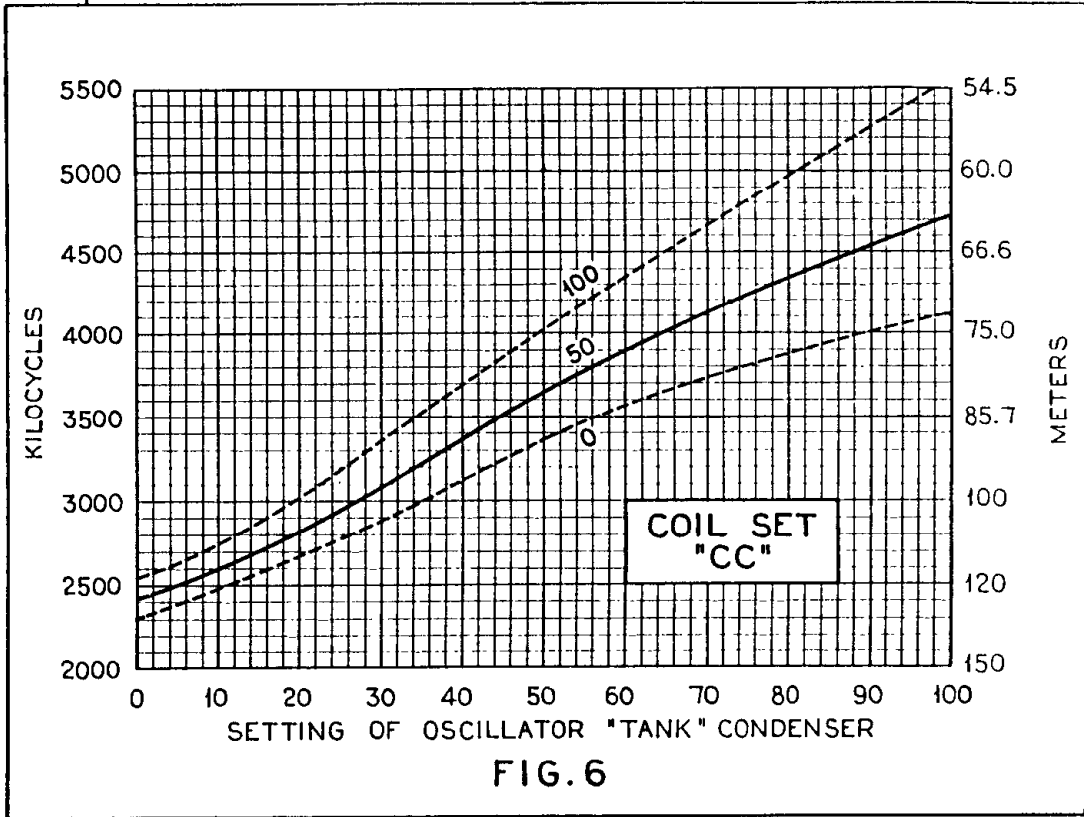

Various types of balanced antenna systems such as doublets often provide improved reception at high frequencies. For proper operation of such a system the primary of the antenna coupler in the receiver should not be grounded. In the Comet "Pro" a three terminal "Ant-Gnd" block is used. The two "A" terminals are connected to the ends of the primary of the W.L. coil and the "G" terminal is connected to the chassis. The two leads from any balanced antenna systems may therefore be connected to the two "A" terminals. When the conventional Antenna and Ground arrangement is used a jumper should be connected from the "G" terminal to the adjacent "A" terminal, and then to the ground wire. The remaining "A" terminal should then be connected to the antenna. When using a balanced antenna system connected to the two "A" terminals, the "G" terminal may or may not be connected to ground depending on which condition yields better results.

Operating Details

The set is turned on and off by means of the lower left-hand knob. This knob is a combination switch and tone control; the tone control attenuates the higher audio frequencies and serves to reduce the noise under certain receiving conditions. The lower right-hand knob is the sensitivity control and should be advanced to the point where a slight rushing sound is heard when searching for stations.

The toggle switch at the center of the panel below the main tuning knob controls the intermediate oscillator which enables the reception of C.W. code signals and greatly facilitates searching for "phone" carrier waves.

The two Isolantite sockets in the center of the chassis are for the interchangeable tuning coils. Coils marked "OSC" go in the left-hand socket (looking at the receiver from the front) and those marked "W.L." go in the right-hand socket. Although the receiver will not function properly no damage will be done if a coil is accidentally inserted in the wrong socket.

Although the tuning system of the receiver has already been described in detail an actual illustration is given below. To set the receiver to the 3.5 to 4 mega-cycle amateur band, proceed as follows:

Plug in the "CC" coils, (CC-OSC) in the left-hand Isolantite socket.

Set the band spread dial at 50.

Set the two "tank" dials at 53 (per Fig. 6).

The receiver will then be tuned to approximately 3700 K.C. and the band spreading dial alone, after slight readjustment of both "tank" dials, will cover the entire band of frequencies between 3500 K.C. (at about 10) and 4000 K.C. (at about 90). In the same manner the receiver can be set to any other band.

Of course, if desired, the receiver can be tuned just like any other two dial receiver, merely by ignoring the band spreader dial and rotating the two

tank condenser dials approximately in step with each other. If the band spreader dial is set at 50 during this operation, it can be used as a vernier after a station is located. Thereafter, any other stations known to be on frequencies but slightly different from that of the station tuned may easily be located by the band spreader dial alone.

The following list of approximate voltages is given for checking purposes. All circuit constants are given in the circuit diagram. A D.C. voltmeter having a resistance of at least 1000 ohms per volt should be used for checking. With the negative terminal of the meter connected to the chassis the following readings should be obtained:

| | <i>Volts (Approximate)</i> | |
|---|----------------------------|---|
| Top terminal of voltage divider..... | 250 | “ |
| Second terminal of voltage divider..... | 130 | “ |
| Third terminal of voltage divider..... | 40 | “ |
| Fourth terminal of voltage divider..... | 0 | “ |
| Bottom terminal of voltage divider..... | 17 | “ |
| K terminal of first detector..... | 6 | “ |
| K terminal of first and second I.F. (Max.)..... | 45 | “ |
| (Varies with volume control) (Min.)..... | 3 | “ |
| K terminal of second detector..... | 6 | “ |
| P terminal of second detector..... | 165 | “ |
| P terminal of H.F. oscillator, first and second I.F., first detector, and I.F. oscillator..... | 250 | “ |
| G terminal of first detector, second detector, and first and second I.F. | 110 | “ |
| G terminal of H.F. oscillator..... | 100 | “ |

Adjusting I.F. Alignment and I.F. Oscillator Frequency

Tune in a steady carrier, preferably about 200 meters, and not too weak. Connect a high resistance voltmeter across the cathode bias resistor of the second detector. This meter should read around 7 or 8 volts with no signal. Then adjust the volume control, after tuning in a signal, so that the meter reads about 2 volts greater than the “no signal” reading. Carefully tune the main dial for greatest voltmeter reading. Then readjust each intermediate frequency tuning condenser for greatest voltmeter reading. After adjusting each condenser the volume control should be reduced slightly if the voltmeter goes much over 10 volts. When all six intermediate frequency oscillator condensers have been peaked, the intermediate frequency oscillator condenser should also be reset. This condenser can be reached through the hole in the shield in the corner of the underside of the chassis. Adjustment should be made for zero beat or nearly so. During all the foregoing adjustments, the main tuning dial should not be disturbed.

PRICE LIST

The Comet "Pro" Short Wave Receiver is regularly supplied for 110-115 volt, 50-60 cycle current supply. A battery operated model is also available. For direct current operation a suitable motor generator is required. The complete receiver measures 20 $\frac{3}{4}$ " x 13 $\frac{3}{4}$ " x 9 $\frac{1}{2}$ " high.

| <u>Description</u> | <u>List Price</u> |
|---|-------------------|
| A. C. Model | |
| "Pro" Receiver, with tubes | \$162.55 |
| "Pro" Receiver, less tubes | 150.00 |
| "Pro" Chassis, with tubes | 147.55 |
| "Pro" Chassis, less tubes | 135.00 |
| Tubes only, for "Pro" Receiver, per set | 12.55 |
| *Cabinet only, for "Pro" Receiver | 15.00 |
| Battery Model | |
| "Pro" Receiver, with tubes | \$138.60 |
| "Pro" Receiver, less tubes | 120.00 |
| "Pro" Chassis, with tubes | 123.60 |
| "Pro" Chassis, less tubes | 105.00 |
| Tubes only, for "Pro" Receiver, per set | 18.60 |
| *Cabinet only, for "Pro" Receiver | 15.00 |
| Accessories | |
| "Pro" Permanent Magnet Dynamic Speaker Unit | 15.00 |
| "Pro" Plug-In Tuning Coils, per pair | 5.00 |

Note:—All tubes are tested R.C.A. Radiotrons.

*Metal cabinet is standard equipment. The old type walnut cabinet is available as optional equipment at no additional cost.

Special coils are available to extend the range of the receiver to 550 meters.

Special "Pro" Receivers can be supplied for 220 volt, 60 cycle operation and for 110 volt, 25-40 cycle operation. List prices of these special models are \$10.00 higher than for the standard 110 volt, 60 cycle model.

For certain types of commercial service some modification of the standard receiver may be advantageous. Prompt attention will be given any such problems submitted.

The HAMMARLUND MANUFACTURING CO., Inc.

424-438 West 33rd Street, New York