

# HALLICRAFTERS

## SX-11

### COMMUNICATIONS RECEIVER

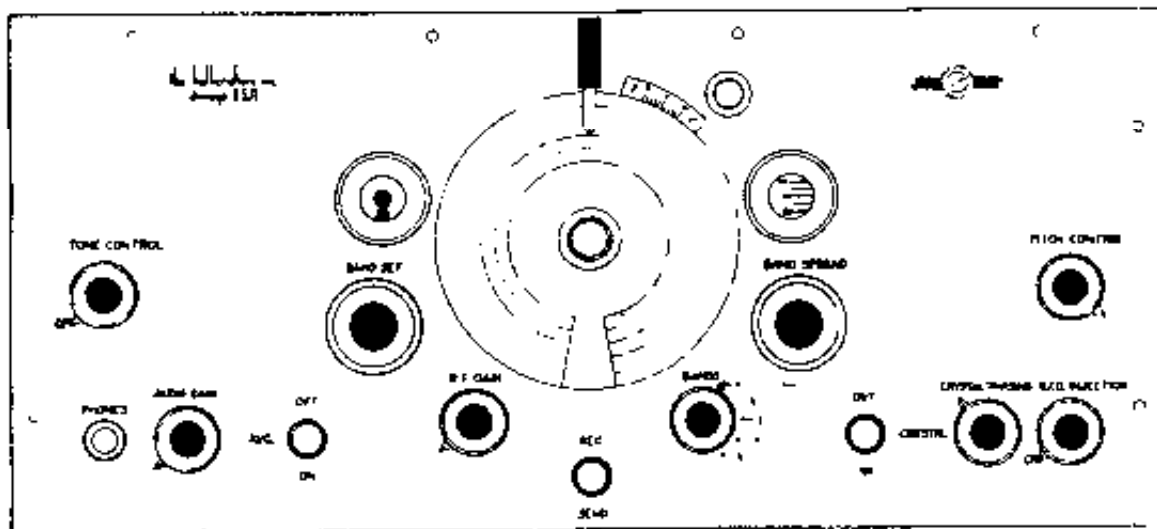

SX-11 Super SKYRAIDER

OPERATING INSTRUCTIONS

The new 1937 Super SKYRIDER is a 5 band 11 tube superheterodyne receiver covering the following frequency ranges.

- No. 1 Band -- 545 KC to 1230 KC (550 to 243 meters.)
- No. 2 " -- 1.18 MC to 2.85 MC (254 to 105 meters.)
- No. 3 " -- 2.75 MC to 6.82 MC (109 to 44 meters.)
- No. 4 " -- 6.75 MC to 16.40 MC ( 45 to 18.3 meters.)
- No. 5 " -- 15.40 MC to 38.10 MC (19.5 to 7.85 meters.)

The coil range in use is indicated by the pointer on the main dial. This pointer moves vertically when the band-change switch is moved. The calibration on this dial is in megacycles on all but Band No. 1 where it is in kilocycles. This calibration will hold

- No. 1 Band covers the American Broadcast range up to 1,230 KC. (243 meters.)
- No. 2 Band covers from 1.18 megacycles (254 meters) to 2.85 megacycles (105 meters.) With the receiver operating in this position the remainder of the broadcast band can be covered. From 1.50 megacycles up in frequency you will receive high-fidelity experimental broadcast, aircraft, amateur and police stations.
- No. 3 Band covers from 2.75 megacycles (109 meters) to 6.82 megacycles (44 meters). Operation in this position will allow you to receive the 3.5 megacycle (80 meter) amateur band, standard frequency transmissions, aircraft, police and the 6. megacycle (49 meter) short wave broadcast band.
- No. 4 Band covers from 6.75 megacycles (45 meters) to 16.40 megacycles (18.3 meters). With the receiver operating in this position you will receive 7000 KC amateur code stations; 9.5 megacycles (31 meter) broadcast; 12.00 megacycle (25 meters ) broadcast; 14.00 megacycle (20 meters) amateur code and phone stations; 15.80 megacycle (19 meters) broadcast. On this band will be found the greatest number of broadcast transmissions, both foreign and local.
- No. 5 Band covers from 15.40 megacycles (19.5 meters) to 38.10 megacycles (7.85 meters.)

Operation with the receiver in this position will allow reception of 15.80 megacycle (19 meters) broadcast. It is suggested that band No. 4 be used for reception of this band. You will find that reception on this band is most seriously affected by changeable radio conditions on these frequencies. The 28.00 megacycle (10 meters) amateur band will allow reception of signals only over relatively great distances (seldom less than 1500 miles) when this band is "open." It will be easier to receive signals on this band during the daylight hours.

#### TO OPERATE

After taking the receiver from the shipping case, remove the thumb screws holding the dust-cover to the chassis and panel. Remove the dust-cover and then adjust the 6G5 magic eye tube so that it will be properly aligned with its hole in the panel. Before replacing the dust-cover remove the protecting paper shields over the glass tubes. These precautions have been taken to protect these tubes in shipment.

On the lower right hand corner on the back of the chassis you will find a terminal strip marked 5000 ohms. To this strip connect the permanent magnet speaker. The terminal strip marked 500 ohms directly above the 5000 ohm strip can be connected to a load of that impedance. The other terminal strip to the right of these two and marked EXT. SW. is used to turn the set on and off for a stand-by. This strip when connected to a relay or a separate set of contacts on an external switch will turn the set on and off temporarily when the send - receive switch on the front panel is in the "send" position.

In the back to the left of the chassis will be found the insulated antenna and doublet binding posts. If a doublet antenna is used, remove the jumper from the one insulated post to the chassis and connect the two wires from the doublet to the insulated posts. Please remember that the regular short wave doublet antenna is designed to work best on the short-wave broadcast frequencies. This means that it will not perform equally well on the amateur bands or frequencies in between the short wave broadcast channels. When using the conventional flat-top and lead-in type of antenna, connect the lead-in to the insulated post farthest to the left, being sure that the wire jumper is connected to the chassis and the other insulated post. Antenna location, length and type play a most important part in the successful operation of the set, especially on the two high frequency ranges. It is suggested that a little experimenting be done with the antenna so that maximum performance will be secured.

Plug the cord on the receiver into the power socket. (Unless otherwise specified the receiver operated on 60 cycle, 110 volt alternating current.) Turn the control marked "Tone" to the right. This will connect the receiver to the A.C. line. During the time the receiver is warming up also turn the "R.F. Gain" and "A.S. Gain"

knobs to the right. The receiver is shipped with the band-change



the higher frequencies. Turn the larger knob marked "BAND SET" until the desired frequency is reached. When listening for distant or possibly weak stations, it is recommended that the control marked "BFO INJECTION" be used by turning that knob to the right. Once these signals are located, it should be turned off, or a continuous whistle will result. When listening to C.W. transmissions the control must be left turned on. The "PITCH CONTROL" knob directly above "BFO INJECTION" will prove most helpful in changing the beat note to one most pleasing to the operator.

The vernier scale above the main dial and to the left of the pilot light housing will prove valuable in accurately re-setting the main dial to within a tenth of one division.

Referring to Figure 3, the drawing to the left shows how the main dial and the vernier scale would line up with a reading of 70 degrees on the nose.

In the middle drawing is shown how the main dial and the vernier would appear in reading between 20 and 21 degrees. We find degree No. 3 the only one on the vernier scale which lines up with any degree on the main dial, so the reading is 20.3 degrees.

In the third drawing, we are attempting to read the tenths of a division between 50 and 51 degrees. We find the 5th division is the only mark on the vernier scale which lines up with any division on the main dial so the reading is 50.5 divisions.

When receiving voice, whether broadcast or short wave, it is recommended that the "A.V.C." switch be left in the "ON" position. The "R.F.GAIN" control with the "A.V.C." switch in the "ON" position should be turned as far as it will go to the right. It will be noticed that with the "A.V.C." switch "OFF" and the "R.F.GAIN" wide open the set will block on strong signals. If maximum sensitivity is desired the "A.V.C." switch can be left in the "OFF" position. The sensitivity may be manually controlled with the "R.F.GAIN" control. It will be found that by optional adjustment of both "R.F." and "A.F." gain controls the most favorable ratio of signal to noise will be secured.

For the reception of C.W. signals, the "A.V.C." switch should be in the "OFF" position and the "BFO INJECTION" control turned on. Variation of this control changes the output of the beat oscillator. Weak signals which would normally be inaudible with a strong beat oscillator are easily copied with the control just on. Turning the knob as far as it will go to the right gives maximum beat oscillator output.

CRYSTAL OPERATION

To properly adjust the crystal circuit for best performance the following procedure should be carefully followed.

Be sure that the "BFO INJECTION" control is in the "OFF" position.

Tune to some station transmitting continuously, being very careful to get the signal on the nose. After you are sure you have the signal resonated perfectly, turn on the "BFO INJECTION" control to nearly maximum position.

Check your tuning and be sure you still have the signal perfectly tuned-in.

Now change the "PITCH CONTROL" being sure that it is operating properly. Proper operation of this control will be indicated by hearing the signal twice in one complete rotation of the knob, there being two positions in which no signal will be heard. These are known as the zero beat positions.

Snap the crystal switch to the "ON" position. You will notice a great reduction in noise. Carefully retune the signal on the "BAND SPREAD" dial. Notice how sharply the signal peaks, with normal volume again obtained. Now tune through the signal and find which side of the signal is the weaker. Tune in the weaker side and then carefully adjust the "PHASING" condenser control until the weaker signal is inaudible. Retuning to the other side of the signal should find no change in its volume and knife-like selectivity resulting. Whichever side of the zero-beat adjustment of the "PITCH CONTROL" gives the greater rejection of the image, that is the adjustment to be used for maximum selectivity. The phasing condenser affects the selectivity of the receiver whether the crystal is in the circuit or not. The crystal may be used in the reception of phone signals with some sacrifice in their quality.

Again you are reminded to tune this receiver with care. Because of its extreme selectivity, you may expect the most satisfactory results only after familiarizing yourself with its operation.

The tube line-up in the new 1937 Super SKYRIDER is as follows:

6K7	Pre-selector, R.F. amplifier
6L7	1st Detector-mixer
6C5	Signal frequency oscillator
6K7	1st I.F. amplifier
6K7	2nd I.F. amplifier
6K7	2nd detector; A.V.C.; 1st stage of audio
2 6L6	Push-pull 2nd audio stage
6K7	Beat oscillator
5Z3	Full-wave rectifier
6G5	Tuning indicator

Separate coils are used to cover each band. Inductive coupling of the signal picked up by the antenna permits the maximum transfer of energy from each separate primary to the particular secondary range in the circuit. The unused coils are shorted.

The 6K7 r.f. stage gives maximum gain in relation to frequency and provides pre-selection which gives an image ratio of 80 to 1 on the highest frequency range.

The first detector-mixer is a 6L7. The output from the 6C5 signal frequency oscillator is electron coupled to the injector, or No. 3 grid, of the 6L7. Because no oscillator plate current flows in the 1st detector, the ratio of translation to noise is more favorable than that obtained in a composite tube, or in circuits where the cathodes of two tubes are tied together.

The 6C5 oscillator has separate coils for each band. The superior overall performance is the result of not using any harmonics of the signal frequency oscillator throughout the tuning range of the receiver.

All intermediate frequency transformers are of the iron-core type and resonate at 465 KC. This type of transformer has so definite-

that a signal of maximum strength is impressed on the low impedance

primary of the crystal output transformer. The crystal filter with its phasing condenser is inserted between these transformers. With proper adjustment of the phasing condenser single signal operation can be secured. When the crystal is shorted, or the crystal switch is in the "OUT" position, the signal is impressed directly on the crystal output transformer which feeds the grid of the 6K7 first I.F. stage.

The second and third I.F. transformers are identical and pro-

---

vides an order of gain and selectivity which has heretofore never been obtained in communication receivers. The I.F. selectivity of the 1937 Super SKYRIDER, without crystal, at 100 times input is 11 KC.

The 6K7 second detector gives half-wave diode detection, A.V.C., and the triode section of this tube is the first stage of audio amplification. The plate of this section of this multi-purpose tube is transformer coupled to the grids of the push-pull 6L6's.

The push-pull 6L6 stage running straight Class "A" delivers 14 watts of undistorted audio power. Before actually drawing any grid current the output is in the neighborhood of 17 watts.

The beat oscillator is a 6K7 electron-coupled to the diode section of the 6K7.

The high-current 5Z3 rectifier provides ample current for the complete receiver with its push-pull 6L6 audio output stage.

In this receiver the speaker is not a portion of the filter system. This allows the receiver to be operated independently of the speaker itself. A permanent magnet 5000 ohm speaker is the type we recommend being used with this receiver.

The headphone jack is connected to the input of one of the 6L6 output tubes. The possibility of shock to the operator is eliminated by having no direct current on the phones.

The total consumption of power by this receiver is 127 watts.

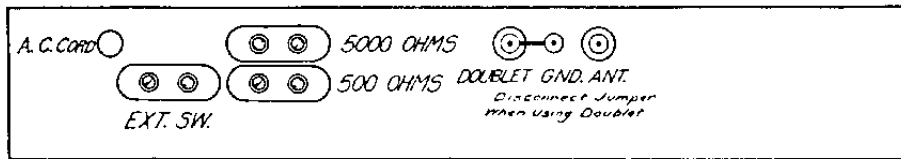

MODEL S-11 SX-11

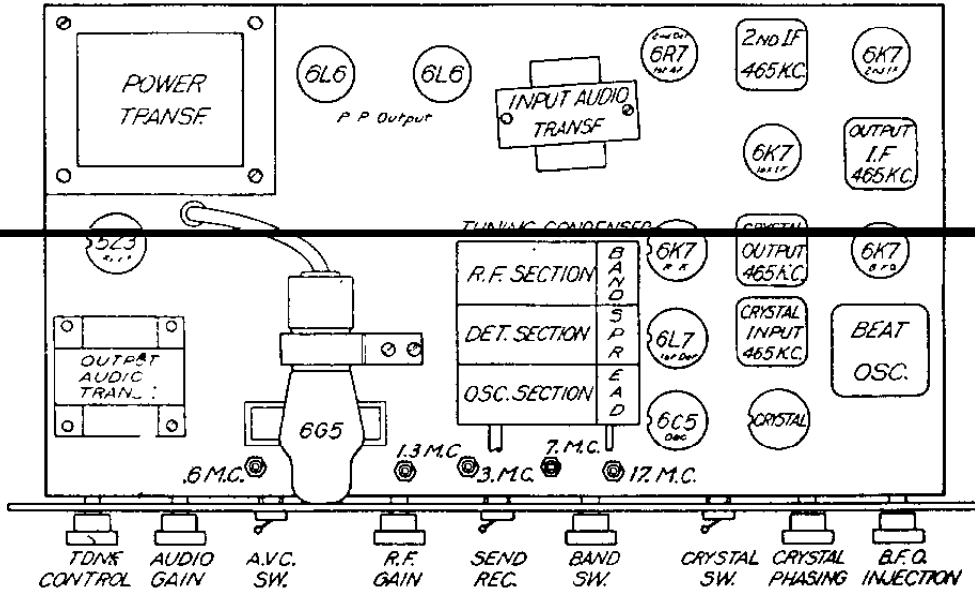

Fig 1

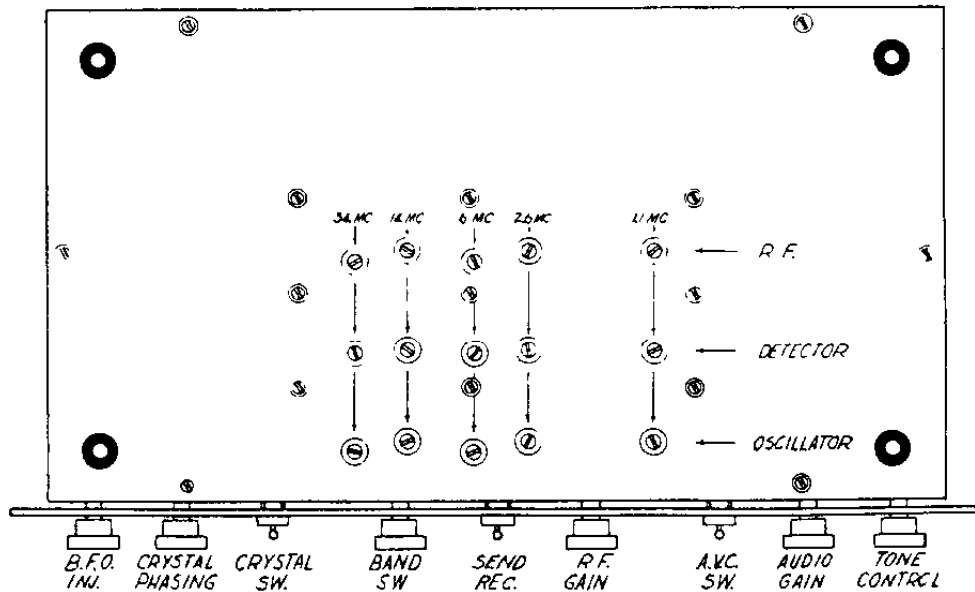

Fig 2

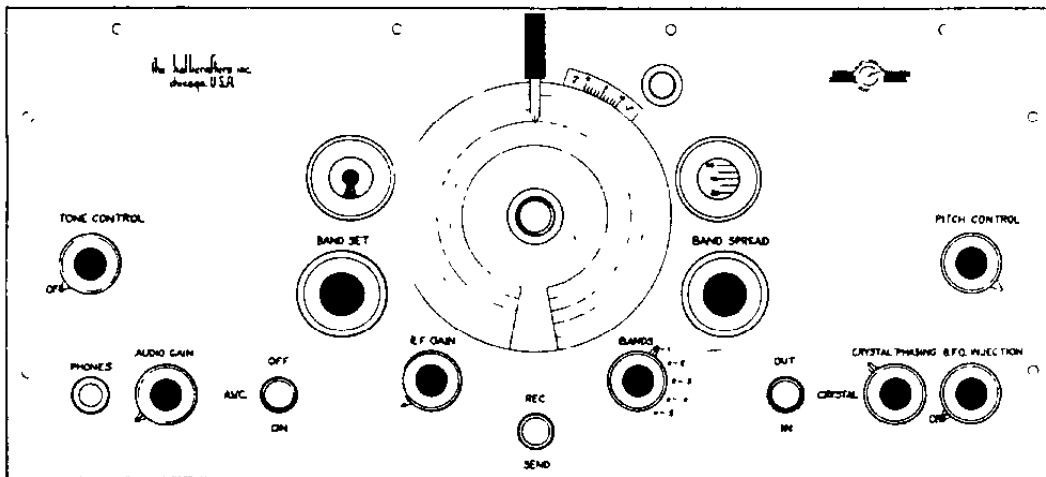
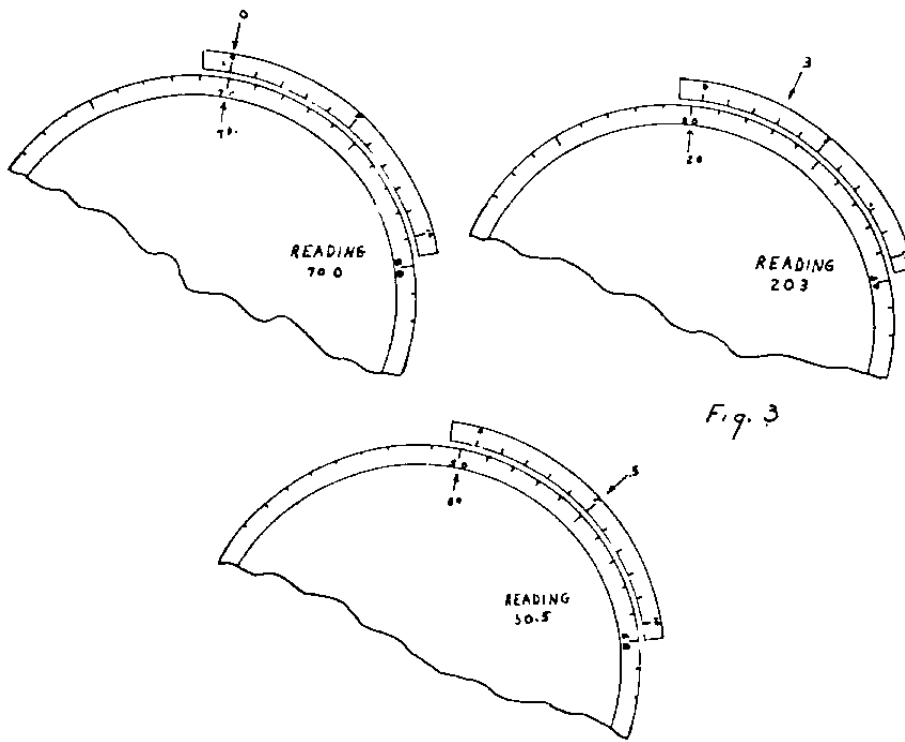

Fig. 4

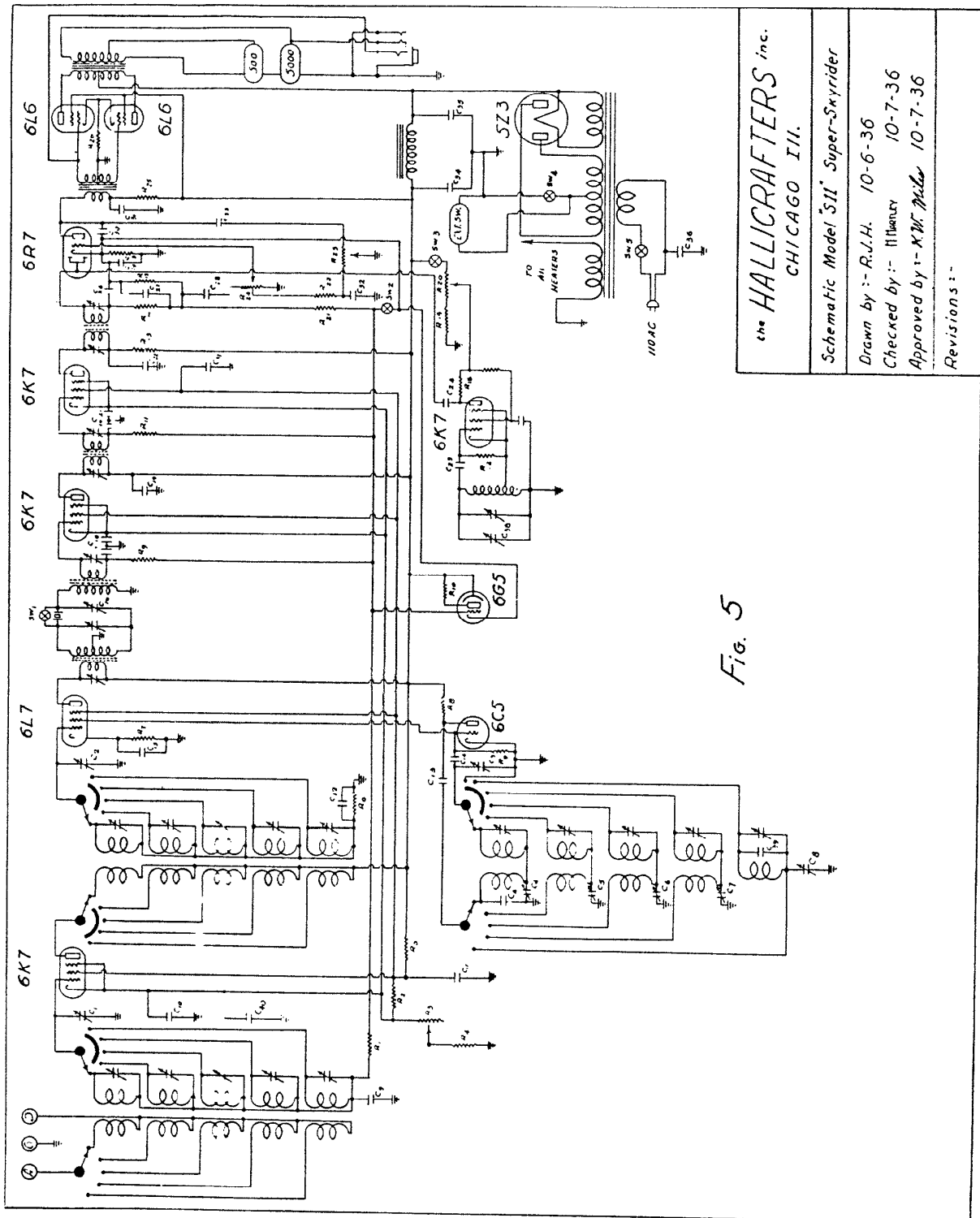

Fig. 5

the **HALLCRAFTERS** inc.  
 CHICAGO III.

Schematic Model 511 Super-Swydrider

Drawn by :- R.J.H. 10-6-36

Checked by :- H.H. 10-7-36

Approved by :- K.W. 10-7-36

Revisions :-

MODEL S-11 - PARTS LIST

CONDENSERS

C 1	Rear Section Variable	250 MFD.	)	
2	Middle Section Variable	" "	)	48011
3	Front Section Variable	" "	)	
4	.0012 Padders Mica Variable			44012
5	" " " "			44012
6	" " " "			44012
7	.00039 " " "			44008
8	.0002 " " "			44006
9	.002 5% mica			43012
10	.002 20% mica			40013
11	.05	400 v		41005
12	.002 5% mica			43012
13	.002			40013
14	.0001 mica			40003
15	.002 20% mica			40013
16	.000025 Crystal Phasing Variable Air			48012
17	.02	200V		41002
18	.05	200v		41004
19	.25	400V		41009
20	.02	200V		41002
21	.02	400V		41003
22	.05	400v		41005
23	.00025 mica			40007
24	.00001 Twisted Pair			
25	.05	200V		41004
26	.00025 Mica			40007
<hr/>				
30	.0005 mica			40009
31	1 MFD.	400		41013
32	.005	200 v		45004
33	.01	400 v		41001
34	16 MFD.	400 V Dry Electro.		42018
35	16 MFD.	400 V Wet Electro.		42019
36	.01	400 V		41001
37	.1	400 v		41007
38	.000025 Pitch control	Air Variable		48012
39	.00001 10% Mica			43020
40	.25 MFD.	200 v		41008
41	.00005 Mica			40002
42	.05	400		41005

MODEL S-11 - PARTS LIST

RESISTORS

	<u>OHMS</u>			
R 1	100,000	1/3		20093
R 2	30,000	1	10%	22075
3	10,000	R F Gain		25009
4	400	1/3	10%	22033
5	15,000	2	10%	24034
6	100,000	1/3		20093
7	600	1/3	10%	22125
8	10,000	2		24033
9	50,000	1/3		20084
10	1,000,000	1/3		20108

18	1,000	1/3	10%	22052
19	50,000	1/3		20084
20	500,000		B.F.O. Injection	25014
21	1,000,000	1/3		20108
22	20,000	1/3		20072
23	1,000,000		tone control	25013
24	500,000		volume control	25012
25	10,000	1/3		20069
26	250	Cardehm	10%	24013
27	100,000	1/3		20093
28	250	Cardehm	10%	24013

## ALIGNMENT PROCEDURE FOR SUPER SKYRIDER S-11

Intermediate frequency alignment.

If the receiver is equipped with a crystal, use the crystal in a separate oscillator.

If the receiver is not an SX11 model, set the signal generator for 465 KC output.

Before I.F. or R.F. alignment see that:

AVC switch is off

Crystal switch is off

B.F.O. switch is off

Audio gain control set at maximum

R.F. gain control set at maximum

Crystal phasing condenser adjusted for maximum noise level.

Do not remove bottom plate from chassis.

Remove 6C5 oscillator tube from its socket and connect generator output directly to the grid of the 6L7 iat. detector.

As an output indicator, it is suggested an 0-3 volt A.C. voltmeter be connected across the speaker voice coil.

Now adjust all I.F. transformers for maximum output.

### R. F. Alignment

Check dial- at maximum capacity of gang condenser the dial should stop so that "0" on the main tuning dial should be opposite "C" on the vernier scale.

Set band spread condenser at minimum capacity or so that it reads 200 degrees.

Put the 6C5 oscillator tube back in its socket.

Connect generator output through 400 Ohm resistor to antenna and ground points on receiver (Jumper should remain connected)

Put receiver on band #1

Set dial to reading of 600 KC.

Now adjust .6MC pad on top of chassis until signal is reactivated.

Reset dial to 1100 KC

Reset generator to 1100 KC

Adjust 1.1 megacycle osc. trimmer condenser beneath the chassis until this signal is properly resonated.

Now adjust R.F. and detector trimmers for maximum gain.

Now reset dial and generator to 600 KC and re-pad above chassis.

It may be necessary to pad and trim at 600 KC and 1100 KC a few times as a change of capacity at one end will affect the other end.

Re-check on R.F. and detector trimmers and peak for maximum gain.

---

Band # 2

Same procedure as on band #1 except pad (above chassis) at 1.3 M.C.  
Trim at 2.6 M.C.

---

Band #3

Same procedure as before except pad oscillator at 3. M.C. Trim at 6MC

Rock the gang when making these adjustments.

---

Band #4

Same procedure as before except pad oscillator at 7. MC Trim at 14 MC

Rock the gang when making these adjustments.

---

Band #5

Same procedure as before except pad oscillator at 17. MC trim at 34 MC

Rock the gang while making these adjustments.

It may be necessary to go through the above procedure several times before maximum performance is secured. A small change at one end of each band will affect the other end.

---

When making adjustments on this receiver back off on R.F. gain leaving A.F. gain at maximum at all times.

Be sure and turn the trimmers all the way in (clockwise rotation) (except as noted below) and back out to find the signal, on these air-dielectric trimmers capacity is reduced when turning the screws in a clockwise direction.

---

Detector trimmers on bands 4 & 5 should be backed out all the way and screwed clockwise to find the signal. This will help to eliminate phasing on the wrong side.

Be sure and check images on bands 3, 4, & 5. These images will fall approximately 1. megacycle lower in frequency on all bands.



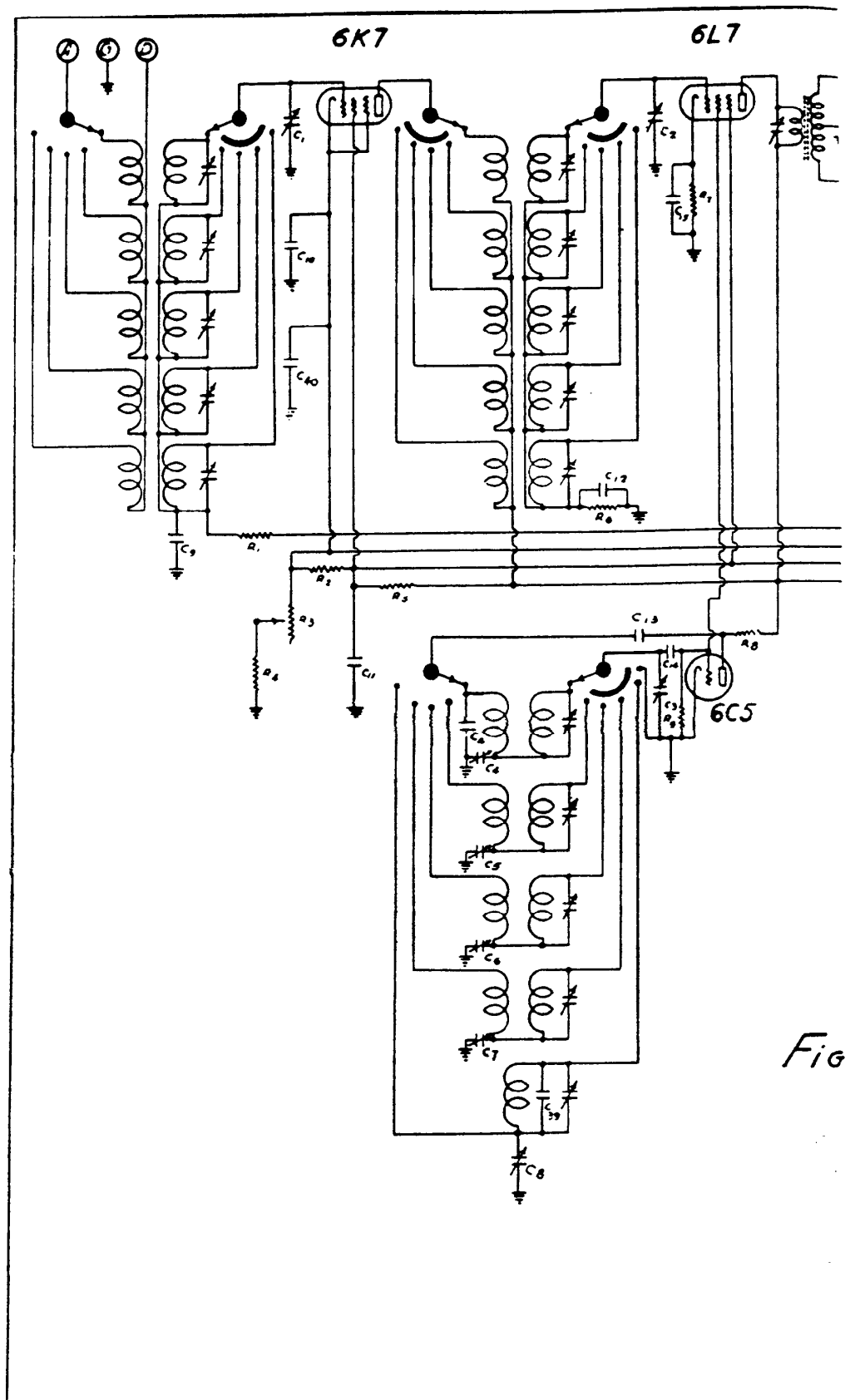

Fig

