

GENERAL DESCRIPTION

This new Hallicrafters radio offers the finest in world-wide radio reception. It features continuous tuning from 540 kilocycles to 44 megacycles for outstanding reception of standard broadcast programs, police, foreign and domestic shortwave broadcasts, amateurs, aircraft, ships and many other exciting distant stations. It receives both voice and code broadcasts and is equipped with a phono socket for playing records through the set.



HALLICRAFTERS MODEL 8R40

92X1652

Good reception is usually possible without an outside antenna or ground and in most localities, fine performance of both standard and shortwave broadcasts can be obtained with the 15 foot antenna wire included with your receiver. It is merely necessary to uncoil this wire, connect one end of it to terminal A1 on the back of the set and then run it about the room in any convenient manner. To complete the antenna installation, connect the jumper between terminals A2 and G on the back of the set.

Your set is provided with two tuning knobs for greater ease of tuning. Wide tuning is done with the

able to hear more stations than you would on ordinary radios with just one tuning knob.

The principal shortwave stations of the world are clearly marked on the dial for your convenience. Since shortwave conditions vary with the season of the year and even with the time of day, shortwave programs may not be heard with the same regularity as standard broadcasts. To determine the most favorable times for shortwave listening, refer to the table provided below.

An Alnico V permanent magnet speaker and full range tone control assure lifelike reproduction of your favorite radio broadcasts and records. If you wish to use an external speaker instead of the one mounted in the cabinet, terminals on the back of the set permit the built-in speaker to be disconnected and an external speaker connected in its place. A jack is provided on the front panel for plugging in a pair of headphones. When the phones are inserted the speaker is automatically disconnected.

A special feature not found in ordinary radios is the SENSITIVITY control on the front panel which permits you to adjust the radio for the strength of each individual station. You will notice when operating the set that the SENSITIVITY control does not have to be turned to maximum for normal reception. This means that you have extra sensitivity available to enable you to pull in weak, distant stations.

The information which follows will assure you greater enjoyment of your Hallicrafters radio. Read it carefully before operating the receiver.

BEST SHORTWAVE RECEPTION TABLE

Band	Most Favorable Time	Most Favorable Distance
6-7 MC	Night - Winter	Day - 400 Miles Night - Over 1500 Miles
9-10 MC	Day - Late Afternoon and Night - Winter	Over 500 Miles
11-12 MC	Evenings or Late Summer Afternoons	Day - Under 1500 Miles Night - Over 1500 Miles
15-18 MC	Early Mornings and Summer Evenings	Over 1500 Miles

INSTALLATION INSTRUCTIONS

POWER SOURCE - This radio is designed to operate from 105 to 130 volt 50/60 cycle alternating current (AC). Do not connect your radio to a wall outlet until certain that the power source is correct for the receiver. If in doubt, telephone your local power company before inserting the plug.

SPEAKER CONNECTION - A built-in speaker has been provided with your receiver, however, a separate external speaker may easily be connected if desired. Terminals marked 1, 2 and 3 are provided on the back of the set for speaker connections. To use the built-in speaker, simply connect the jumper between 2 and 3. To use an external speaker, remove the jumper and connect the speaker to 1 and 2.

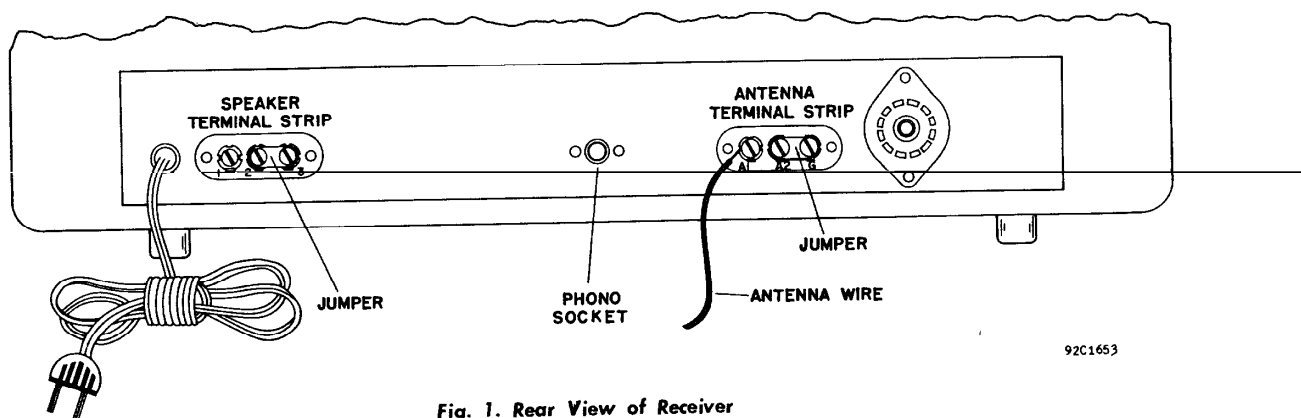

Fig. 1. Rear View of Receiver

ANTENNAS - The terminals marked A1, A2 and G on the back of the set are for antenna and ground connections. Satisfactory reception can be obtained in most localities with merely the 15 foot antenna wire included with your set. The wire should be uncoiled to provide maximum signal pickup. An outside antenna 30 to 60 feet long (ordinary copper wire) may be necessary if the receiver is operated in a difficult reception area or steel constructed building. Connect the antenna to A1 and then connect the jumper between A2 and G. In some locations, reception may be improved by connecting a lead from terminal G to a cold water pipe or other good ground.

For really top performance, there is no substitute for an outside antenna such as used by the commercial radio stations. Provision has been made on your receiver for the connection of this type of antenna, commonly called a doublet. When a doublet antenna is used, the jumper is removed and the antenna is connected to terminals A1 and A2. Consult your radio dealer for further information.

OPERATING INSTRUCTIONS

Each control of this radio receiver performs a definite function which contributes to its outstanding reception capabilities. Full appreciation of your receiver is to be expected only after you have become familiar with each of the

SENSITIVITY CONTROL - Use this control in conjunction with the **VOLUME** control to regulate the volume. The setting of the **SENSITIVITY** control determines the ability of the radio to pick up weak distant stations. Normally this control is set at the maximum position. If the signal is too strong, decrease the sensitivity by turning the control counterclockwise. If, after decreasing the sensitivity, you need more volume use the **VOLUME** control.

BAND SELECTOR CONTROL - Set this control for the band that you wish to tune. The band numbers corresponding to the settings of this control are on the right and left sides of the dial.

VOLUME CONTROL - Turn this control clockwise to turn the set on. Allow about 30 seconds for the tubes to reach operating temperature and then advance the control to increase volume. To turn the set off, turn the control counterclockwise until a click is heard.

OPERATING INSTRUCTIONS (Cont.)

TUNING KNOB - Your receiver has been provided with two tuning knobs - the TUNING knob which operates the large pointer at the top of the dial and a separate BANDSPREAD knob which operates the small pointer at the bottom. The TUNING knob is for wide tuning and the BANDSPREAD knob for fine tuning. Use the TUNING knob to tune in the desired station after you have set the BAND SELECTOR control for the proper band. Tune for the clearest and strongest signal. If the signal is too strong reduce it by means of the VOLUME control, not by using the TUNING knob.

IMPORTANT - The dial readings will correspond to the exact station frequencies only if the BANDSPREAD knob is set so that the small dial pointer reads 0.

BAND SPREAD KNOB - The BANDSPREAD knob permits you to accurately tune in stations on crowded bands by spreading them out so that they can be more easily separated. The BANDSPREAD knob can be used in two different ways. First, it may be left with the small pointer at 5 while you partially tune in the desired station with the TUNING knob. Then, by "rocking" the BANDSPREAD knob back and forth (turn it a few degrees to the left and right through the desired station), you will be able to tune in the desired station with precision accuracy.

The second way to operate the BANDSPREAD knob is to use it to cover a group of stations. Set the BANDSPREAD knob so that the small pointer reads 0 and then turn the TUNING knob to tune in the highest frequency station in the group. The other stations can be heard by slowly turning the BANDSPREAD knob from 0 to 100.

CW-TONE CONTROL - This is a combination CW (code) switch and 3 position tone control. When listening to voice and musical broadcasts or records the control should be set at HIGH, MEDIUM or LOW for the tone most pleasant to the listener. Set this control at CW only if you wish to hear code signals.

PITCH CONTROL KNOB - Use this knob to vary the pitch of CW code signals when listening to amateur or commercial code stations. The CW-TONE control on the front panel must be set at CW for this control to have any effect.

PHONO-RADIO KNOB - Set this knob to radio for reception of radio broadcasts or to PHONO if you wish to play records through the radio.

RECORD PLAYER OPERATION - A phono jack is provided on the back of the set for plugging in a record player. After connecting the player, turn the PHONO-RADIO knob to the PHONO position. Use the VOLUME and CW-TONE controls in the same manner as for radio reception. The remaining controls do not affect record player operation.

SERVICE INSTRUCTIONS

GENERAL SPECIFICATIONS

Tubes and Rectifiers 8 tubes including
one rectifier
Speaker 5-inch PM
Voice Coil Impedance 3.2 ohms
Antenna Provisions Terminals for single wire
or doublet antenna. (See page 3.)
Intermediate Frequency 455 KC
Frequency Coverage 540 KC - 44 MC
Power Supply 105-120 volts 50/60 cycles AC
Power Consumption 75 watts

TUBE AND DIAL LAMP REPLACEMENT - Refer to Fig. 4 for the location of the tubes and dial lamp used in the receiver. The hinged top cover must be raised to gain access to the tubes and dial lamp. When replacing tubes, check the tube type carefully and replace it with the correct type. To replace a tube, insert the center guide pin into the center hole of the tube socket, rotate the tube until the key drops into position and then push down until it is held firmly in the socket. To make a dial lamp replacement, unclip the dial lamp socket from the mounting bracket. Replace the defective lamp with a type 44 pilot lamp.

DIAL CORD STRINGING - The dial drive system of this receiver consists of three separate string drives: (1) TUNING gang drive (2) TUNING pointer drive and (3) BANDSPREAD gang and pointer drive. All stringing should be done with the TUNING and BANDSPREAD gangs fully meshed.

TUNING GANG DRIVE - Tie one end of a 34 inch length of 30 lb. test dial cord to the tie point at position A on pulley (W). Follow the stringing procedure A through E. At position F, place the dial cord through one end of the tension spring. Leave the other end of the spring disconnected and follow the stringing procedure G through K. At position K, take up the slack in the cord and tie it securely to the tie point. As the final step, stretch the tension spring and connect it to the tie point at position L on pulley (X).

TUNING POINTER DRIVE - Tie one end of a 42 inch length of 30 lb. test dial cord to the spring at position 1 on pulley (Z). Follow the stringing procedure 1 through 9. At position 9, stretch the spring and tie the cord securely to the spring. Note that 2-1/4 turns of cord are wrapped around the TUNING drive shaft for proper traction. With the TUNING gang fully meshed, attach the dial pointer to the cord and align it with the left hand index marks on the dial. Cement the pointer to the cord with a drop of quick drying cement.

BANDSPREAD GANG AND POINTER DRIVE - Tie one end of a 41 inch length of 30 lb. test dial cord to the spring at position 1 on pulley (Y). Follow the stringing procedure 1 through 8. At position 8, stretch the spring and tie the cord securely to the spring. Note that 2-1/4 turns of cord are wrapped around the BANDSPREAD drive shaft for proper traction. With the BANDSPREAD gang fully open, attach the dial pointer to the cord and align it with 0 on the BANDSPREAD dial. Cement the pointer to the cord with a drop of quick drying cement.

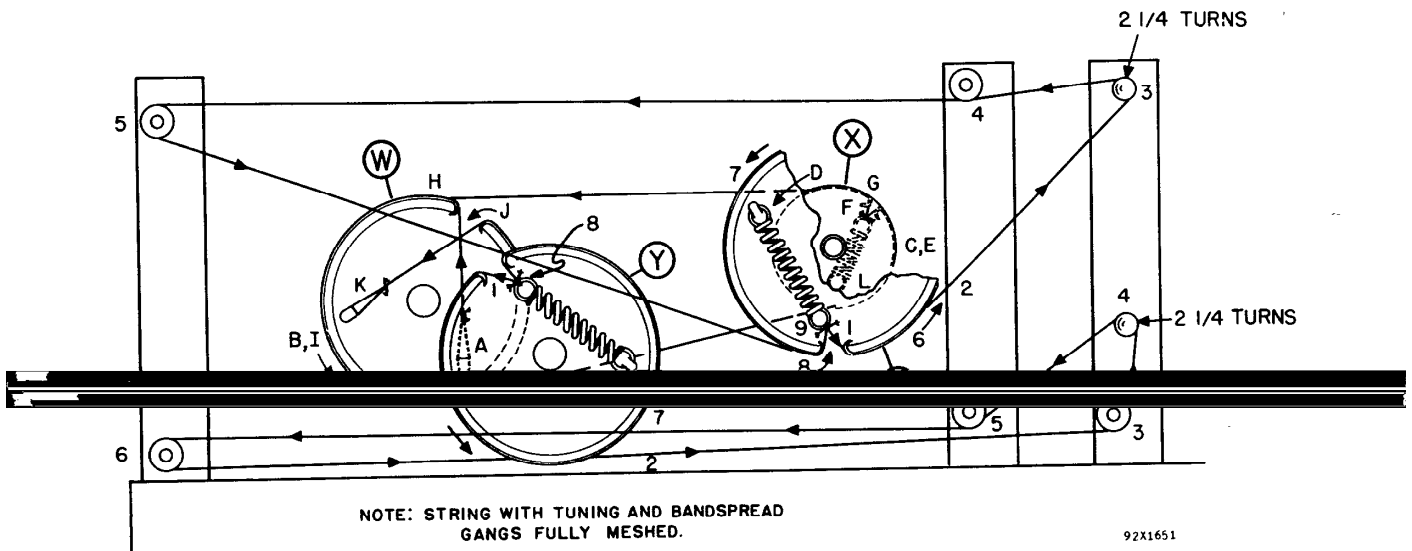

Fig. 2. Dial Cord Stringing Diagram

SERVICE OR OPERATING QUESTIONS - For further operation regarding information or servicing of your radio, contact your dealer. Make no service shipments to the factory as the Hallicrafters Co. will not accept the responsibility for unauthorized shipments. Factory type service is available at any HALLICRAFTERS AUTHORIZED SERVICE CENTER which displays the sign shown at the right of the page. For the location of the one nearest you, consult your dealer or telephone directory.



The Hallicrafters Co. reserves the privilege of making revisions in current production of equipment and assumes no obligation to incorporate these revisions in earlier models.

92X1401-R

ALIGNMENT INSTRUCTIONS

- Be sure both the set and signal generator are thoroughly warmed up before starting alignment.
- Use an amplitude modulated generator covering 455 KC to 36 MC. Use a modulated output for every step except Step 2.
- Connect an output meter across the speaker voice coil.
- Use a non-metallic alignment tool.
- Set the VOLUME, SENSITIVITY and BANDSPREAD controls fully clockwise, CW-TONE control at HIGH and the PHONO-RADIO knob at RADIO.
- Refer to Figs. 4 and 5 for location of alignment adjustments.

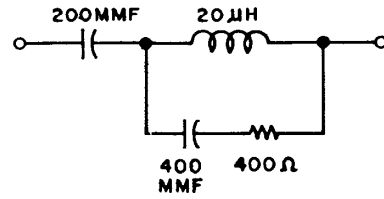

92A1549
Fig. 3. RMA Dummy Antenna

Step	Signal Generator Connections	Generator Frequency	Band Selector Setting	Receiver Dial Setting	Adjust
IF ALIGNMENT					
1	High side to stator plates of center section of TUNING gang. Low side to chassis.	455 KC	1	1000 KC	A, B, C, D, E and F for max. output. Keep reducing gen. output so that the output meter reading does not exceed 50 milliwatts.
CW PITCH CONTROL ADJUSTMENT					
2	Same as Step 1.	455 KC (No Mod.)	1	1000 KC	Set the CW-TONE control to CW. Remove the PITCH CONTROL knob and adjust G for a zero beat. Replace the knob with the dot in the top center position. After completing Step 2, reset the CW-TONE control to HIGH.
RF ALIGNMENT					
3	High side thru RMA dummy antenna (Fig. 3) to terminal A1 on back of chassis. Low side to chassis. Connect the jumper between A2 and G.	36 MC	4	36 MC	H, I and J for maximum output as in Step 1.
		18 MC	4	18 MC	K, L and M for maximum output as in step 1.
4	Same as Step 3.	14 MC	3	14 MC	N, O and P for maximum output as in Step 1.
		10 MC	3	10 MC	Q, R, and S for maximum output as in Step 1.
5	Same as Step 3.	5 MC	2	5 MC	T, U and V for maximum output as in Step 1.
		1.8 MC	2	1.8 MC	W for maximum output as in Step 1.
6	Same as Step 3.	1500 KC	1	1500 KC	X, Y and Z for maximum output as in Step 1.
		600 KC	1	600 KC	Z" for maximum output as in Step 1.

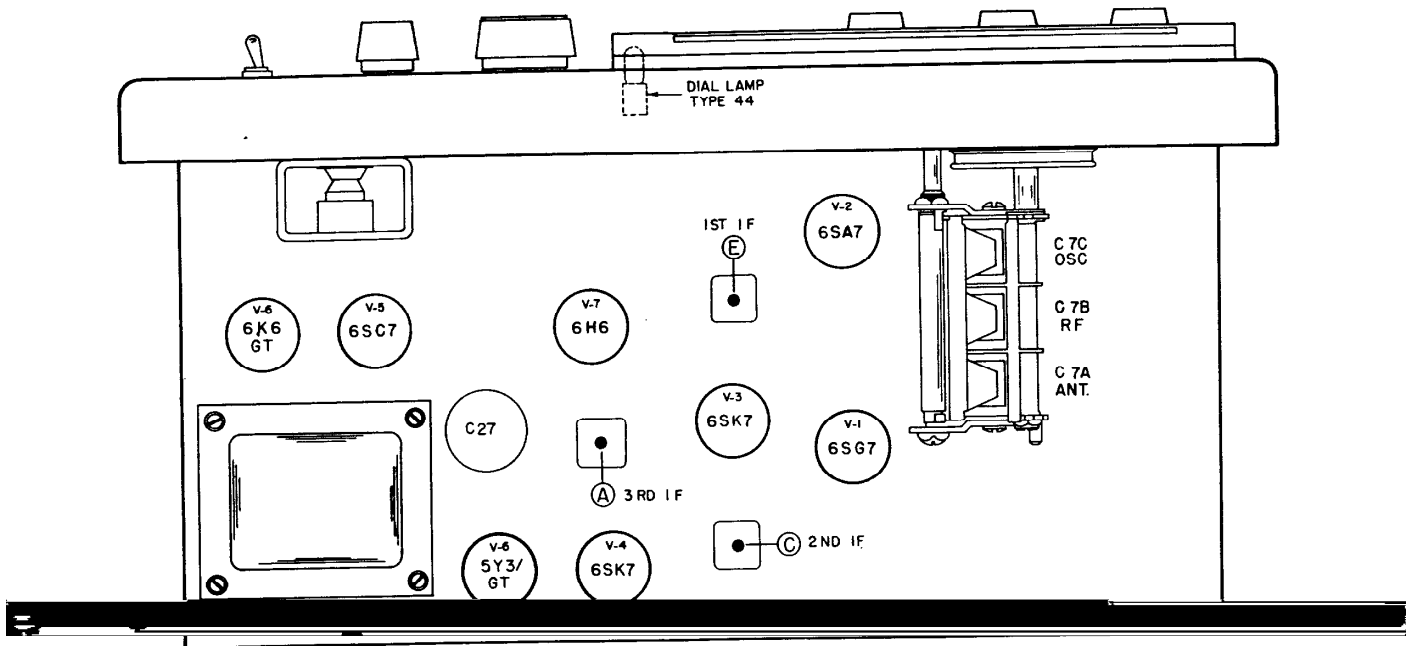

Fig. 4. Top View of Chassis Showing Location of Alignment Adjustments, Tubes and Dial Lamp

92C1654-A

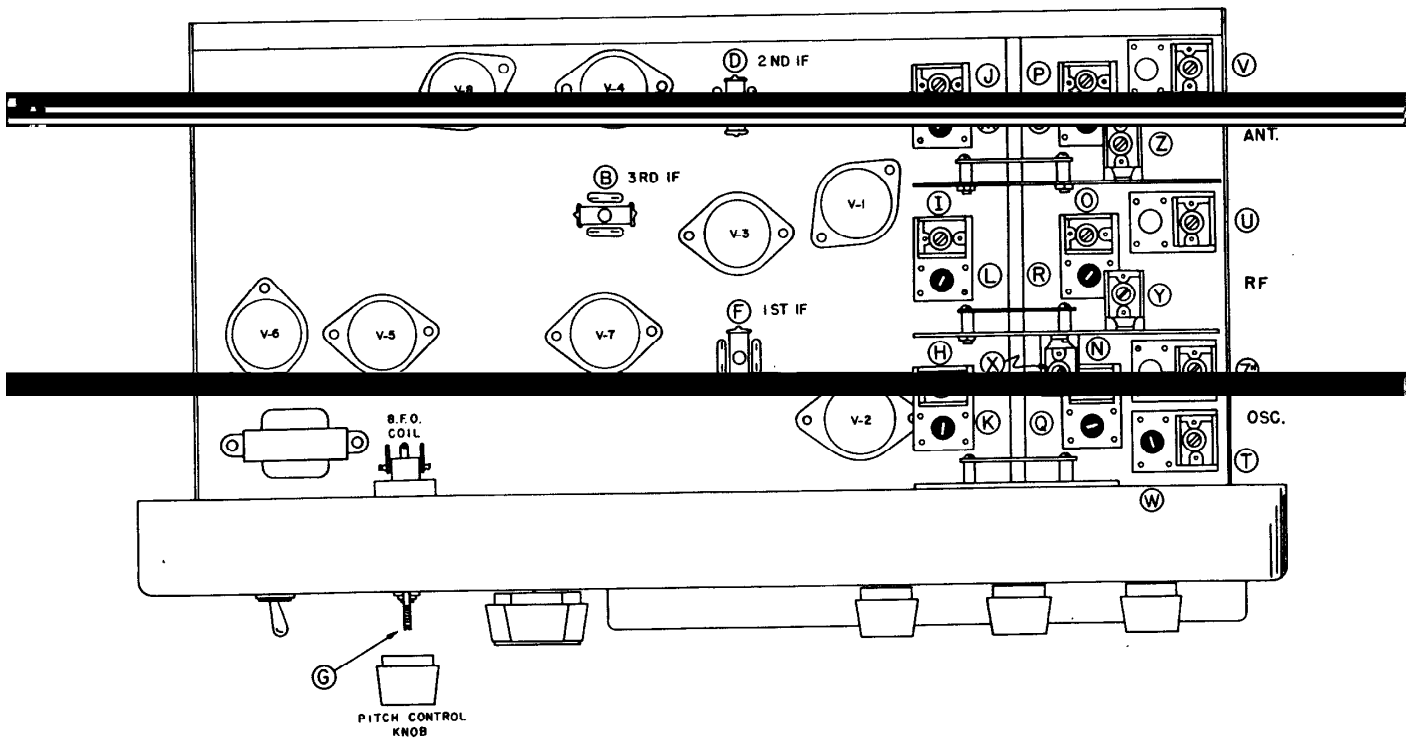

Fig. 5. Bottom View of Chassis Showing Location of Alignment Adjustments

92D1628-A

SERVICE PARTS LIST

Schematic Symbol	Description	Hallcrafters Part Number	Schematic Symbol	Description	Hallcrafters Part Number
CAPACITORS					
C-1,2,3,12,13,14,19,20,21	Trimmers; part of coils L-1,2,3,4,5,6,7,8 and 9 respectively	-----	L-10	Coil, oscillator; band 1	51B912
C-4,15,22	Trimmer, 1.5-15 mmf.	44A191	L-11	Coil, BFO	54B044
C-7A, B and C	Tuning capacitor, 3 section	•48C281 or •48C291	T-1,2	Transformer, 1st and 2nd IF	50C243
C-8,32,35,58	.05 mfd. 200 V., tubular	46A U503J	T-3	Transformer, IF; detector stage	50C242
C-9,28	.05 mfd. 600 V., tubular	46A Y503J	T-4	Transformer, audio output	55B093
C-10	22 mmf. 500 V., ceramic	47X21UK220M	T-5	Transformer, power	52C209
C-11	15 mmf. 500 V., ceramic	47X21UK150M	SWITCHES		
C-16	390 mmf. 500 V., mica	47X20B391K	S-1A	Switch wafer, BAND SELECTOR; antenna stage	•60B389 or •62B070
C-17,53	.01 mfd. 600 V., tubular	46A Y103J	S-1B	Switch wafer, BAND SELECTOR; RF stage	•62B039 or •62B072
C-18	68 mmf. 500 V., ceramic	47X25UK680K	S-1C	Switch wafer, BAND SELECTOR; oscillator stage	•62B044 or •62B071
C-23	3000 mmf. 500 V., mica	47X30C302K	S-2	Switch, toggle (s.p.d.t.); PHONO-RADIO	60A139
C-24	1500 mmf. 500 V., mica	47X30C152J	S-3A,B & C	Switch, CW-TONE	60B469 or 60B486
C-25	Padder; part of coil L-10	-----	S-4	Switch, OFF-ON; part of VOLUME control R-20	-----
C-27A,B & C	30-10-10 mfd. 450 V., electrolytic	45A062	Shaft and index plate, BAND SELECTOR		
C-29,33	220 mmf. 500 V., mica	47X20B221K	PLUGS AND SOCKETS		
C-31,43	.02 mfd. 200 V., tubular	46A U203J	J-1	Jack, PHONES	36A002
C-38	2 mmf., twisted wire assembly	-----	J-2	Jack, PHONO	36A029
C-39	.1 mfd. 600 V., tubular	46A Y104J	PL-1	Line cord and plug	87B1573
C-41,42	47 mmf. 500 V., mica	47X20B470M	SO-1	Socket assembly, phono motor (model 8R40C)	87B1901
C-44,55	270 mmf. 500 V., mica	47X20B271K	Socket, tube, octal		
C-45,48,52,53	.02 mfd. 600 V., tubular	46A Y203J	TUBES AND DIAL LAMPS		
C-47	.002 mfd. 1000 V., tubular	46A104	V-1	6SG7: RF amplifier	90X6SG7
C-54	470 mmf. 500 V., mica	47X20B471J	V-2	6SA7: converter	90X6SA7
C-56	.01 mfd. 600 V., molded tubular	46A C103J	V-3,4	6SK7: 1st and 2nd IF amplifiers	90X6SK7
C-57	1000 mmf. 500 V., mica	47X25B102M	V-5	6SC7: BFO and audio amplifier	90X6SC7
C-61	25 mfd. 200 V., tubular	46A T254J	V-6	6K8GT: audio output	90X6K8GT
C-62	2.2 mmf. 500 V., bakelite gimmick	47A160-4	V-8	5Y3GT; rectifier	90X5Y3GT
C-64	10 mfd. 25 V., electrolytic	45A121	LM-1	Lamp, dial; type 44	39A003
RESISTORS					
R-1	1 megohm 1/2 watt, carbon	23X20X105K	MISCELLANEOUS PARTS		
R-2	120 ohms 1/2 watt, carbon	23X20X121K	Background, dial; paper		
R-3	10,000 ohms, SENSITIVITY control	-----	Bracket, mtg; front (for mtg tuning capacitor)		
R-4,31,35	27 ohms 1/2 watt, carbon	23X20X270K	Bracket, mtg; rear (for mtg tuning capacitor)		
R-5	39,000 ohms 1 watt, carbon	23X30X393K	Cabinet (does not include front panel or top cover)		
R-6,26	6800 ohms 1 watt, carbon	23X30X682K	Clip, IF mtg		
R-7	18,000 ohms 1/2 watt, carbon	23X20X183K	Cord, dial (specify length)		
R-8	10,000 ohms 2 watts, carbon	23X40X103K	Dial		
R-9	470 ohms 1/2 watt, carbon	23X20X471K	Dial light assembly		
R-10	8200 ohms 2 watts, carbon	23X40X822K	Escutcheon		
R-11,18,65	1000 ohms 1/2 watt, carbon	23X20X102K	Foot, mtg.; rubber		
R-12	2.2 megohms 1/2 watt, carbon	23X20X225K	Glass, escutcheon		
R-14	47,000 ohms 1/2 watt, carbon	23X20X473K	Iron core; for coils L-1,2,4,5,7,8 and 9		
R-20	500,000 ohms, VOLUME control	25B605	Knob, SENSITIVITY, BAND SELECTOR, VOLUME and CW-TONE		
R-21	150 ohms 1/2 watt, carbon	23X20X151K	Knob, PITCH CONTROL		
R-22	270,000 ohms 1/2 watt, carbon	23X20X274K	Knob, TUNING and BANDSPREAD		
R-23,69	470,000 ohms 1/2 watt, carbon	23X20X474K	Lock, line cord; male section		
R-24	680 ohms 1 watt, carbon	23X20X681K	Lock, line cord; female section		
R-25	15,000 ohms 1 watt, carbon	23X30X153K	Panel, front		
R-27,66	47,000 ohms 1 watt, carbon	23X30X473K	Pointer, dial; TUNING		
R-28	22,000 ohms 1/2 watt, carbon	23X20X223K	Pointer, dial; BANDSPREAD		
R-29,58	100,000 ohms 1/2 watt, carbon	23X20X104K	Speaker, 5-inch PM		
R-30,68	10 ohms 1/2 watt, carbon	23X20X100K	Spring, dial; 11/16"		
R-32	1500 ohms 10 watts, wirewound	24BG152E	Spring, dial; 25/64"		
R-33	15 megohms 1/2 watt, carbon	23X20X156K	Terminal strip, antenna		
R-34	10,000 ohms 1/2 watt, carbon	23X20X103K	Terminal strip, speaker		
R-63	6.8 ohms 1 watt, carbon	23X30X068K	Top, cabinet		
R-64	330 ohms 1/2 watt, carbon	23X20X331K			
R-67	330,000 ohms 1/2 watt, carbon	23X20X334K			
COILS AND TRANSFORMERS					
L-1	Coil, antenna; band 4	51B783			
L-2	Coil, antenna; band 3	51B782			
L-3	Coil, antenna; bands 1 and 2	51B1241			
L-4	Coil, RF; band 4	51B787			
L-5	Coil, RF; band 3	51B786			
L-6	Coil, RF; bands 1 and 2	51B1240			
L-7	Coil, oscillator; band 4	51B791			
L-8	Coil, oscillator; band 3	51B913			
L-9	Coil, oscillator; band 2	51B789			

- When tuning capacitor 48C281 is used, brackets 67A555 and 67A671 must be used in conjunction with it.
- When tuning capacitor 48C291 is used, brackets 67A556 and 67A678 must be used in conjunction with it.
- Switch wafers 60B389, 62B039 and 62B044 can be used only in conjunction with shaft and index plate 60B392.
- Switch wafers 62B070, 62B072 and 62B071 can be used only in conjunction with shaft and index plate 60B485.

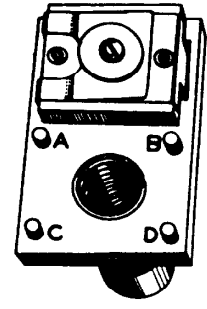
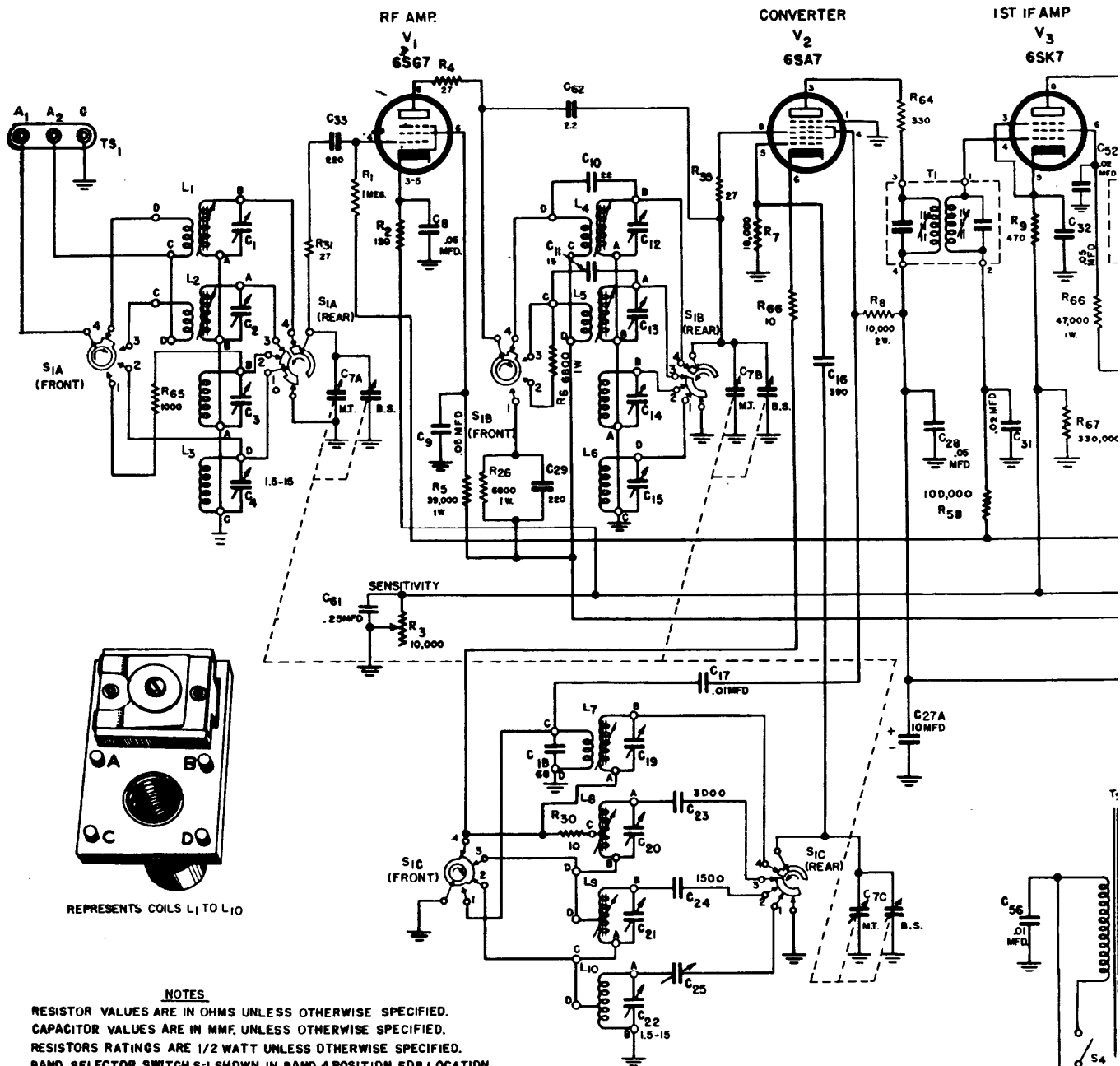

REPRESENTS COILS L₁ TO L₁₀

NOTES

RESISTOR VALUES ARE IN OHMS UNLESS OTHERWISE SPECIFIED.
 CAPACITOR VALUES ARE IN MMF. UNLESS OTHERWISE SPECIFIED.
 RESISTOR RATINGS ARE 1/2 WATT UNLESS OTHERWISE SPECIFIED.
 BAND SELECTOR SWITCH S-1 SHOWN IN BAND 4 POSITION. FOR LOCATION
 OF SWITCH SECTIONS, SEE FIG. 6.

VALUES AND TOLERANCES SHOWN ARE NOMINAL AND VARIATIONS MAY BE FOUND.
 IT IS RECOMMENDED THAT THE VALUE OF ANY REPLACEMENT CORRESPOND
 TO THE NOMINAL VALUE OF THE PART BEING REPLACED.

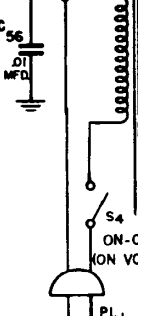

105-125V. 50/60"

MODEL 8R40

RUN 2

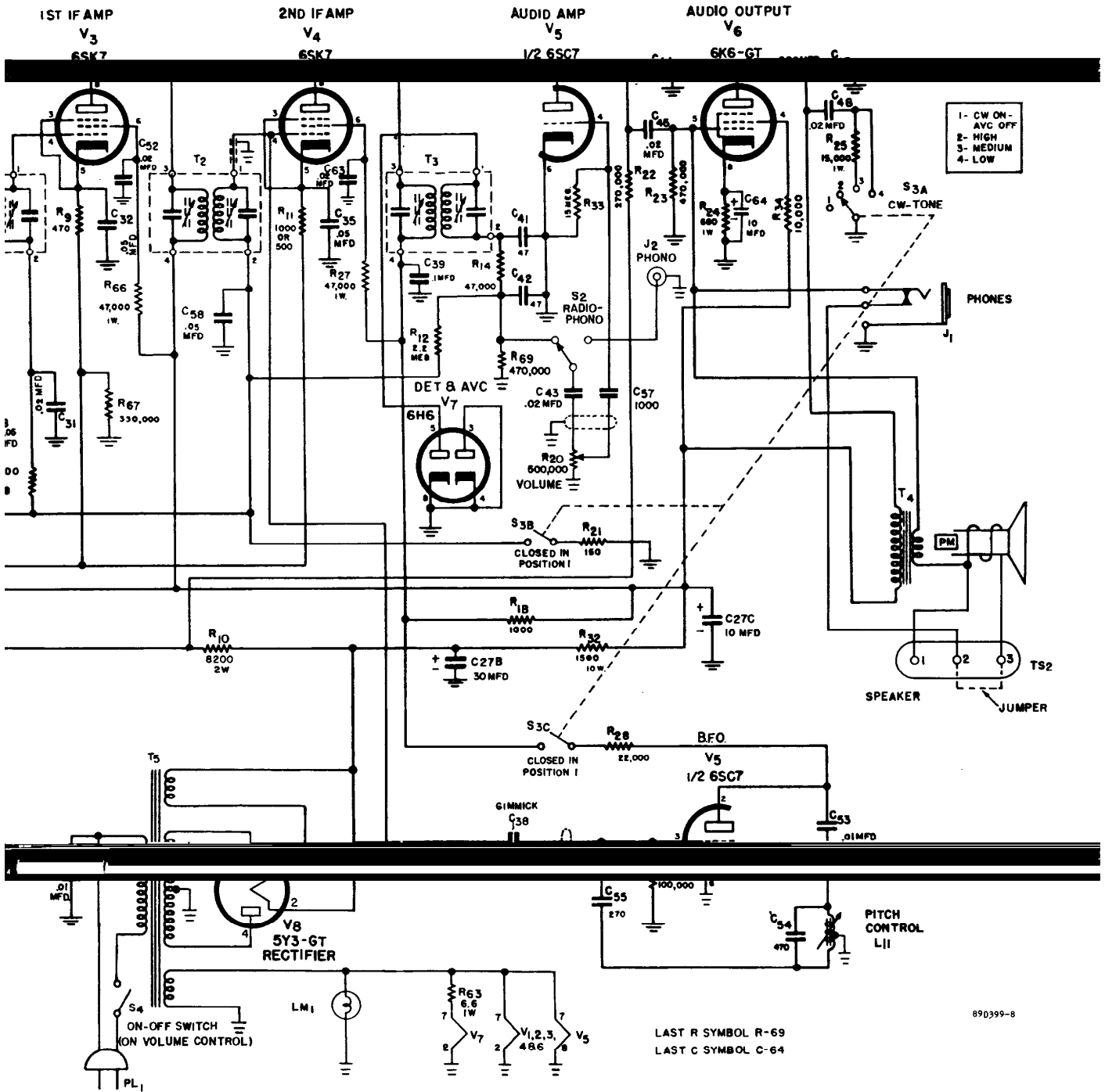

890399-8

