

KENWOOD

HF TRANSCEIVER

TS-950SDX

INSTRUCTION MANUAL

KENWOOD CORPORATION

© PRINTED IN JAPAN B62-0229-20(K, M, E, E2, P, X)(MC)
93/12 11 10 9 8 7 6 5 4 3 2 1 92/12 11 10 9 8 7 6

Downloaded by
Amateur Radio Directory

Thank you for purchasing this new transceiver.

IMPORTANT

Please read this Instruction Manual carefully before placing the transceiver in service.

SAVE THIS INSTRUCTION MANUAL.

The following explicit definitions apply in this manual:

Note : If disregarded, inconvenience only, no risk of equipment damage or personal injury.

Caution : Equipment damage may occur, but not personal injury.

This Instruction Manual covers the following models:

TS-950SDX: HF TRANSCEIVER with the , SO-2, YK-88C-1, YG-455C-1, and YG-455S-1, are included in this transceiver as standard equipment.

FCC WARNING

This equipment may generate or use radio frequency energy. Changes or modifications to this equipment may cause harmful interference unless the modifications are expressly approved in the instruction manual. The user could lose the authority to operate this equipment if an unauthorized change or modification is made.

Note

This equipment has been tested and found to comply with the limits for a Class B digital device, pursuant to Part 15 of the FCC Rules. These limits are designed to provide reasonable protection against harmful interference in a residential installation. This equipment may cause harmful interference to radio communications, if it is not installed and used in accordance with the instructions. However, there is no guarantee that interference will not occur in a particular installation. If this equipment does cause harmful interference to radio or television reception, which can be determined by turning the equipment off and on, the user is encouraged to

CONTENTS





1. BEFORE OPERATION	3
2. SPECIFICATIONS AND ACCESSORIES.....	5
2-1. SPECIFICATIONS.....	5
2-2. ACCESSORIES	6
3. INSTALLATION AND CONNECTION	7
3-1. INSTALLATION	7
3-2. CONNECTION	7
4. OPERATION	10
4-1. OPERATING CONTROLS	10
4-2. RECEIVER OPERATION	21
4-3. TRANSMITTER OPERATION	31
4-4. MEMORY	38
4-5. SCAN	42
4-6. CW message function	44
4-7. Voice Recording using the DRS function	45
4-8. REPEATER OPERATION.....	47
4-9. OPERATION WITH A PERSONAL COMPUTER	47
4-10. VOICE SYNTHESIZER	48
4-11. DIGITAL MODULATION FUNCTION ...	48
4-12. Transfer function when two TS-950SDX transceivers are connected together ..	49
4-13. When used as the master machine for the transverter	51
5. MAINTENANCE AND ADJUSTMENTS	52
5-1. GENERAL INFORMATION	52
5-2. SERVICE	52
5-3. CLEANING	52
5-4. IN CASE OF DIFFICULTY	53
5-5. ORDERING SPARE PARTS.....	54
5-6. ADJUSTMENTS	54
6. OPTIONAL ACCESSORIES	58
6-1. DRU-2 DIGITAL RECORDING UNIT INSTALLATION	58
6-2. OPTION FILTER INSTALLATION.....	58
6-3. VS-2 VOICE SYNTHESIZER INSTALLATION	59
6-4. OTHER ACCESSORIES.....	60
7. REFERENCE.....	62

increase the separation between the equipment and receiver.

- Connect the equipment into an outlet on a circuit different from that to which the receiver is connected.
- Consult the dealer or an experienced radio/TV technician for help.

Safety precautions

WARNING: TO PREVENT FIRE OR ELECTRIC SHOCK, DO NOT EXPOSE THIS APPLIANCE TO RAIN OR MOISTURE.

	<p>CAUTION RISK OF ELECTRIC SHOCK DO NOT OPEN</p>		<p>CAUTION: TO REDUCE THE RISK OF ELECTRIC SHOCK, DO NOT REMOVE COVER (OR BACK). NO USER-SERVICEABLE PARTS INSIDE. REFER SERVICING TO QUALIFIED SERVICE PERSONNEL.</p>
	<p>THE LIGHTNING FLASH WITH ARROWHEAD SYMBOL, WITHIN AN EQUILATERAL TRIANGLE, IS INTENDED TO ALERT THE USER TO THE PRESENCE OF UNINSULATED "DANGEROUS VOLTAGE" WITHIN THE PRODUCT'S ENCLOSURE THAT MAY BE OF SUFFICIENT MAGNITUDE TO CONSTITUTE A RISK OF ELECTRIC SHOCK TO PERSONS.</p>		
	<p>THE EXCLAMATION POINT WITHIN AN EQUILATERAL TRIANGLE IS INTENDED TO ALERT THE USER TO THE PRESENCE OF IMPORTANT OPERATING AND MAINTENANCE (SERVICING) INSTRUCTIONS IN THE LITERATURE ACCOMPANYING THE APPLIANCE.</p>		

IMPORTANT SAFEGUARDS

Caution : Read this page carefully to ensure safe operation

Please read all of the safety and operating instructions before operating this unit. For best results, follow all warnings placed on the unit and adhere to the operating and use instructions. These safety and operating instructions should be retained for future reference.

- 1. Power sources** — The unit should be connected to a power supply only of the type described in the operating instructions or as marked on the appliance.
- 2. Power-cord protection** — Power-supply cords should be routed so that they are not likely to be walked on or pinched by items placed upon or against them, pay particular attention to cords at plugs, convenience receptacles, and the point where they exit from the unit.

Never pull or stretch the cord.



- 3. Abnormal smell** — If an abnormal smell or smoke is detected, immediately turn the power OFF and pull out the power cord. Contact your dealer or nearest service center.

POWER OFF!

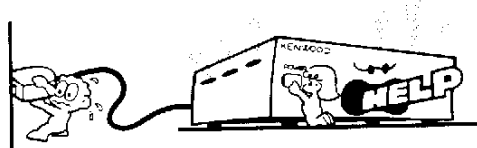

- 4. Electric shock** — Care should be taken so that objects do not fall and liquid is not spilled into the enclosure through openings. If a metal object, such as a hair pin or a needle, comes into contact with the inside of this unit, a dangerous electric shock may result. For families with children, never permit children to put anything, especially metal, inside this unit.

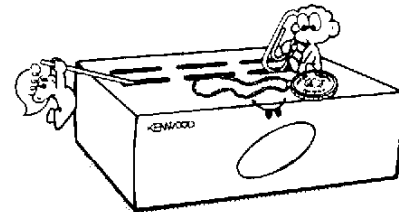

- 5. Grounding or polarization** — The precautions should be taken so that the grounding or polarization means of this unit is not defeated.

- 6. Ventilation** — The unit should be situated so that its location or position does not interfere with its proper ventilation.

To maintain good ventilation, do not put records or a table-cloth on the unit. Place the unit at least 4 inches (10 cm) away from the walls.

Do not use the unit on a bed, sofa, rug or similar surface that may block the ventilation openings.

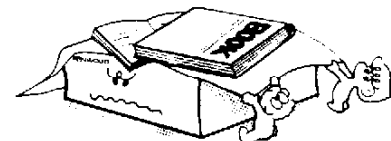

⚠ Caution : Read this page carefully to ensure safe operation.

- 7. Enclosure removal** — Never remove the enclosure. If the internal parts are touched accidentally, a serious electric shock might occur.

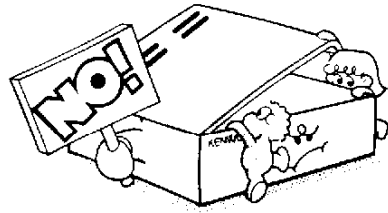

- 8. Water and moisture** - The unit should not be used near water — for example, near a bathtub, washbowl, kitchen sink, laundry tub, in a wet basement, or near a swimming pool, etc.

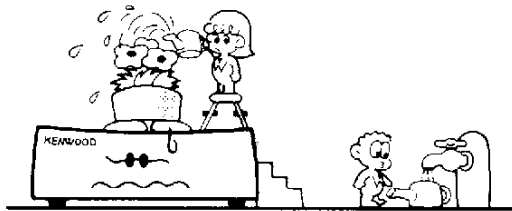

- 11. Heat** — The unit should be situated away from heat sources such as radiators, heat registers, stoves, or other units (including amplifiers) that produce heat.

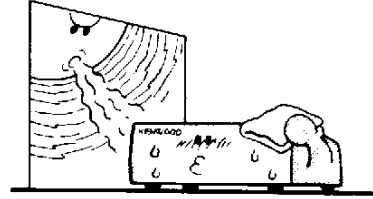

- 12. Cleaning** — Do not use volatile solvents such as alcohol, paint thinner, gasoline, or benzine, etc. to clean the cabinet. Use a clean dry cloth.

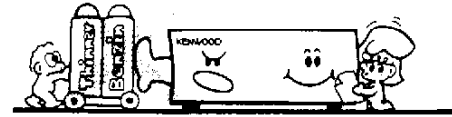

- 13. Nonuse periods** — The power cord of the unit should be unplugged from the outlet when left un-

protected against voltage surges and built up static charges. Section 810 of the National Electrical Code, ANSI/NFPA 70, provides information with respect to proper grounding of the mast and supporting structure, grounding of the lead-in wire to an antenna discharge unit, size of grounding conductors, location of antenna-discharge unit, connection to grounding electrodes, and requirements for the grounding electrode. See the accompanying illustration.

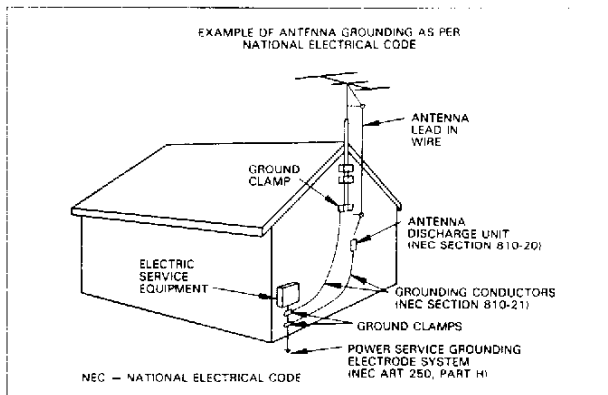

- 10. Power lines** — An outdoor antenna should be lo-

- 14. Servicing** — The user should not attempt to service the unit beyond that described in the operating instructions. All other servicing should be referred to qualified service personnel.

- 15. Damage requiring service** — The unit should be serviced by qualified service personnel when:

- A.** The power-supply cord or the plug has been damaged; or
- B.** Objects have fallen, or liquid has been spilled into the unit; or
- C.** The unit has been exposed to rain; or
- D.** The unit does not appear to operate normally or exhibits a marked change in performance; or
- E.** The unit has been dropped, or the enclosure damaged.

2. SPECIFICATIONS AND ACCESSORIES

2-1. SPECIFICATIONS

General		Transmitter-B	
Mode	J3E (LSB, USB) A1A(CW), A3E(AM) F3E(FM) F1A(FSK)	Modulation	SSB Balanced modulation. FM Reactance modulation. AM Low level modulation.
Memory Channels	100 Channels.	Spurious radiation	Less than -40dB
Antenna impedance	50 ohms. (With Antenna Tuner 20~150 ohms.)	Carrier suppression(with 1.5kHz reference.)	More than 50dB
Power requirement	K and P type (120VAC±10%) M type (120/230VAC±10%) E type (230VAC±10%) T type (220/240VAC±10%) X type (120/240VAC±10%)	Unwanted sideband suppression (with 1.5kHz reference)	More than 60dB.
Power dissipation		Maximum frequency deviation (FM)	Less than ±5kHz.
Receive mode with no input signal	110W	Frequency response (-6dB)	100 to 3100Hz.
Transmit mode	700W (7.5A)	XIT variable range	±9.99kHz.
Operating temperature	-10 to +50°C (+14 to +122°F)	Microphone impedance	250 ohms to 600 ohms.
Frequency stability	Less than ±0.5 PPM.		
Frequency accuracy	Less than ±0.5 PPM.		
Dimensions (W×H×D)	409×154×446mm (Projections included 16-3/22"×6-1/16"×17-9/16")		
Weight	23kg (50.6lbs)		
Transmitter-A		Receiver-A	
Frequency range		Circuitry	
160m band	1.8 to 2.0 MHz	Main SSB, CW, FSK, AM	Quadruple conversion superheterodyne.
80m band	3.5 to 4.0 MHz	FM	Triple conversion superheterodyne.
40m band	7.0 to 7.3 MHz	Sub SSB, CW, FSK	Double conversion superheterodyne.
30m band	10.1 to 10.15 MHz	Frequency range	100kHz to 30MHz.
20m band	14.0 to 14.35 MHz	Intermediate frequency	
17m band	18.068 to 18.168 MHz	Main 1st	73.05MHz
15m band	21.0 to 21.45 MHz	2nd	8.83MHz
12m band	24.89 to 24.99 MHz	3rd	455kHz
10m band	28.0 to 29.7 MHz	4th	100kHz
Output Power		Sub 1st	40.055MHz
(With auto antenna tuner in "THRU").		2nd	10.695MHz
1.9~24MHz SSB, CW, FSK, FM	150W (MAX) 20W (MIN)	Sensitivity	
AM	40W (MAX) 10W (MIN)	SSB, CW (at 10dB S + N/N)	
28MHz SSB, CW, FSK, FM	110W (MAX) 20W (MIN)	100kHz~150kHz	Less than 2.5 μV
AM	40W (MAX) 10W (MIN)	150kHz~490kHz	Less than 1 μV
		490kHz~1.62MHz	Less than 4 μV
		1.62MHz~30MHz	Less than 0.2 μV
		AM(at 10dB S + N/N)	
		100kHz~150kHz	Less than 25 μV
		150kHz~490kHz	Less than 10 μV
		490kHz~1.62MHz	Less than 32 μV
		1.62MHz~30MHz	Less than 2.0 μV
		FM(at 12dB SINAD)	
		28MHz~30MHz	Less than 0.5 μV
		Note	
		USA version only :	
		490kHz~1.62MHz →	490kHz~1.705MHz
		1.62MHz~30MHz →	1.705MHz~30MHz

Downloaded by

Amateur Radio Directory

Receiver-B

Selectivity	
SSB, AM(N), FSK	-6dB : 2.4kHz -60dB : 3.4kHz
AM(W)	-6dB : 6kHz -50dB : 15kHz
CW(W)	-6dB : 400Hz -60dB : 900Hz
FM	-6dB : 12kHz -60dB : 24kHz

Image ratio	More than 80dB.
1st IF rejection	More than 70dB.
Notch filter attenuation	More than 45dB.
RIT variable range	±9.99kHz

Squelch sensitivity	
SSB, CW, FSK, AM	
100kHz~150kHz	Less than 6.3 μV
150kHz~490kHz	Less than 2.5 μV
490kHz~1.62MHz	Less than 10 μV
1.62MHz~30MHz	Less than 0.5 μV
FM 28MHz~30MHz	Less than 0.32 μV

Note

USA version only :

490kHz~1.62MHz	→ 490kHz~1.705MHz
1.62MHz~30MHz	→ 1.705MHz~30MHz

Output	1.5W across 8 ohms load. (10% distortion)
Output load impedance	8 ohms.

Notes

1. Circuit and ratings are subject to change without notice due to advancements in technology.
2. Remember to keep the transmitting output power within the power limitations of your license.

2-2. ACCESSORIES

Unpack your TS-950SDX carefully and confirm that it is supplied with the following accessories.

Quick Key Board (RM-1)	X60-3240-00	1 ea.
Dynamic microphone	T91-0352-15	1 ea.
DIN plug (7-pin)	E07-0751-05	1 ea.
DIN plug (13-pin)	E07-1351-05	1 ea.
Fuse (6A)(M type only)	F05-6021-05	1 ea.
Control location sticker	B42-3371-04	1 ea.
Instruction Manual	B62-0229-XX	1 copy.
External control Instruction Manual	B62-0233-XX	1 copy.
Circuit Diagram	B62-0264-XX	1 copy.
MENU KEY DISPLAY LIST	B59-0456-XX	1 copy.
Warranty card	(U.S.A., Canada and Europe version only)		1 ea.

Attach the control location sticker on the upper case where it can be easily seen .

After unpacking

Shipping container:

Save the boxes and packing in the event your unit needs to be transported for remote operation, maintenance, or service.

For United Kingdom

The mains plug must be removed from the wall socket prior to any internal examination.

WARNING : THIS APPARATUS MUST BE EARTHED.

Important : The wires in this mains lead are coloured in accordance with the following code:

Blue	Neutral
Brown	Live
Green-and-Yellow	..	Earth

The wires in this mains lead must be connected to the terminals in the plug as follows:

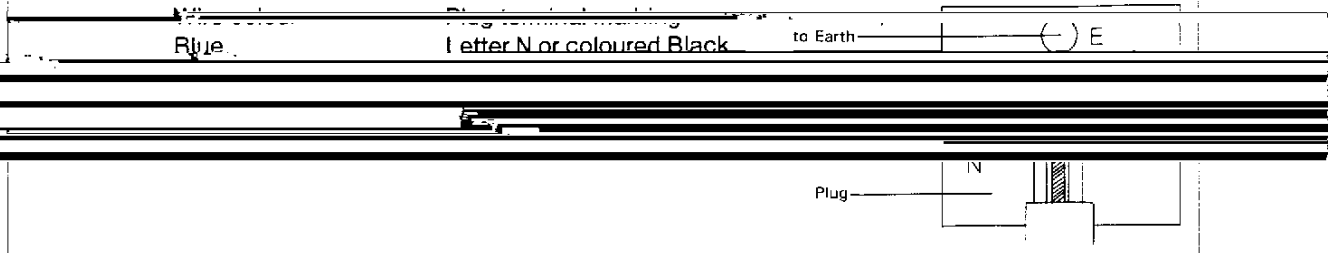

3. INSTALLATION AND CONNECTION

3-1. INSTALLATION

FRONT FEET

By extending the front feet, the front panel can be elevated for operating convenience. Turn the front feet left and pull down. Then turn right to lock.

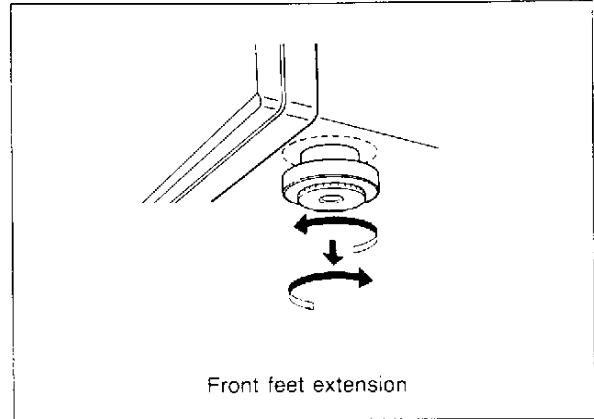

3-2. CONNECTION

The TS-950SDX is supplied to operate from a 120V AC, 220V AC or 240V AC 50/60 Hz power source capable of supplying 700 watts or more.

Note

U.S.A. versions of this radio are equipped with a non-switchable 120VAC 60Hz power supply.

A. Rear Panel

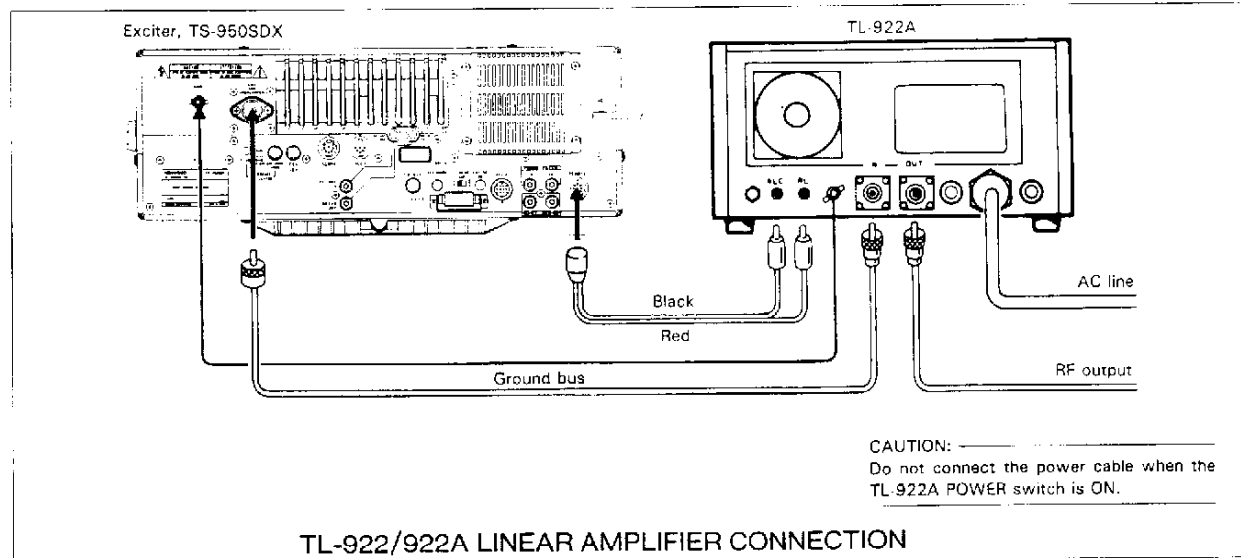
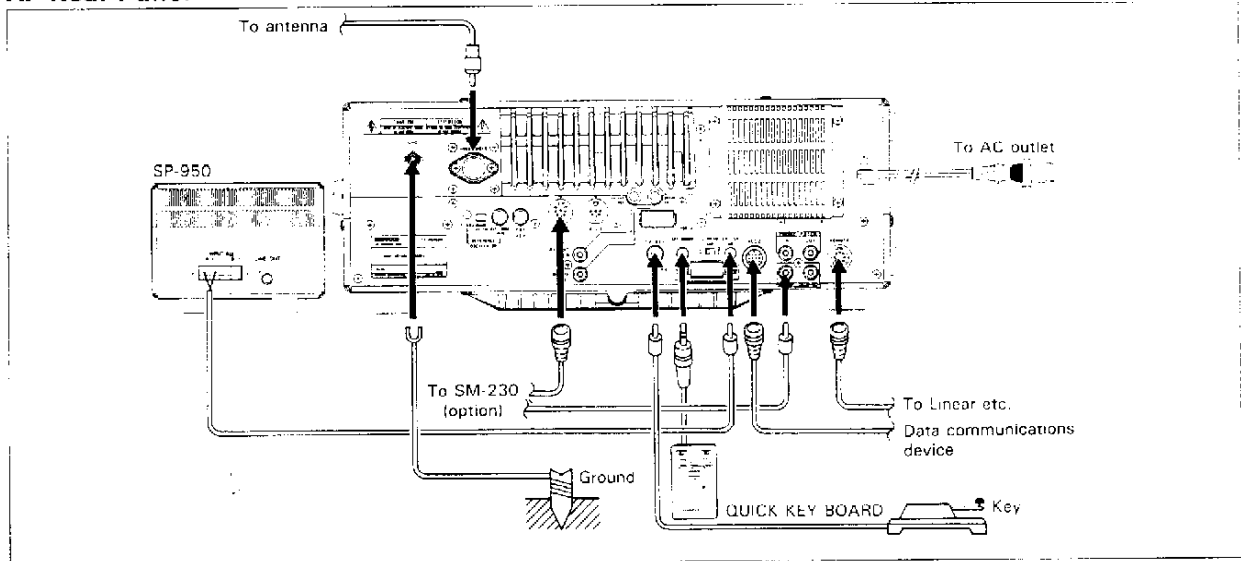

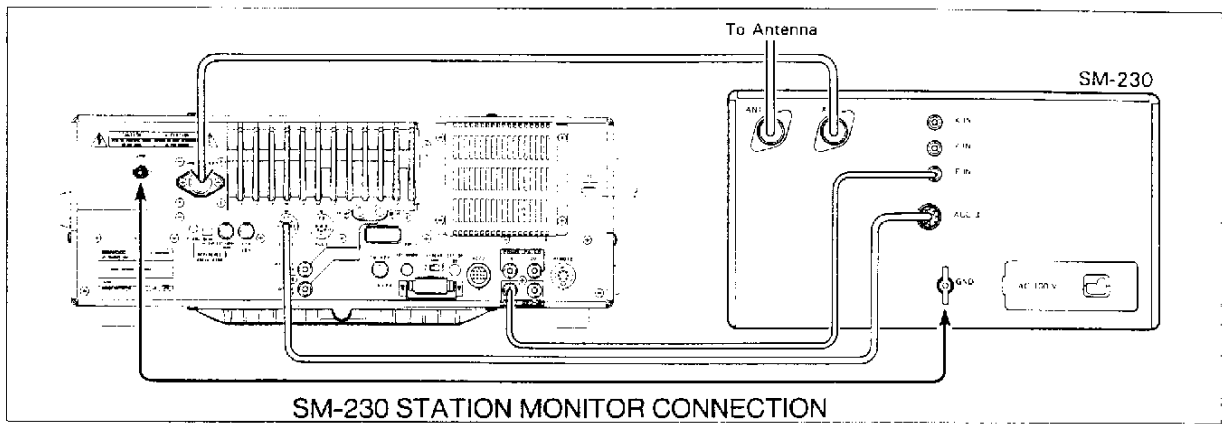

(1) Antenna

Caution
Protect your equipment --- Use a LIGHTNING ARRESTER.

The type of antenna that is used will greatly affect the performance of the transceiver. Use a properly adjusted antenna, of good quality, to enable your transceiver to perform at its best. The antenna input impedance is 50 ohms. Use 50-ohm coaxial cable such as RG-8 or 5D-2V for this connection. If the antenna is far from the transceiver the use of low loss coaxial cable, such as 10D-2V is recommended. Match the impedance of the coaxial cable and that of the antenna so that the SWR is less than 1.5 to 1. The protection circuit in the transceiver will activate if the SWR is particularly poor (greater than 2 to 1).

(3) External speaker

The TS-950SDX includes a built-in speaker. If you would like to use an external speaker, such as the SP-950, it may be connected to the EXT SP jack on the rear of the radio. The speaker may be any good 8 ohm permanent magnet type speaker. The diameter should be at least 4 inches for good audio quality. If you plan on using a speaker other than the SP-950, it should be equipped with a miniature phone jack plug. (diameter 3.5 mm)

External Speaker and Voice Outputs

Using an external speaker, you can switch the MAIN and SUB voice outputs.

To switch the voice outputs, use the MENU key as

(2) Grounding

Caution
Never use a gas pipe or electrical conduit pipe for ground connection.

Notes
1. A ground connection that is a 1/4 wavelength or its multiple may provide a good DC ground, but it will not provide a good RF ground.
2. A city water pipe cannot be used as a good earth in some cases.

Making a good earth connection is important for preventing dangers such as electric shock and for emitting a high quality signal with minimum spurious radiation. Bury a commercially available ground rod or copper plate under the ground and connect it to the GND terminal. A thick wire, cut as short as possible, should be used for the connection. To make a good earth connection, connect the GND

1. Press the MENU key.
2. Adjust the M.CH/VFO CH control to select menu number 06. The SUB frequency display will then show the current setting.
3. Use the UP/DWN switches to select the desired function.
4. Press the MENU key again to complete this MENU operation.

Settings and speaker outputs

Selection	Internal speaker	External speaker
OFF	MAIN and SUB	MAIN and SUB
1	SUB (and "MAIN")	MAIN (and "SUB")
2	SUB	MAIN

Notes
1. The parentheses in the above table indicate the band whose output volume is smaller compared with when you select OFF. To increase the

1. COUNTERCLOCKWISE.
2. If setting 1 or 2 is selected, the internal speaker does not beep for any key operation.

(4) Key connection

Your key should be connected as illustrated in the figure below. When using an electronic keyer, make sure that it is set for positive keying. Always use shielded line from the key to transceiver. (plug diameter is 6.0 mm)

■ To use external straight key

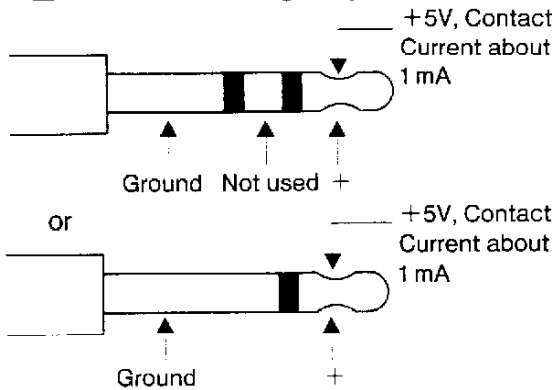

Note

Check the polarity of the plug when you use an electronic keyer.

See Section 4-3-6 for additional CW key/ keyer connection information and diagrams.

B. Front Panel

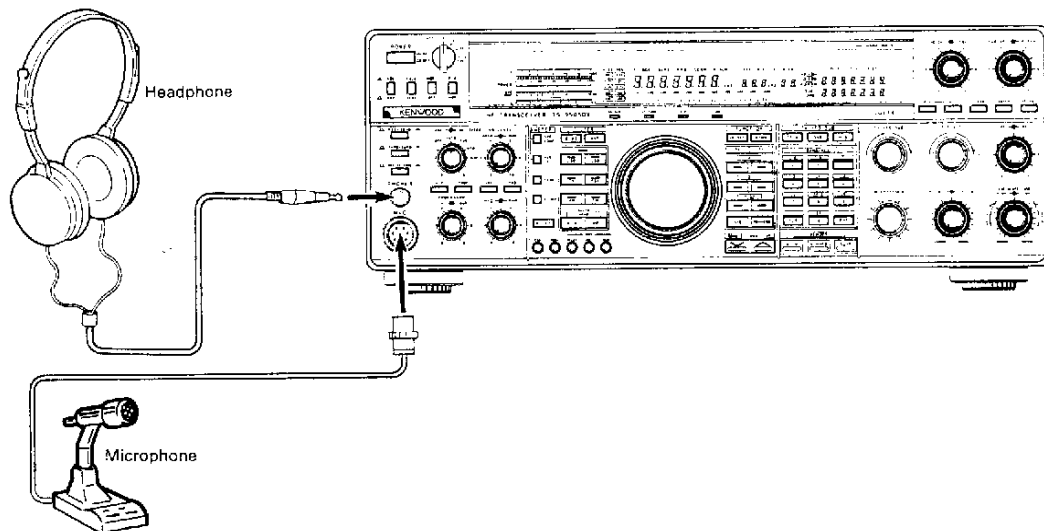

(1) Headphones

Any low-impedance (4-16 ohms) headphones may be used with the transceiver. Connect the headphones to the front panel PHONES jack. (diameter 6.0 mm). The optional HS-5 or HS-6 headphones are best suited for use with the transceiver. Stereo-type headphones can also be used. When using Stereo headphone the main band will be heard on one side and the sub-band on the other side. If the sub-band is turned off no audio will be heard on the sub-band side.

(2) Microphones

Any microphone with an impedance between 250 Ω to 600 Ω may be used with this transceiver. The KENWOOD microphones MC-43S (handheld), MC-60A, MC-80, MC-85, MC-90 (table-top type) are recommended.

Downloaded by
Amateur Radio Directory

4. OPERATION

4-1. OPERATING CONTROLS

4-1-1. Front Panel

Note

All segments on the Display Panel and Indicators are shown for this explanation.

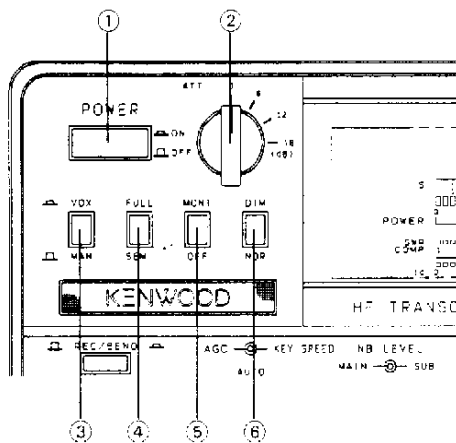
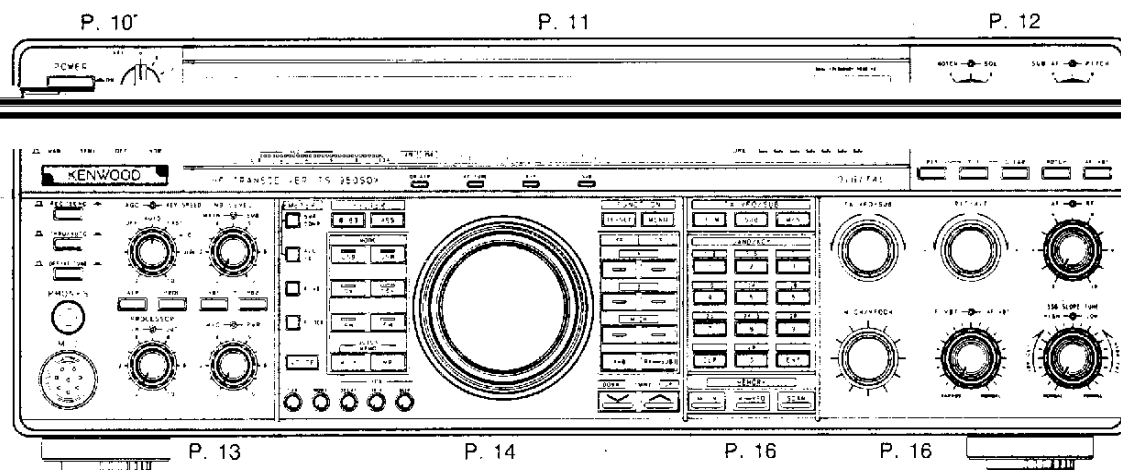

① POWER switch

Press to turn the power ON or OFF.

② ATT (Attenuator) switch

When the incoming receive signal is very strong, the signal should be attenuated to prevent distortion of the signal, thereby stabilizing the receiver performance. This is easily done by activating the ATT switch. This control is also useful when a strong signal is near your desired signal; while some loss will occur to the desired signal, as well as the undesired signal, the use of the attenuator will sometimes allow you to understand what is being received. This switch allows attenuation of the input signal by 6, 12 or 18 dB. For normal receiver performance, this switch should be in the 0 dB position.

③ VOX/MAN switch

VOX (Voice Operated Switch) operation is possible in SSB, AM or FM operations. Break-in operation is possible in CW operation. To activate the VOX circuitry place the VOX switch ON (▲).

④ FULL/SEMI (Break-in) switch

This switch affects the transmit/receive recovery time. In the SEMI position the transceiver will key when the key is depressed and remain in the transmit position until a preset delay has been reached. In the FULL position the transceiver will switch back to receive as soon as the key is released, thus allowing you to copy incoming signals between characters.

⑤ MONI (Monitor) switch

Allows monitoring of your transmit signal.

⑥ DIM (Dimmer) switch

Selects the intensity of both the digital display and the meter illumination, bright or dim.

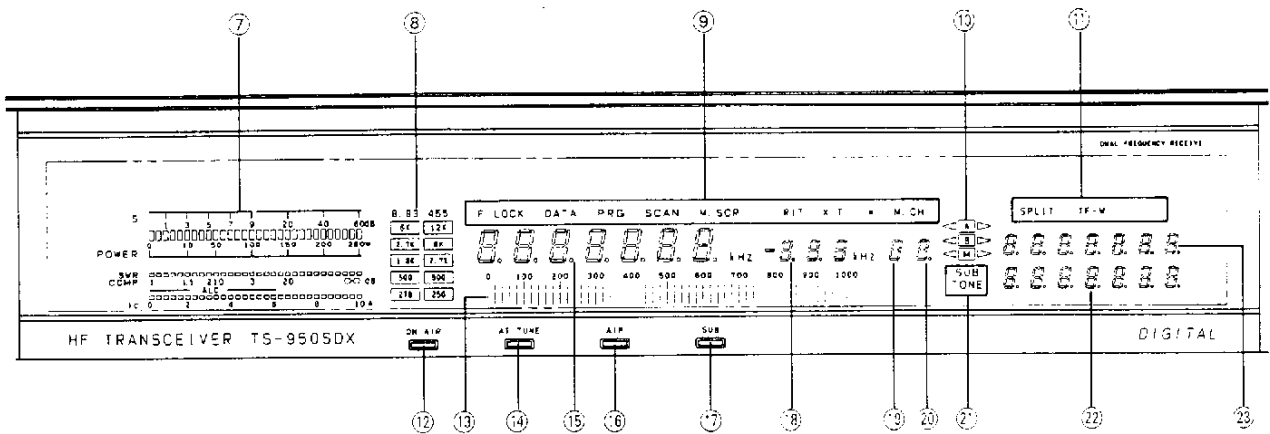

⑦ Meter

During receiving of signals the meter is used as an S-meter. During transmission the meter is used as a POWER meter, and is controlled by the METER switch, and provides either VSWR, COMP level, ALC level, or Ic meter readings.

Notes

1. Simultaneous reading of SWR and COMP level is not possible.
2. Simultaneous reading of ALC level and Ic is not possible.
3. Simultaneous reading of more than three data items is not possible.
4. The bottom scale functions as an S-meter for the Sub-band during Sub-band receive operations.

⑧ Filter indicators

Indicate which filters have been selected. Works for Main or Sub-band depending on the setting of the M/S switch ⑧.

⑨ F.LOCK display

Lights when the F.LOCK key is ON.

DATA display

Lights when the DATA MODE is ON.

PRG (Program) display

Lights during selection or operation on memory channels 90 to 99.

SCAN display

Turns ON during scanning.

*** display**

Turns ON when using FINE.

M.CH (Memory channel) display

Turns ON during a Memory Channel operation.

⑩ <A> display

Lights when VFO A is selected and shows that the VFO is operating.

** display**

Lights when VFO B is selected and shows that the VFO is operating.

<M> display

Lights when a memory channel is selected and shows that the Memory function is operating.

⑪ SPLIT display

Turns ON during split operation.

TF-W (TX Frequency Watch) display

Turns ON during TF-W operation.

⑫ ON AIR indicator

Lights during transmission.

⑬ Analog Scale

Shows the frequency selected. Full scale can be switched to either 1 MHz or 100 kHz depending on the function setting when the power switch is turned on. (See section 4-2-13.)

⑭ AT TUNE (Antenna Tuner) indicator

Turns ON and indicates the memory channel without a loss of the incoming receive frequency.

RIT display

Turns ON when using RIT.

XIT display

Turns ON when using XIT.

⑮ Frequency display

Indicates the operating frequency.

⑯ AIP(Advanced Intercept Point) indicator

Lights when the AIP switch is ON.

⑰ SUB indicator

Lights when the SUB receiver is turned on by the SUB key, then the M/S key is pressed.

⑮ RIT/XIT frequency display

Shows the amount of RIT/XIT offset to the nearest 10 Hz. Minus "-" appears in the display when the RIT / XIT offset is below the transmit / receive frequency.

⑯ Memory Channel number display

Memory Channel Number is displayed.

⑰ Memory Channel Lockout Indicator

The ● display indicates the Memory Channel currently in the display will be skipped during Memory Channel scan.

⑱ SUB display

Lights when the SUB key is ON.

TONE display

Lights when the TONE is ON.

⑳ SUB Frequency display

Indicates the sub operating frequency or tone frequency.

㉑ TX frequency display

Indicates the TX operating frequency or memory channel frequency.

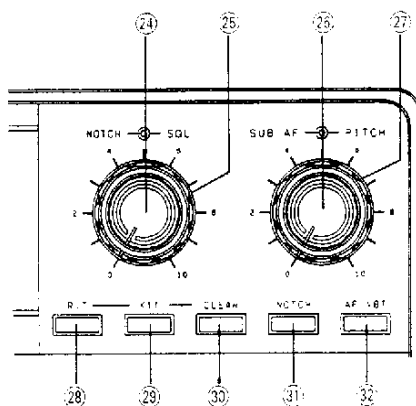

㉒ NOTCH control

The NOTCH function is used to reduce or eliminate heterodyne, or CW type signals. The NOTCH filter will not be effective against SSB, AM, or FM type signals.

㉓ SQL (Squelch) control

This control is used to eliminate atmospheric noise, and receiver static noise during no signal periods. Slowly rotate the control clockwise to the point where the ambient noise just disappears, and the speaker shuts off. This point is known as the squelch threshold point. Now you will only hear output from the speaker when an incoming signal is present. For weak signal reception this control should be fully counterclockwise.

㉔ SUB AF gain control

Turn the knob to increase or decrease the SUB receiver volume. Clockwise rotation increases the volume and counterclockwise rotation decreases the volume.

㉕ PITCH control

The CW PITCH control is provided so that you may adjust the frequency of the incoming CW signal so that the tone is pleasing to you. The TS-950SDX accomplishes this without shifting the actual transmit or receive frequency, by shifting the 100kHz IF frequency, just prior to product detection.

㉖ RIT switch

Press to turn the RIT ON or OFF.

㉗ XIT switch

Press to turn the XIT ON or OFF.

㉘ CLEAR switch

Pressing the CLEAR switch restores the RIT/XIT to zero.

㉙ NOTCH switch

When this switch is ON, the notch filter is activated.

㉚ AF VBT switch

The AF VBT circuit is just the opposite of the NOTCH circuit. With this control it is possible to accentuate the desired signal by providing additional rejection of noise and interfering signals whose pitch (tone) falls outside the audio passband.

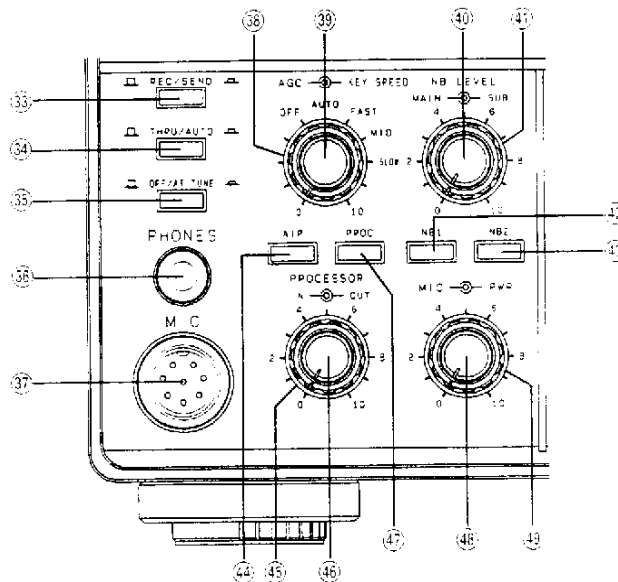

33 REC/SEND switch

This switch is used when you want to manually control transmission or receiving.
REC : Places the radio into the receive mode.
SEND : Places the radio into the transmit mode.

When the AGC switch is set to SLOW, the receiver gain and S-meter readings will react slowly to large input changes, and when set to FAST, the receiver gain and S-meter will react quickly to changes in the input signal level.

34 THRU/AUTO switch

THRU : The auto antenna tuner is not used in the transmit mode.
AUTO : The auto antenna tuner is used in the transmit mode.

When using all modes in the same position, the following, you might wish to use the FAST position.

- When tuning rapidly, use the FAST position.
- When receiving weak signals.
- When a high-speed CW signal is being received.

35 OFF/AT TUNE switch

When this switch is turned ON with the THRU/AUTO switch placed in the AUTO position, the automatic tuner will be engaged and the tuner will try to match the antenna.

Note
 This switch is disabled during FM operations.

36 PHONES jack

Output terminal for headphones.

40 MAIN NB LEVEL control

Controls the noise blanker operating level. Use only the minimum level necessary.

37 MIC jack

Microphone connection.

41 SUB NB LEVEL control

Controls the noise blanker operating level. Use only the minimum level necessary.

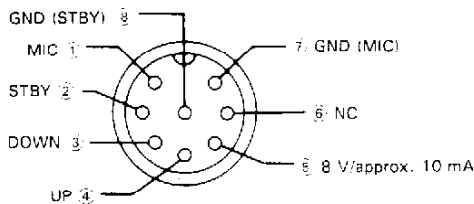

MIC connector (Front view)

42 NB 1 switch

For pulse type noise, such as generated by automotive ignition systems, turn the NB 1 switch ON. This switch will not help to eliminate atmospheric or line noises, only pulse type noise.

38 KEY SPEED control

This controls the speed of the electronic keyer. Turn the knob clockwise to increase speed.

43 NB 2 switch

Noise blanker 2 is used for long duration pulse noise, like the "woodpecker". To reduce "woodpecker" radar noise interference, set switch NB 2 to the ON position (NB 2's effectiveness depends on the specific type of interference). If you use NB 2 for short duration pulse noise, the receive tone may become distorted, making it difficult to hear. Unfortunately no noise blanker can remove all different types of interference, but the two noise blankers that have been provided in the TS-950SDX are effective in most cases. If there is no "woodpecker" present, the switch should be in the OFF position.

39 AGC switch

This switch selects the operating time constant of the AGC (Automatic Gain Control) circuit. When the AGC switch is set to AUTO the gain is automatically controlled for the selected mode.

44 AIP (Advanced Intercept Point) switch

Use AIP when good signal reception in a crowded band cannot be obtained. When switched on, it reduces interference from strong signals.

Note
When AIP is on, the sensitivity of the receiver is reduced about 10 dB.

45 PROCESSOR-OUT control

Set the METER switch to ALC and adjust the PROCESSOR-OUT control while speaking into the microphone. Ensure that the meter deflection is within the ALC zone!

46 PROCESSOR-IN control

Adjust the PROCESSOR-IN control while speaking into the microphone in a normal tone of voice, for a peak COMP scale reading of no more than 10 dB. Do not overdrive the compressor.

Over driving the compressor will deteriorate voice quality, increase transmitter noise level, and in general make copying your signal more difficult.

47 PROC (Processor) switch

Effective transmit power output will increase when the PROC switch is turned ON during SSB mode operations.

48 MIC gain control

Microphone gain can be adjusted during SSB and AM operations. Gain is increased by turning the control clockwise.

49 PWR (Power) control

Power can be controlled in all modes. Power is increased by turning the control clockwise. Keep the transmit power within the output power limit of your license.

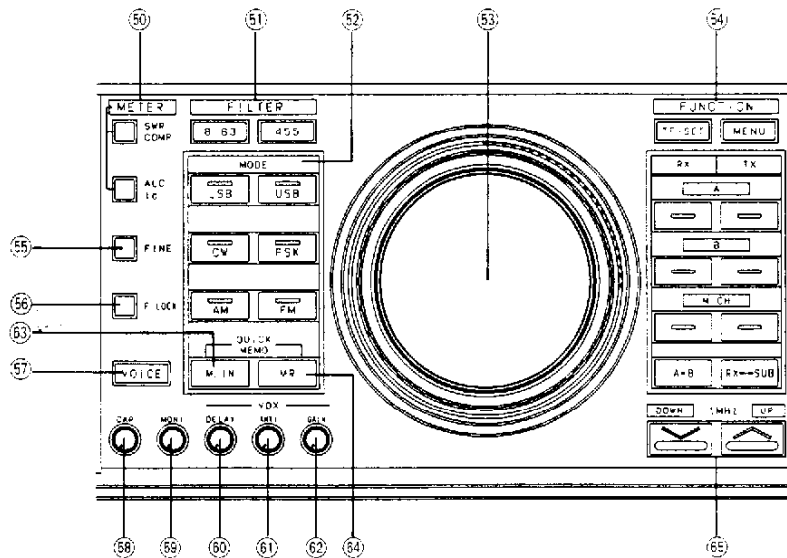

50 METER switch

These switches are used to switch meter indications during transmission.

SWR/COMP: Indicates the SWR value or compression level. When this switch is released the SWR value is indicated. When this switch is pressed the

When this switch is pressed, the drain current (Id) of the final FET is indicated. Since the Id meter is calibrated at the values normally encountered, its indication may not be accurate at very low currents such as the idling current.

When this switch is released the ALC operating state is indicated.

regardless of mode.
455 : Selects the desired 455kHz filter regardless of mode.

⑤② MODE keys

These keys are used to select the desired operating mode. When a MODE key is pressed, the first character of the selected mode will be sounded in Morse code through the internal speaker.

DATA mode: In the SSB/AM/FM mode, pressing the same key twice (once if the key was pressed previously) will select the DATA mode. The DATA indicator lights. Pressing the same key once again will cancel the DATA mode. When the FSK mode is selected, it is automatically switched to the DATA mode.

The DATA mode is used for packet communications and RTTY. When this mode is selected, signals from

the microphones are blocked and modulation is provided by the incoming DATA from the ACC2 connector on the rear panel during transmission. In the FM mode, the time constant for squelch becomes fast.

Notes

1. When the DATA mode is selected, no modulation will be provided from the microphone.
2. The DATA mode is canceled when another mode is selected.

TX : Press this key to transmit signals on VFO B.

M.CH (Memory) key

RX : Press this key to receive signals on the memory channel.

TX : Press this key to transmit signals on the memory channel.

A=B key

Equalizes the frequencies and modes of VFO A and VFO B.

RX→SUB key

Press this key to transfer the receive frequency to SUB.

Note

The receive frequency cannot be transferred when SUB is off.

⑤⑤ FINE switch

One turn of the tuning knob is made equivalent to 1kHz (1Hz step) in the SSB, CW, and FSK modes to facilitate tuning. When this switch is set to ON, the asterisk (*) lights on the display.

⑤⑥ F.LOCK key

The selected dial frequency and mode are locked.

Note

When the F.LOCK key is on, the MENU TF-SET keys, and RIT, XIT, CLEAR, METER, FILTER, AIP,

fast tuning is possible by rotating the knob rapidly. The dial drag is adjustable by holding the outside knob and turning the inside knob clockwise to increase drag, and counterclockwise to decrease drag.

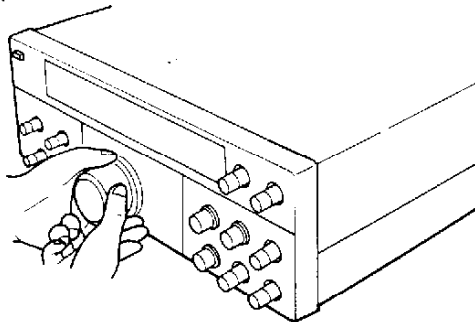

⑤④ FUNCTION keys

TF-SET key

Holding down this key will allow you to quickly set or check the transmit frequency, during SPLIT operations, without the need of actually transmitting.

MENU key

This key is used to select or cancel the menu function. Select a menu number with the M.CH/VFO CH control and change the menu contents with the UP/DOWN switches.

A (VFO A) key

RX : Press this key to receive signals on VFO A.

TX : Press this key to transmit signals on VFO A.

B (VFO B) key

RX : Press this key to receive signals on VFO B.

⑤⑦ VOICE switch

Press this switch to activate the optional voice synthesizer unit VS-2.

⑤⑧ CAR LEVEL (Carrier level) control

Used to adjust carrier level during CW and AM.

⑤⑨ MONI (Monitor) control

This controls the volume of the transmit monitor.

⑥⑩ DELAY control

This control adjusts how long the radio will remain keyed after voice input has stopped.

⑥⑪ ANTI control

VOX operations are sometimes difficult with high speaker volume control settings. The ANTI control is used to reduce the tendency of the VOX to activate from inputs from the speaker. The ANTI control is not active when headphones are connected.

⑥⑫ GAIN control

This control adjusts the sensitivity of the VOX amplifier. Adjust this control for your personal preference.

⑥⑬ QUICK MEMO M.IN key

This key writes data to the quick memory.

⑥⑭ QUICK MEMO MR key

This key recalls the quick memory.

65 1MHz UP/DOWN switch

Pressing the UP switch increases the frequency, and pressing the DOWN switch decreases it.

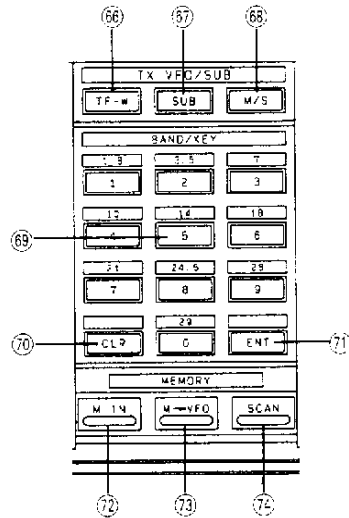

66 TF-W (TX Frequency Watch) key

Use this key to activate/deactivate the TF-Watch function.

67 SUB Receiver key

Use this key to turn the Sub Receiver ON or OFF.

Note

The Sub-receiver is operational in the SSB, CW and FSK modes only.

68 M/S key

Use this key to specify which band (Main or Sub) is controlled by the tuning controls, and filter, mode, band keys, etc. When the Sub receiver is selected the Sub indicator will light.

69 BAND/KEY key

Used to select or enter a radio frequency band.

keypad is used to enter data into a memory channel. When the M/S key is used to control the Sub-receive this key is used to control the Sub-receiver band.

70 CLR (Clear) key

Used when reentering memory channel data, erasing a memory channel, quitting scan, or when specifying the channels that will be skipped during scan operations.

71 ENT (Enter) key

Used to directly enter a frequency from the numeric keypad. This is also used to select either the Main or sub-receiver depending upon M / S key selection.

72 M.IN key

Used to enter data into a memory channel.

73 M→VFO key

Used to transfer a frequency from memory to the VFO.

74 SCAN key

Use to initiate program scan during VFO operation and use to initiate memory scan during memory operation.

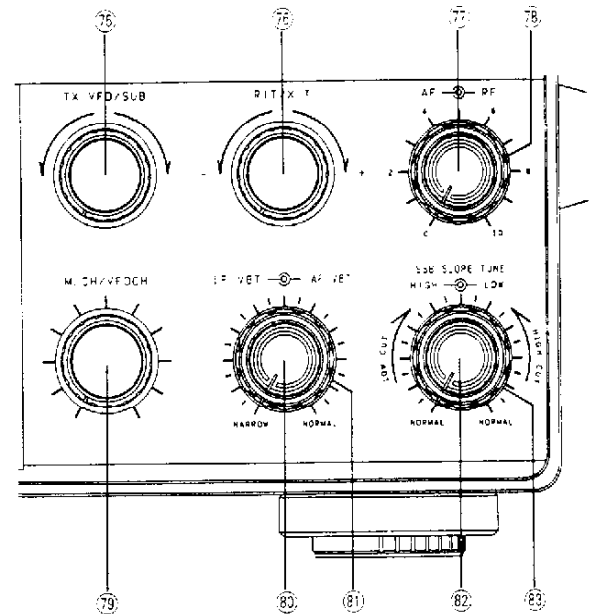

75 TX VFO/SUB control

When the Sub receiver is OFF, the transmit frequency indicated in the TX frequency display can be changed with this control.

Note

This control does not function during simplex operations.

76 RIT/XIT control

RIT (Receiver Incremental Tuning)

First, cancel any previously programmed offset using the CLEAR switch, then turn the RIT switch ON. The RIT control shifts the receiver frequency up to ± 9.99 kHz. Use of the RIT control will not affect the transmit frequency. When the RIT switch is ON, the RIT indicator will light, and the receive frequency can be adjusted using the RIT control. Pressing the CLEAR switch restores the RIT to zero.

Note

When the RIT is ON the transmit frequency may be different from the receive frequency. For normal operation, leave the RIT switch OFF. It should be used only when necessary.

XIT (Transmitter Incremental Tuning)

XIT is very similar to RIT. XIT is only active in the transmit mode. By using the XIT function it is possible to offset the transmit frequency without the normal loss of receiver audio that is experienced when using the SPLIT function.

Offsets of ± 9.99 kHz are possible.

The RIT / XIT offset can be preset, without affecting the actual operating frequency by turning OFF the RIT/XIT and using the RIT/ XIT display to determine the offset.

This is useful to communicate with a DX station using "split" within the XIT range.

⑦ AF gain control

Turn the knob to increase or decrease the volume. Clockwise rotation increases the volume and counterclockwise rotation decreases the volume.

Note

The output level of the "Beep" and "Sidetone" are not affected by the setting of the AF gain control.

⑧ RF gain control

This control adjusts the gain of the receiver high-frequency amplifier section.

For normal receiver performance and maximum gain, this control should be turned clockwise to the limit. If you are having trouble copying the desired signal make a note of the stations peak S-meter reading. Then adjust the RF gain control left so that the meter needle is stationary at this level. Now all signals that were less than the desired signal will be attenuated, such as static noise, etc., making reception easier.

If the incoming signal pegs the S-meter you can also reduce the receiver gain by moving the RF gain control to the left. The S-meter lamps will light sequentially as the RF gain control is turned, to indicate that the gain has been reduced.

Simultaneous use of the RF gain control and AGC switch

If a strong signal (such as a local station) appears in the vicinity of the intended receive signal, the S-meter may show unusual deflection due to the AGC voltage developed from the strong disturbing signal. If this occurs, move the RF gain control to the left so the meter pointer remains at about the original deflection peak and turn the AGC switch to the FAST position. This will reduce the unwanted AGC voltage and permit clear reception.

⑦⑨ M.CH/VFO CH control

This control is used to change the frequency in 10 kHz steps during VFO operations.

This control is also used to select the desired memory channel during Memory Channel Operation.

⑧⑩ IF VBT control

This control is very similar to the SSB Slope Tuning controls. However, with the IF VBT control one

side of the IF passband can be narrowed. The actual range depends upon the CW filters that have been installed.

⑧① AF VBT control

Turn the knob to ease interference when in the CW receive mode.

⑧② SSB SLOPE TUNE HIGH CUT control

Adjust the HIGH CUT control counterclockwise, and interference from signals higher than the operating frequency will be reduced. The high-frequency components of the resulting receiver audio will also be reduced.

⑧③ SSB SLOPE TUNE LOW CUT control

Adjust the LOW CUT control clockwise, and interference from signals lower than the operating frequency will be reduced. Like the HIGH CUT control, use of the LOW CUT control will also affect the audio frequency passband. In this case the low frequency components of the audio signal will be reduced.

■ Microphone

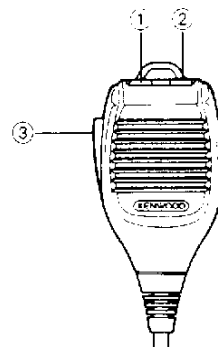

①② UP/DWN(Up/Down) switches

These switches are used to step the VFO frequency or memory channel up and down. The frequency will change continuously if the switches are pressed and held.

③ PTT (Push To Talk) switch

The transceiver will be placed into the transmit mode whenever this switch is pressed.

Downloaded by
Amateur Radio Directory

4-1-2 Quick Key Board RM-1 (Accessory)

Some of the keys on the front panel can be controlled from the Quick Key Board connected to the Key Board jack on the rear panel.

Functions that may be controlled include; REC-1, REC-2, REC-3, PLAY-1, PLAY-2, PLAY-3, CLR, TF-SET, QUICK MEMO (M.IN, MR), and VOICE (optional voice synthesizer VS-2 is required).

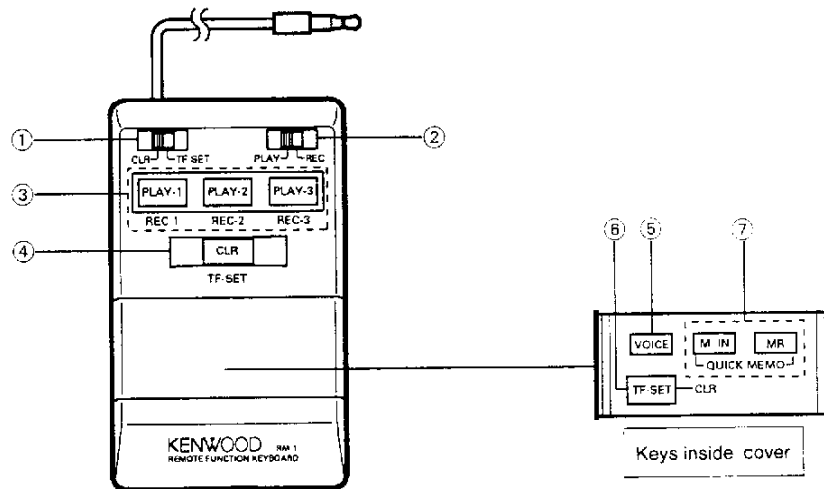

① CLR/TF-SET switch

When this switch is set to the CLR position, the CLR function is selected. When it is set to the TF-SET position, the TF-SET function is selected.

② REC/PLAY switch

When this switch is set to the REC position, the REC-1, REC-2, REC-3 functions are selected. When it is set to the PLAY position, the PLAY-1, PLAY-2, and PLAY-3 functions are selected.

③ PLAY-1/REC-1, PLAY-2/REC-2, PLAY-3/REC-3 keys

These keys are used to record CW or SSB messages. Use the REC/PLAY switch to select the REC or PLAY mode.

④ CLR/TF-SET key

The CLR function indicated on the key top or the TF-SET function indicated under the key top is selected depending on the position of the CLR/TF-SET switch.

Pressing the CLR key in the REC or PLAY mode will stop recording or playback.

⑤ VOICE key

The function of this key is the same as that of the VOICE switch on the transceiver. The displayed frequency can be announced by connecting the voice synthesizer (VS-2).

⑥ TF-SET key

The function of this key is the same as that of the TF-SET key on the transceiver. When the CLR/TF-SET switch is set to the CLR position, the TF-SET function is ineffective. When it is set to the TF-SET position, the CLR function is ineffective.

⑦ QUICK MEMO key

The function of this key is the same as that of the QUICK MEMO key on the transceiver.

M.IN key

The current operating status can be stored in one of the five memory channels one after another.

MR key

This key is used to recall the stored data from the memory. Use the M.CH/VFO CH control to recall a memory channel.

Note

See the explanation of the CW message function in 4-6 and DRS (Digital Recording System) functions in 4-7.

4-1-3. Rear Panel

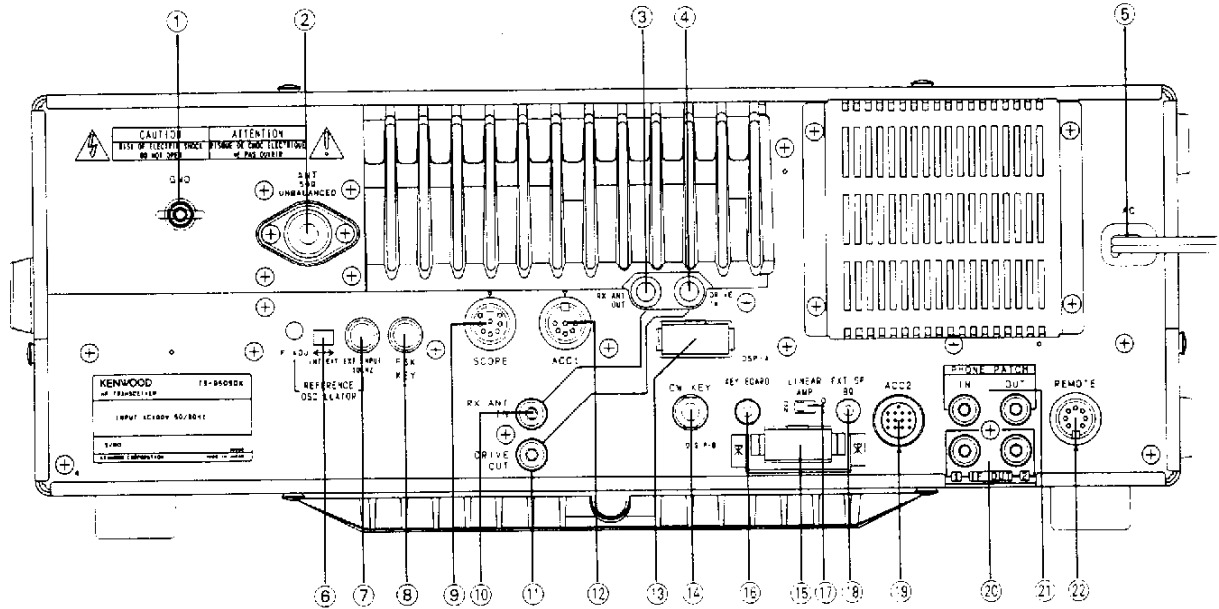

① GND (Ground) terminal

To prevent electric shock, as well as RFI and BCI, connect the transceiver to a good earth ground.

② ANT (Antenna) connector

This connector should be attached to a suitable antenna for transmitting and receiving. The antenna cable should be a 50-ohm coaxial cable, terminated with a PL-259 connector.

③ RX ANT OUT terminal

This is the antenna terminal for reception. Signals received at the ANT connector are sent to this terminal. This terminal is normally linked to the RX

⑨ SCOPE connector

Use this connector to plug in the Station Monitor SM-230 (option).

⑩ RX ANT IN terminal

This is the antenna input terminal during receiving. It is normally linked to the RX ANT OUT terminal ③ with a jumper. An antenna for receiving only can be connected to this terminal.

⑪ DRIVE OUT terminal

This is the drive output terminal for transmitting signals. It is normally connected to the DRIVE IN terminal ④ with a jumper. The TX Drive level at this

an external receiver, it would be connected to this point.

④ DRIVE IN terminal

This is the final stage input terminal. It is normally linked to the DRIVE OUT terminal ⑪ with a jumper.

⑤ AC power cable

Connect this cable to an electric outlet.

⑥ REFERENCE OSCILLATOR switch

Switch to OSCILLATOR using tweezers to receive an external frequency standard signal.

⑦ EXT INPUT terminal

This is the input terminal for an external standard signal.

⑧ FSK KEY terminal

For connection to an RTTY interface unit. (direct FSK keying).

⑫ ACC 1 jack

The optional IF-232C is connected here.

⑬ DSP-A connector

The DSP unit is connected here.

⑭ CW KEY jack

Using shielded line, connect a 6.0 mm diameter phone plug to this jack for CW operation. Connect a paddle type key to the key jack. Use a 6.0 mm diameter stereo plug. Open-terminal voltage is approximately 5 VDC. (See Section 4-3-6 for additional key information.)

⑮ DSP-B connector

The DSP unit is connected here.

⑩ **QUICK KEY BOARD jack**

This jack is used to connect the RM-1.

⑪ **LINEAR AMP switch**

Activates the relay for the linear amplifier control.

⑫ **EXT SP (External speaker) jack**

This jack is for connection of an external speaker.

⑬ **ACC 2 connector**

Terminal numbers and their applications are as follows:

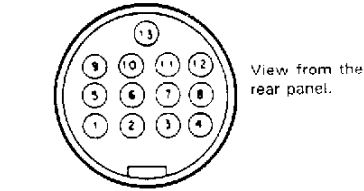

13-pin DIN plug (E07-1351 05)

ACC2 pin assignments

Pin number	Symbol	Use
1	SANO	Sub receiver audio at a fixed level independent of Sub AF gain control setting. Output more at high input level
2	NC	No connection
3	MANO	Main receiver audio at a fixed level independent of AF gain control setting. Output voltage: 300 mV/4.7 kΩ or more at high input level
4	GND	Grounding (The shielded wire of the audio output terminal is connected here.)
5	PSQ	This pin is used for connecting a TNC (Terminal Node Controller) for use with packet radio. It is the Squelch Control terminal and will not allow packet communications while squelch is off.
6	Output voltage pin for S-meter.	Output voltage varies with S-meter indication.

ACC2 pin assignments

Pin number	Symbol	Use
7	NC	No connection
8	GND	Grounding
9	PKS	This is the standby pin used exclusively for the terminal unit. When this pin is used for standby, the microphone input is automatically shut off during transmission.
10	NC	No connection.
11	PKD	This is the MIC (microphone) input pin from the terminal unit. The input level is approximately 20 mV.
12	GND	Grounding (The shielded wire of the audio output terminal is connected here.)
13	SS	Standby terminal. Grounding places into the transmit mode.

⑭ **IF OUT jack**

This jack is for the band scope of the station monitor.

IF 1 is for connection to the SM-230 for Pan Display (8.83 MHz)

Modulation Display. (100 KHZ)

⑮ **PHONE PATCH jacks**

The IN terminal is used for transmit audio from the phone patch (600 Ω).

The OUT terminal is used for received audio from the transceiver to the phone patch (600 Ω). These jacks can also be used for input to and from SSTV, or RTTY terminals.

⑯ **REMOTE connector**

This jack is for connection with a linear amplifier.

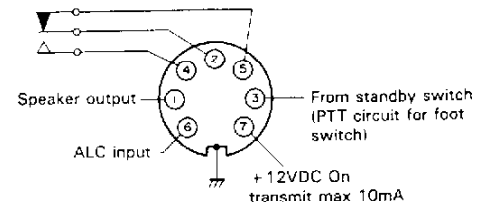

View from cord

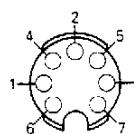

Internal wiring

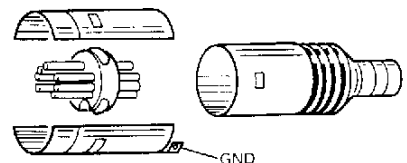

4-2. RECEIVER OPERATION

Different Main and Sub Receiver frequencies can be received simultaneously. Reduce the audio of the band you do not want to hear. You can turn off Sub Receiver audio, if you do not need it, with the SUB key.

4-2-1. Receiving

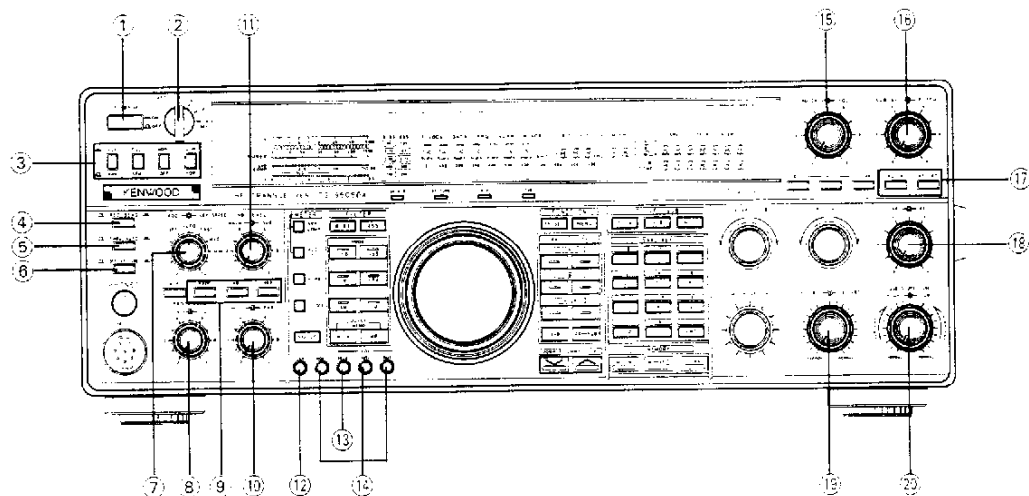

1. Connect the AC power cord and the antenna, and then set the switches and controls as follows:

- ① POWER switch : OFF (■)
- ② ATT switch : 0 dB
- ③ VOX/MAN, FULL/SEMI, MONI, DIM switches : OUT (■)
- ④ REC/SEND switch : REC (■)
- ⑤ THRU/AUTO switch : THRU (■)
- ⑥ OFF/AT TUNE switch: OFF (■)
- ⑦ AGC switch : FAST
KEY SPEED control : Center
- ⑧ PROCESSOR IN, OUT: Center
- ⑨ PROC, NB1, NB2 switches : OFF (■)
- ⑩ MIC, PWR controls : Fully counterclockwise
- ⑪ NB LEVEL controls : Fully counterclockwise
- ⑫ CAR control : Fully counterclockwise
- ⑬ DELAY control : Center
- ⑭ MONI, ANTI, GAIN controls : Fully counterclockwise
- ⑮ SQL control : Fully counterclockwise
- ⑯ SUB AF gain control : Fully counterclockwise
PITCH control : Center
- ⑰ NOTCH, AF VBT switches : OFF (■)
- ⑱ AF gain control : Fully counterclockwise
RF gain control : Fully clockwise
- ⑲ IF VBT control : Fully clockwise
AF VBT control : Fully clockwise

⑳ SSB SLOPE TUNE

HIGH CUT control : Fully clockwise

LOW CUT control : Fully counterclockwise

2. After presetting the controls as described above, turn the transceiver's POWER switch ON. The display panel will indicate as shown below.

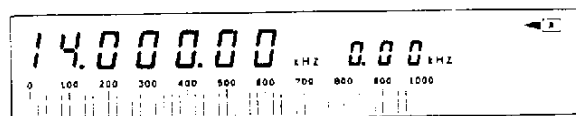

Note

If the display is not as shown, reset the microprocessor using the procedure provided in Section 4-4-2.

3. Turn the AF gain control clockwise until a signal or noise is heard.
4. Rotate the TUNING knob and select a frequency not currently used. If desired, adjust squelch as follows: turn the SQL control clockwise until the noise just disappears.
5. Select the desired operating frequency. When a signal is received, the S-meter will deflect.
6. To turn off the transceiver, press the POWER switch again.

4-2-2. Beep Tones

Audible confirmation of various microprocessor functions is provided in the form of a series of audio beeps. The output level of the "Beeper" is adjustable with a variable resistor located inside the transceiver. (Please refer to Section 5-6-4.)

4-2-3. Audible Mode Announcement

When a Mode key is pressed, the first character of the mode is sounded in Morse code through the speaker. (Note that FSK is announced with an "R")

Mode	Morse code
LSB	• — • •
USB	• • —
CW	— • — •
FSK	• — •
AM	• —
FM	• • — •

Note

You can select a single audio beep rather than Morse Code confirmation. (See 4-2-13 Menu No. 51.)

4-2-4. Additional Key Announcements

The TS-950SDX is capable of announcing the status of several front panel switches in morse code. To activate this function, turn the power ON while holding down the VOICE key. Repeat this procedure to turn the function OFF.

Example: When the band is switched, the following Morse codes are output through the speaker:

Band	Meaning of Morse code
1.8	1R8
3.5	3R5
7	7
10	10
14	14
18	18
21	21
24.5	24
28	28
29	29

4-2-5. SSB AUTO Mode Shift

This transceiver automatically selects the appropriate sideband when in the SSB mode.

10 kHz	9.5 MHz	30 MHz
LSB	USB	

Notes

1. USB is selected for 9.5 MHz and above.
2. The AUTO mode selection will not function when using RIT.

4-2-6. Frequency Step

TUNING knob

The frequency step depends on the mode that has been selected.

Mode	Frequency Step	One revolution of TUNING knob
SSB/CW/FSK	10 Hz	10 kHz
AM/FM	100 Hz	50 kHz

When the FINE key is ON, the frequency step is 1 Hz. The frequency step in the AM and FM modes is 10 Hz.

TX VFO/SUB control

The TX frequency step depends on the mode that has been selected.

Mode	Frequency Step	One revolution of TX VFO/SUB control
SSB/CW/FSK	10 Hz	4 kHz
AM/FM	100 Hz	40 kHz

When the FINE key is ON, the frequency step is 1 Hz. The frequency step in the AM and FM modes is 10 kHz.

M.CH/VFO CH control

The active VFO frequency step is as shown below.

Frequency Step	One revolution of M.CH/VFO CH control
10 kHz	250 kHz

The frequency step may be reprogrammed when turning on the POWER switch. (See 4-2-13 Menu No. 63.)

This control is also used to select the desired memory channel during Memory Channel Operation.

4-2-7. Amateur Radio Bands Selection

Press the BAND/KEY key to change amateur radio bands. If the Sub Receiver function is active, it will also be changed.

4-2-8. Dual Digital VFO's

Operational convenience is enhanced through the use of two VFO's.

Two VFO's are provided to allow you to change frequencies quickly with the least amount of dial rotation. For example, you could set one VFO to the lower tuning limit and the other VFO to the upper tuning limit.

A=B key

Pressing this key resets the data of the inactive

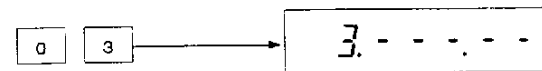

- After the least significant digit has been entered press the ENT key again to signify you want the transceiver to change frequency. If you entered the frequency down to the nearest 10 Hz a beep

Note

When a memory channel is being used for reception, the A=B key will not function.

For example:

RX VFO A is set at 7 MHz in LSB, and RX VFO B is 14 MHz in USB. RX VFO A is the active VFO (shown in the display). Pressing the A=B key will cause RX VFO B to change to 7 MHz in LSB.

For example:

To enter 14.200 MHz, there are two methods:

Method 1: Press [ENT] [1] [4] [2] [ENT]

Method 2: [1] [4] [2] [ENT]

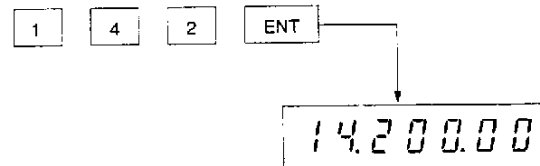

4-2-9. Direct Keyboard Frequency Entry

Direct keyboard entry of the operating frequency is possible using the numeric keypad on the transceiver. This allows quick changes in frequency without the delays encountered when using other tuning methods.

Note

You cannot enter any frequency which is outside the coverage of the transceiver.

- Press the ENT key. The following display will appear.

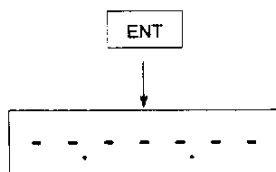

- Enter the desired operating frequency down to the arbitrary digit. You do not have to enter trailing zeros, but you must enter leading zeros.

- If you make a mistake while entering the frequency and have not yet pressed the ENT key, or entered the final digit, you may cancel the input by pressing the CLR key.

4-2-10. CW Zero-beat Operation

In CW operation equalizing the incoming receive frequency with that of your transmit signal is called "Zero beating". The TS-950SDX enables you to zero beat in the following manner:

- Turn the MONI switch to OFF.
- The VOX/MAN switch has been set to MAN, and depress the straight type key.
- A side tone will be heard from the speaker.
- Adjust the TUNING knob so that the transmit frequency of the station you are receiving is equal to the side tone frequency. Zero beating is now completed.

4-2-11. Simultaneous Reception of Two Frequencies and TF-W Operation

The TF-W function allows you to transfer the Sub

the same time and the TF-W function are provided to make split frequency operation as convenient as possible.

After tuning in the DX station press the SUB key to

for those stations who are currently talking to the DX station at the same time as you are monitoring the DX station. This will make it easy for you to find out how far he is operating up or down in frequency. Once you have discovered his pattern, you should select split transmit operation and then press the TF-W key.

Notes

1. When the TX VFO is operating in the MEMORY mode, or if both the RX and TX VFO are in the MEMORY mode, this feature will not function.

receiver may become worse when its frequency much differ from the frequency of the Main band.

3. Some combinations of transmit and receive frequencies might result in an internal heterodyne signal (birdie). This is not a defect and is caused by certain frequency relationships.
4. The time constant of the AGC of the Sub band

14.000 MHz, the transmit frequency in VFO B is 14.200 MHz, and the Sub frequency is 14.100 MHz. Then, pressing the TF-W key will cause the VFO B frequency (the one we want to transmit on) to become 14.100 (the same as the Sub frequency).

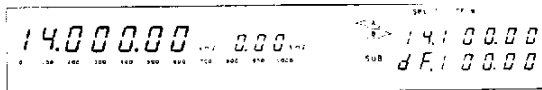
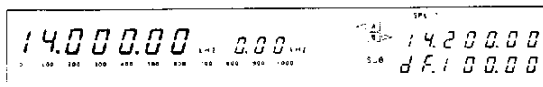

- 2) The receive frequency in VFO A is 14.000 MHz, the transmit frequency in VFO B is 14.200 MHz, and the Sub receiver is off (i.e. Single frequency operation). Also, when the TF-W key is pressed

monitoring the transmit frequency of 14.200 MHz as confirmed by the Sub frequency display.

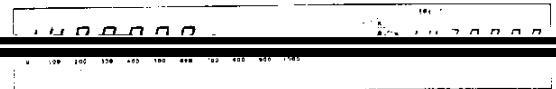

1. Tune the receive frequency on the main band to the DX station.
2. Press the SUB key. Your transceiver starts reception using the Sub band.
3. While holding down the CLR key, press the RX-SUB key. The frequency of the Main band is copied to the Sub band.

5. Press the B key located under TX. Your transceiver enters the split operation mode, and the SPLIT indicator appears.

6. Press the TF-W key. The frequency of the Sub band is set to the transmission VFO. In addition, the TF-W indicator appears, and the offset relative to the Main band frequency appears with the dF indicator in the Sub band receive frequency display area. You can also change the setting so that the dF indicator will not appear. (See 4-2-13

7. Then you can change the receive and transmit frequencies of the Sub band simultaneously using the TX VFO/SUB control.

Pressing the M/S key allows you to change the frequency of the Sub band using the TUNING knob, and then permits easier operation.

4-2-12. Menu Function Selection

Many of the functions of this transceiver can be reprogrammed to match your particular operating requirements.

1. Press the MENU key.
2. A menu number will appear in the display.
3. Select the desired menu number by rotating the M.CH/ VFO CH control.
4. Change the function by pressing the UP/DOWN keys on the front panel.
5. To return to the normal frequency display press the MENU key again.

Menu No.	Function Description	Initial State
00	"P Hold" Meter peak holding ON/OFF	OFF
01	"Pitch" Displays the current CW pitch frequency. Use the pitch control to change the frequency.	—
02	"Bright" Select the desired display brightness when the DIM switch is turn ON. Select the desired level between 30(dimmiest) to 70 (brightest).	50
03	"Delta f" Turns the delta-F (dF) function ON and OFF in the sub-receiver frequency display section.	ON
04	"Convert" Transverter frequency display control for 50MHz, 144MHz or 430MHz.	OFF
05	"Cross" Allows operation of the Main and Sub receiver. ON/OFF	OFF
06	"Stereo" Select the desired speaker output configuration. OFF: MAIN + SUB Audio from the Main and Sub receivers is supplied simultaneously to the external speaker jack and internal speaker. 1: SEMI-SEPARATION The internal speaker has audio from both bands, but the audio from the Main receiver is at a reduced volume and is not adjustable. The external speaker also has audio from both bands, but in this case the Sub receiver audio is at a constant low level.	OFF

	The internal speaker provides Sub receiver audio and the external speaker provides Main receiver audio.	
07	"Spot" 500kHz marker control ON/OFF When this function is ON, a marker signal is heard every 500 kHz.	OFF
08	"At Auto" Auto Tuner control ON/OFF Setting this to ON allows the Auto Tuner to function, and setting to OFF places the tuner into the manual control mode.	ON
09	"Transfr" Data Transfer function control. This allows transfer of data between two TS-950SDX transceivers.	OFF
10	"Direct" Determines whether signals are to be directly written to the VFO when using the data transfer function.	OFF

CAUTION

Menu number 11 will only enable an IF and AF mute function. It will not protect the front end of the transceiver. Make sure you connect the ANT terminal to ground when transmitting on the other transceiver.

Menu No.	Function Description	Initial State
11	"T inh" Determines if the master transceiver has transmit inhibited (ON) or not (OFF).	OFF
12	"Paddle" Electronic keyer ON / OFF control	OFF
13	"Auto" Controls the Auto Weight function of the electronic keyer. (Menu 12 must be on for this to function.)	ON
14	"Auto Rev" Auto Weight Reverse mode (Dot/Dash spacing is reversed) (Menu 12 and 13 must be on for this selection to function.)	OFF

Menu No.	Function Description	Initial State																
16	"Bug" Selects Iambic (OFF) or Bug type operation (ON) for the electronic keyer. (Menu 12 must be ON.)	OFF																
17	"Play.int" Determines if manual input from the paddle is allowed (ON) during message keyer playback. (Menu 12 must be ON.)	OFF																
18	"Dsp.c.fil" Used to turn the DSP Comb Filter ON and OFF for SSB reception.	OFF																
19	"Dsp.r.lpf" Used to set the cut-off frequency of the DSP BPF and LPF during receiving. Note: The three BPF positions are used in the FSK mode only. The characteristics of the three filters is shown below: <table border="1" style="margin-left: 40px;"> <thead> <tr> <th></th> <th>Low Cut</th> <th>Center</th> <th>High Cut</th> </tr> </thead> <tbody> <tr> <td>BPF1 (Wide)</td> <td>Approx. 400Hz</td> <td>2200Hz</td> <td>3700Hz</td> </tr> <tr> <td>BPF2 (Med)</td> <td>Approx. 700Hz</td> <td>2200Hz</td> <td>3500Hz</td> </tr> <tr> <td>BPF3 (Narrow)</td> <td>Approx. 1300Hz</td> <td>2200Hz</td> <td>3000Hz</td> </tr> </tbody> </table>		Low Cut	Center	High Cut	BPF1 (Wide)	Approx. 400Hz	2200Hz	3700Hz	BPF2 (Med)	Approx. 700Hz	2200Hz	3500Hz	BPF3 (Narrow)	Approx. 1300Hz	2200Hz	3000Hz	2800Hz
	Low Cut	Center	High Cut															
BPF1 (Wide)	Approx. 400Hz	2200Hz	3700Hz															
BPF2 (Med)	Approx. 700Hz	2200Hz	3500Hz															
BPF3 (Narrow)	Approx. 1300Hz	2200Hz	3000Hz															
20	"Dsp.t.hpf" Used to set the cut-off frequency of the DSP analog HPF used during transmission.	200Hz																
21	"Dsp.t.lpf" Used to set the cut-off frequency of the DSP LPF used during transmission.	2750Hz																
22	"C rise" Used to set the rise and decay time of the CW waveforms generated by the DSP unit. 2/4/6/8 ms	4ms																
23	"Rec t" Sets the recording times of REC-1, REC-2 and REC-3. Two selections are possible. 8-16 : REC-1=8 sec, REC-2=8 sec, REC-3=16 sec. 16-32 : REC-1=16 sec, REC-2=16 sec, REC-3=32 sec. When 16-32 is selected, the sound quality decreases since the sampling rate is 1/2 the sampling rate of the 8-16 mode. (This selection functions only when the optional DRU-2 is installed.)	8-16																
24	"Con rec" Selects continuous recording for REC-3. Make sure this selection is OFF before turning the power switch OFF to prevent loss of recorded information.	OFF																
25	"Con.ret.t" Sets the time frame of the REC-3 continuous recording mode 8 or 16.	8																
26	"Repeat" Continuous playback of recordings	OFF																
27	"Rep t" Specifies the repetitive playback interval (seconds). Select within the range of 0 to 60 seconds.	10																
28	"Rtty.rev" FSK Reverse mode selection ON or OFF.	OFF																

4-2-13. Power ON Function Selection

You can also set and use the functions described in the table below using the following procedures:

Repeat to release each function.

1. While holding down the MENU key, turn on the POWER switch.
2. A number will appear in the display.
3. Select the desired number by rotating the M.CH/ VFO CH control.
4. Change the function by pressing the UP/DOWN keys.
5. To return to the normal display, press the MENU key.

Menu No.	Function Description	Initial State
50	"Beep" Determines whether a beep is heard each time a key is pressed (ON). Beep volume is adjustable; see 5-6-4 Beep tone level	ON
51	"Beep" Selects the type of mode announcement. Morse (ON) or Beep (OFF).	ON
52	"Beep" Select a Morse code error message (ON) or simple BEEP warning (OFF).	ON
53	"Rtty.rev" FSK Reverse mode selection ON or OFF	OFF
54	"Polarty" Selects whether a space (ON) or mark (OFF) is sent when the FSK key is closed.	OFF

Menu No.	Function Description	Initial state
55	"Rtty.tone" Selects the desired FSK shift range. 170, 200, 425, or 850Hz.	170 Hz
56	"Tty.tone" Switches between high (2125 Hz) and low (1275 Hz) tones.	2125 Hz
57	"Rpt.tone" Used to select the desired Sub-tone frequency.	88.5 Hz
58	"Con bst" Selects the desired Sub-tone type burst (b) or continuous (c).	c
59	"Agc set" Selects the AGC time constant in the AUTO position(SSB, CW). 1 = SLOW 2 = MID 3 = FAST	SSB: 1 CW: 3 FSK: ""
60	"Shift" Allows temporary adjustment of frequency in the memory channel recall mode, without affecting the contents of the memory channel when ON.	OFF
61	"Band.sel" Selects the desired memory saving mode. HALF: 1 (Frequency only) ALL: 2 (Frequency, Mode, filter,etc.) OFF	ALL
62	"Auto.inc" Allows the memory channel number to be automatically increased each time the M.CH key is pressed when ON.	OFF
63	"Step" Selects the desired frequency step size of the main tuning knob. (5kHz or 10kHz) Does not effect the tuning rate when the FINE function has been selected, or when the SSB, CW, or FSK mode has been selected. In the FM mode the selection options are 25kHz or 50kHz.	10kHz
64	"Ch step" Allows the M.CH/VFO CH control step size to be adjusted within a range of 1kHz to 10kHz. (in 1kHz increments)	9kHz
65	"Ch step" Allows the M.CH/VFO CH control step size to be 9kHz or 10kHz in the broadcast band only during AM operations.	10kHz

67	"Rit.disp" When turned on, Allows display of the RIT/XIT frequency when the RIT/XIT switch is off.	ON
68	"Rit.plus" Turns the RIT/XIT frequency change data transfer function ON or OFF. When ON, allows the frequency change data to be copied into the main display when the CLEAR key is pressed.	OFF
69	"Chatter" Turns the electronic keyer chatter suppression circuit ON or OFF. Menu 12 must be On for this menu choice to become available.	ON
70	"Cp" Sets the CW mode to SEMI when transmitting a CW message ON or OFF. Menu 12 must be ON for this menu choice to become active.	OFF
71	"Ssb auto" Turns the SSB auto mode function ON or OFF.	ON
72	"Scan hld" Turns the program scan hold function ON or OFF.	OFF
73	"Fil sel" Turns the filter limit selection function. This allows useful filter selections to be made, based upon the mode of operation. Example: No 270 Hz filter for SSB voice.	ON
74	"10 disp" Turns the 10Hz display resolution ON or OFF.	ON
75	"Scale" Sets the full scale deflection of the Analog scale to 1MHz or 100kHz.	1000 kHz
76	"Split" Allows you to disable the frequency display shift that occurs during split frequency operations.	OFF
77	"Scope" Turns the Sub receiver marker ON and OFF when using the SM-230 in the Pan Display mode, with a 100 kHz or 250 kHz resolution. The scope maker is not quite as stable as the main display and might tend to drift slightly as time goes by.	OFF
78	"Sub chg" You can set the RX→SUB key either to switch between the MAIN and SUB frequencies (CHANGE) or to transfer the Main frequency to the Sub frequency (COPY).	CHANGE
79	"Synchro" Sets whether to enable (ON) or disable (OFF) the transmitter function (A(VFO A) TX key, B(VFO B) TX key, or M.CH (memory channel) TX key when you press a receiver function key (A(VFO A) RX key, B(VFO B) RX key, B(VFO B) RX key, or M.CH (memory channel) RX key).	ON

4-2-14. Alarm Function

Two alarms have been included to signal errors that you might encounter. The chart below lists the possible causes and the resulting Morse code alarm. Morse code will be heard from the speaker.

Indication	Morse Code
When the SCAN key is pressed and the receiver is unable to execute memory scan.	CHECK
<ul style="list-style-type: none"> •When you exceed the operating limits while using the numeric keys to enter a frequency. •When the SUB frequency exceeds the operating frequency range while operating the BAND key. 	OVER

■ CW, AM, FSK Mode

[I] IF VBT control

This control is very similar to the SSB Slope Tuning controls. However, with the IF VBT control both sides of the IF passband are narrowed at the same time. The actual range depends upon the CW filters that have been installed.

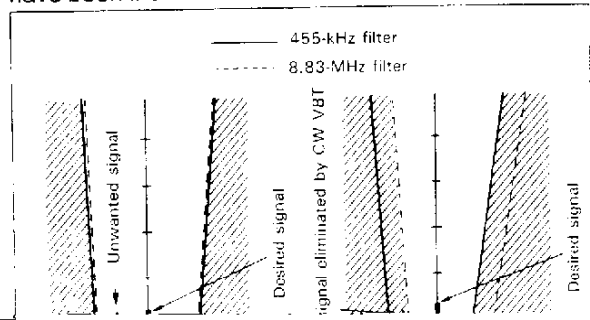

During SSB reception, these controls permit you to reduce the apparent IF filter bandwidth and therefore reduce adjacent channel interference.

● SSB SLOPE TUNE HIGH CUT control

Adjust the HIGH CUT control counterclockwise, and interference from signals higher than the operating frequency will be reduced. The high-frequency components of the resulting receiver audio will also be reduced.

● SSB SLOPE TUNE LOW CUT control

Adjust the LOW CUT control clockwise, and interference from signals lower than the operating frequency will be reduced. As with the HIGH CUT control, use of the LOW CUT control will also affect the audio frequency passband. In this case the low frequency components of the audio signal will be reduced.

Maximum bandwidth occurs with the LOW CUT control fully counterclockwise, and the HIGH CUT control fully clockwise.

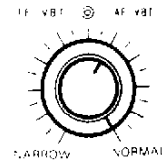
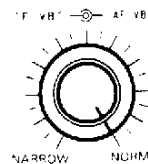
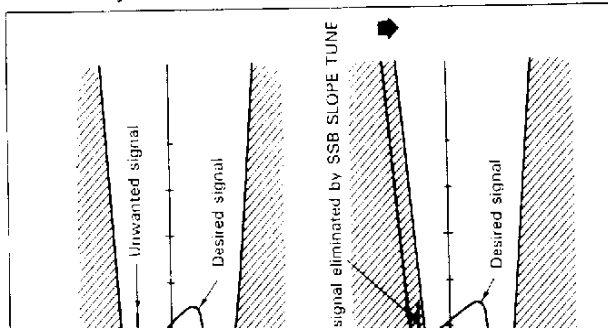

IF VBT control

[II] AF VBT switch, AF VBT control (CW only)

The AF VBT circuit is just the opposite of the NOTCH circuit. With this control it is possible to accentuate the desired signal by providing additional rejection of noise and interfering signals whose pitch (tone) falls outside the audio passband.

Turn the AF VBT switch ON and select desired audio frequency bandwidth by turning the AF VBT control. The PITCH control moves to match the AF VBT center frequency.

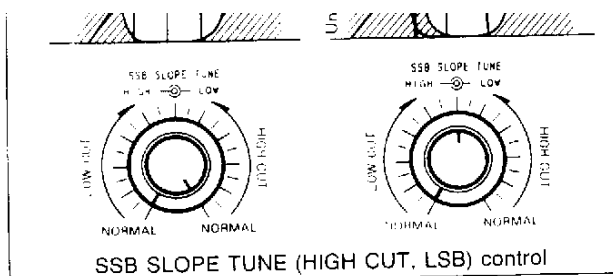
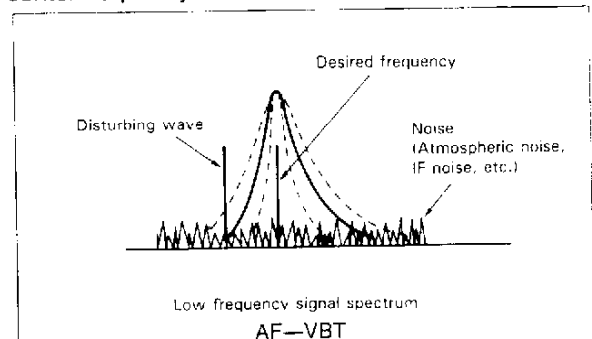

Downloaded by
Amateur Radio Directory

■ All mode

[I] Filter switch

The filter bandwidth for the 8.83 MHz and 455 kHz IFs can be selected from the front panel. Up to 3 additional filter bandwidths may be added through the installation of optional filters. (Please refer to

8.83MHz filter bandwidth

The value changes each time the 8.83 switch is pressed.

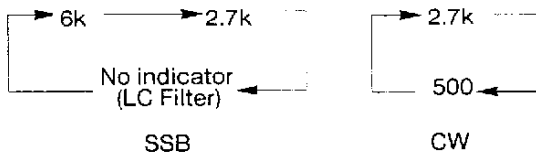

Notes

1. This function is not active in the FM mode.
2. Some bandwidths cannot be selected unless the required filter is installed.

455kHz filter bandwidth

The filter (bandwidth) indicators are switched each time the 455 key is pressed.

In the FM mode, this key serves as the deviation selection key. When the 12k indicator

[II] NOTCH control (Except FM mode)

Use this control when you are experiencing interference from a CW Heterodyne type signal. Turn the NOTCH ON and slowly adjust the NOTCH control to minimize the beat signal. A beat of approximately 1.5 kHz can be reduced at the approximate center

will not eliminate SSB, AM or FM type interference. The bandwidth of such signals is approximately 3 - 6 kHz wide. When in the USB, CW or AM mode a beat tone lower than the center frequency can be reduced by rotating the control clockwise from the center point. In LSB or FSK mode adjust the control counterclockwise.

Notes

1. The NOTCH frequency can be varied within a range of approximately 400 to 2600 Hz.
2. When an interfering signal such as a CW station appears, slowly rotate the NOTCH control. If you rotate the knob too quickly you may pass right over the notch point. Slow rotation will yield best results.

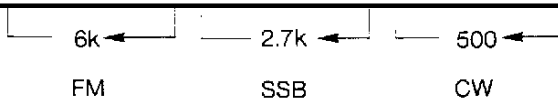
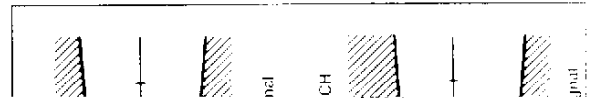

Notes

1. In the FM mode, only 12 kHz (wide) and 6 kHz (narrow) can be selected.
2. Some bandwidths cannot be selected unless the required filter is installed.

Initial state

MODE \ FILTER	8.83MHz	455kHz
SSB, CW, FSK	2.7k	2.7k
AM	6k	6k
FM	_____	6k

Note

When the bandwidth of the 8.83 MHz filter is

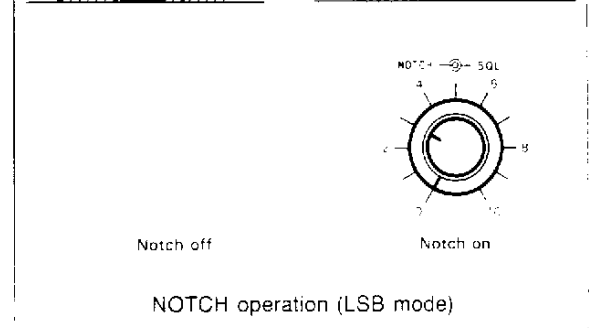

For example, when both the 8.83 MHz and 455 kHz filters are set to 2.7 kHz, the combined bandwidth will be about 2.4 kHz.

4-2-16. Noise Blanker

The MAIN receiver and the SUB receiver have their own noise blankers.

●NB 1 switch

When pulsating noise, such as that caused by automobile ignitions is encountered, place the NB 1 switch ON.

This switch will not help to eliminate atmospheric or line noises, but pulse type noise.

●NB 2 switch

Noise blanker 2 is used for long duration pulse noise, like the "woodpecker". To reduce "woodpecker" radar noise interference, set switch NB 2 to the ON position (NB 2's effectiveness depends on the specific type of interference). If you use NB 2 for short duration pulse noise, the receive tone may become distorted, making it difficult to hear.

Unfortunately no noise blanker can remove all different types of interference, but the two noise blankers that have been provided in the TS-950SDX are effective in most cases.

If there is no "woodpecker" present, the switch should be in the OFF position.

●MAIN NB LEVEL control

Controls the noise blanker operating level.
Use only the minimum level necessary.

●SUB NB LEVEL control

Controls the noise blanker operating level.
Use only the minimum level necessary.

4-2-17. RIT control

First, cancel any previously programmed offset using the CLEAR switch, then turn the RIT switch ON. The RIT control shifts the receiver frequency up to ± 9.99 kHz. Use of the RIT control will not affect the transmit frequency.

When the FINE switch is set to ON, the 10 Hz step is changed to the 1 Hz step, which makes frequency change slow.

When the RIT switch is ON, the RIT indicator will light and the receive frequency can be adjusted by using the RIT control. Pressing the CLEAR switch allows the RIT to start shifting with the receive frequency of the Main band. The offset relative to that Main band frequency will be set to 0 first. (Please refer to Section 4-2-13 No. 68.)

Note

When the RIT is ON the transmit frequency may be different from the receive frequency. For normal operation leave the RIT switch OFF. It should be used only when necessary.

4-2-18. CW-R mode

If the CW key is pressed in the CW mode, the transceiver enters the CW-R mode.

To return to the CW mode, press the CW key again.

The CW-R mode shifts the BFO from USB to LSB. In this mode the beat tone changes from low to high when the tuning control is turned clockwise to help eliminate beat frequency interference.

4-3. TRANSMITTER OPERATION

4-3-1. Precaution

Before transmitting check the frequency for activity so that you do not interrupt another QSO.

Note

All segments on the Display Panel and Indicators are shown on for this explanation.

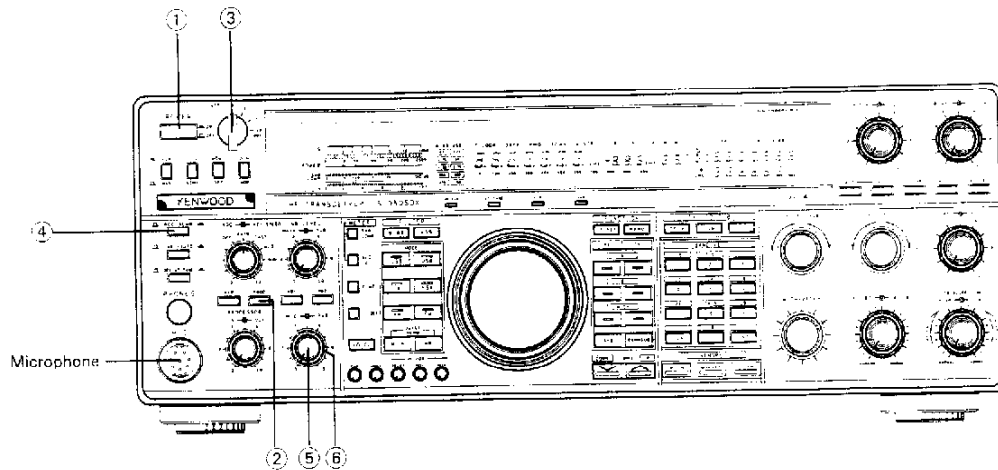

1. Set the switches and controls as follows:
 - ① POWER switch : OFF (■)
 - ② PROC switch : OFF (■)
 - ③ ATT switch : 0 dB
 - ④ REC/SEND switch : REC (■)
 - ⑤ MIC gain control : Fully counterclockwise
 - ⑥ PWR control : Fully clockwise
2. Connect a microphone to the MIC jack.

Note

The ALC meter allows you to adjust the MIC gain more accurately, compared with when using the power meter. However, be careful not to let the ALC meter deflect beyond the ALC zone. Otherwise, the distorted audio signal will be transmitted.

4-3-2. SSB Mode

1. Place the POWER switch ON.
2. Set the MODE keys to USB or LSB. By international convention frequencies below 10

7. Turn on the PROC switch if required. (Please refer to Section 4-3-7.)
8. Release the PTT switch, or place the REC/SEND switch to REC. The ON AIR indicator will turn OFF.

4-3-3. FM Mode

3. Enter the desired frequency.
- tune to the desired frequency. You can override this by simply pressing the desired mode key.

4. Set the METER switch to ALC.
5. Press the microphone PTT switch, or set the REC/SEND switch to REC. The ON AIR indicator will turn ON.

SEND switch to SEND. The ON AIR indicator will light.

Note

The transmitter will not operate unless the FULL/SEMI switch is in the FULL position.

6. Speak into the microphone and adjust the MIC gain control so that the meter deflection does not exceed the ALC zone on voice peaks.

6. Speak into the microphone, holding the microphone about 5 cm away from your mouth. Close talking or talking too loudly may reduce transmission clarity.
 7. Release the PTT switch, or place the REC/SEND switch to REC. The ON AIR indicator will turn OFF.
- When the 12k indicator is on, the 12 kHz filter is selected with ± 5 kHz deviation. When the 6k indicator is on, the 6 kHz filter is selected with ± 5 kHz deviation.

4-3-4. AM Mode

1. Place the POWER switch ON.
2. Place the AM key.
3. Enter the desired frequency.
4. Set the METER switch to ALC.
5. Press the microphone PTT switch, or set the REC/SEND switch to SEND. The ON AIR indicator will light.
6. Adjust the CAR LEVEL control so that the meter indicates 40 watts.

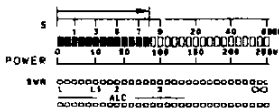

7. Speak into the microphone and adjust the MIC gain control so that the meter indicates 80 watts.



8. Release the PTT switch, or place the REC/SEND switch to REC. The ON AIR indicator will turn OFF.

4-3-5. FSK Mode

1. Connect the RTTY keyboard to the FSK key jack on the rear panel.
2. Place the POWER switch ON.
3. Place the FM key.
4. Select the desired FSK shift. (See section 4-2-13.)
5. Enter the desired frequency.
6. Set the METER switch to ALC.
7. Set the REC/SEND switch to SEND. The ON AIR indicator will light.
8. Adjust the PROCESSOR-OUT control so that the meter deflection is within the ALC zone.
9. Operate the RTTY keyboard.
10. Place the REC/SEND switch to REC. The ON AIR indicator will turn OFF.
11. Follow the instructions contained in RTTY keyboard operating manual for the correct settings before you start transmitting. The DATA mode will be automatically selected in the FSK mode. The shift range can be selected in the POWER ON function selection. (Please refer to Section 4-2-13.)

4-3-6. CW Mode

● Sidetone oscillator

The transceiver contains a sidetone oscillator circuit to permit you to monitor your own signal. If the key is closed in CW with the VOX/MAN switch set to MAN, transmit will not be selected, but a sidetone will be heard from the speaker to allow Morse code training. The volume of the sidetone can be adjusted internally (Please refer to Section 5-6-3).

1. Connect a key or an electronic keyer to the rear panel CW KEY jack.
2. Place the POWER switch ON.
3. Place the CW key.
4. Enter the desired frequency.
5. Set the METER switch to ALC.
6. Press the REC/SEND switch to select SEND. The ON AIR indicator lights, showing that you are now in the transmit mode.
7. Press the key, the ON AIR indicator lights and the meter pointer deflects.
8. Adjust the CAR LEVEL control until the meter deflection is within the ALC zone.

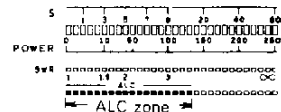

9. Release the key. The receive mode will be restored and the ON AIR indicator will turn off.

■ SEMI and FULL break-in

[I] Keyer connections

When the internal keyer is turned off and you intend to use either a straight key or an external keyer you should connect the plug as shown in the accompanying diagram. Use a plug with a diameter of 6.0 mm.

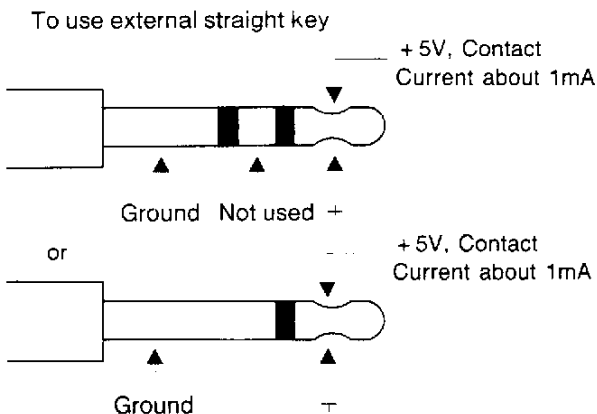

Notes

1. When using a key or an external electronic keyer, set the MENU key to ON, select menu number 12 with the M.CH/VFO CH control, and set the display OFF with the UP / DOWN switches. To restore the previous operating state, press the MENU key again. Initially, the display is OFF.
2. Use of a stereo plug in this instance will cause misoperation of the transceiver.
3. Use a shielded cable or a coaxial cable to connect the plug and the keyer.

[II] Electronic keyer connection

When using the internal keyer you should connect the CW key as shown in the accompanying diagram. Note internal keyer operation requires the use of a stereo type plug (6.0 mm dia.), do not use a mono plug when internal keyer operation is desired.

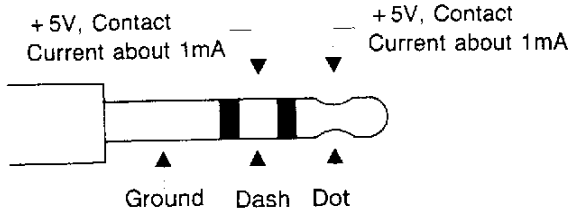

[III] Electronic Keyer Circuit Operation

Set the MENU key to ON and select menu number 12 with the M.CH/VFO CH control. Set the display to ON with the UP/DOWN switches. Then press the MENU key again.

Connect a paddle type key to the key jack using a 6.0 mm diameter stereo plug. Adjust the KEY SPEED control for the desired speed.

■ Weight Adjustment

The ratio of dot / space / dash can be adjusted as follows:

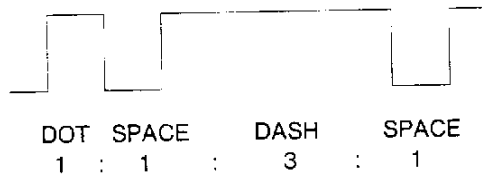

The Dot-Dash ratio has been factory preset to 1 : 3 and will remain so regardless of the keyer speed. You can forceably change the ratio to your own personal preference or you can select AUTO-WEIGHT control where the weighting adjusts for changes in keyer speed.

Set the MENU key to ON and select a menu number with the M.CH/VFO CH control. Change the setting with the UP/DOWN switches.

MENU No.13 selects Auto/Manual setting ON/OFF. MENU No.14 selects Reverse mode setting ON/OFF. MENU No.15 selects the manual weight 1~3.

Speeds at which the dot/dash ratio changes are as follows.

Menu No.14	KEY SPEED Control Position		
	0~3	3~7	7~10
OFF	1:2.8	1:3.0	1:3.2
ON	1:3.2	1:3.0	1:2.8

Notes

1. Since the dot/dash ratio changes at positions 3 and 7 of the KEY SPEED control where some hysteresis occurs, it requires a little time to change the dot/dash ratio.
2. The dot/dash ratios are approximate.

Auto Adjustment

Three dot/dash ratios can be set by using Menu No.14 and KEY SPEED Control Position.

MENU No.14	
OFF (Normal mode)	ON (Reverse mode)
The faster the keying speed the longer the dash.	The faster the keying speed the shorter the dash.

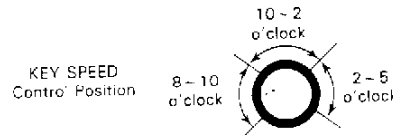

KEY SPEED Control Position	8~10 o'clock	10~2 o'clock	2~5 o'clock
NORMAL MODE	1:2.8	1:3.0	1:3.2
REVERSE MODE	1:3.2	1:3.0	1:2.8

Manual Adjustment

1. Press the MENU key.
2. Select menu number 15 using the M.CH/VFO CH control. The currently set weight value appears in the sub-band frequency display area.
3. Select the desired value in the range 1:2.5 to 1:40 using the UP or DOWN switch.
4. Press the MENU key again to complete the setting operation.

Note

It requires a little time to change the ratio at about the 10 o'clock and 2 o'clock positions of the KEY SPEED control where some hysteresis occurs.

■ SEMI and FULL break-in operation

Note

When using a keyer, set the MENU key to ON, select menu number 12 with the M.CH/VFO CH control, and set the display OFF with the UP/DOWN switches. To restore the previous operating state, press the MENU key again. Initially, the display is OFF.

Two break-in methods are provided with the transceiver, SEMI and FULL break-in. With either break-in operation depressing the CW key will cause the transceiver to transmit without the need for manually switching the REC/SEND switch. The difference between FULL and SEMI break-in is that during FULL break-in operation it is possible to listen between dots and dashes, and that during SEMI break-in it is not.

Note

With either SEMI or FULL break-in operation, cross band/cross mode operation is not possible. Additionally, when you are using FULL break-in you should not work cross band splits, only in the same band.

The transceiver also provides a sidetone oscillator circuit to allow monitoring of your CW signal during transmission.

(a) SEMI-automatic break-in

Depressing the CW key will automatically place the transceiver into the transmit mode. Transmit mode will be maintained for a period determined by the setting of the DELAY control on the front panel of the transceiver, even after the CW key is released.

(b) FULL-automatic break-in

Depressing the CW key will automatically place the transceiver into the transmit mode. Releasing the CW key will return the transceiver to receive immediately enabling reception between characters.

On occasion an electronic keyer may be used that has no method of producing a continuous transmit condition. In order to obtain a continuous carrier for tuning simply place the REC/SEND switch to the SEND position, and the CW switch to FULL.

Cautions

1. The TL-922 / 922A linear amplifier is not designed for full break-in type operation. Attempting to use this accessory in the FULL break-in mode may cause damage to the

4-3-7. Speech Processor

The Speech Processor is used when signals from your station are weak at the distant station. During SSB operation (especially DX operations), it may be desirable to increase the relative "talk-power" of the transmitter by using the speech processor circuitry. This may make the difference between a marginal, and a copyable signal.

● **Operation**

Turn the PROC switch ON and place the METER switch to COMP. Adjust the PROCESSOR IN control while speaking into the microphone in a normal tone of voice, for a peak COMP scale reading of no more than 10 dB. Do not overdrive the COMPRESSOR. This will deteriorate voice quality, increase transmitter noise level, and in general make copying your signal more difficult.

Next, set the METER switch to ALC and adjust the PROCESSOR OUT control while speaking into the microphone. Ensure that the meter deflection is within the ALC zone!

4-3-8. VOX Operation

Depress the VOX switch. While speaking into the microphone, increase the GAIN control until the VOX relay just operates. Clockwise rotation of this control will increase the sensitivity. For VOX operation it is sometimes desirable to "Close-Talk" the microphone in order to prevent background noises from tripping the transmitter.

1. Check that the ALC reading on voice peaks is still within the ALC zone on the meter. If necessary, readjust the MIC gain control for the proper ALC reading.
2. If the VOX circuit is activated by the output from the speaker, adjust the ANTI control as necessary for proper VOX operation.

Notes

1. Do not use excessive VOX or ANTI VOX settings. This may cause the VOX circuit to operate erratically. Use only the necessary control settings.

convenient when you are adjusting a linear amplifier.

4-3-9. ON AIR Monitor

[I] MONI switch

Turn the MONI switch ON to monitor the transmitted signal.

Note

With the MONI switch ON, Turning the TUNING control or the TX VFO/SUB control generates a switching noise in the speaker.

[II] MONI control

Adjust monitor volume level.

Unlike conventional IF monitor circuits, the monitor circuits of this transceiver (with the exception of FM) enable you to monitor signals under actual operating conditions as shown below.

Note

AGC in the SUB receive unit is activated automatically so that you can obtain a constant volume level regardless of transmitter output power.

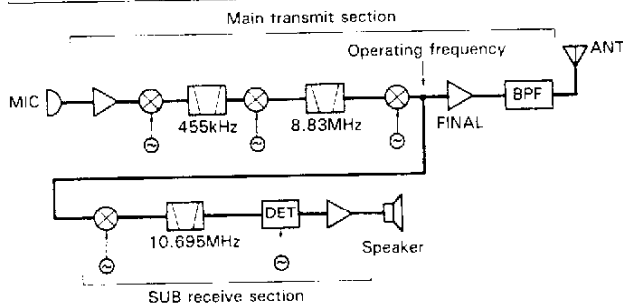

In the FM mode you can check for over modulation

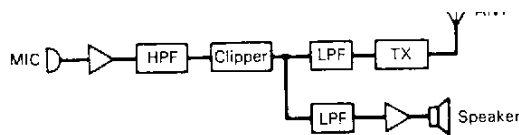

4-3-10. XIT control

Transmitter Incremental Tuning is very similar to

function.

Offsets of ± 9.99 kHz are possible.

When the FINE switch is set to ON, the 10 Hz step is changed to the 1 Hz step, which makes frequency change slow.

The RIT/XIT offset can be preset, without affecting the actual operating frequency by turning OFF the XIT/RIT and using the RIT/XIT display to determine the offset.

4-3-11. SPLIT Frequency Operation

Different frequencies can be set for VFO A, VFO B and for memory.

For example:

VFO A is the active VFO, and VFO B is the inactive VFO. Pressing the TX VFO B key will cause the transceiver to receive on VFO A and transmit on VFO B. The mode of reception and transmission will follow the mode contained in the appropriate VFO. It is possible to work cross band, cross mode if desired.

To avoid confusion during contest or pile-up operations, We recommend using VFO A for receive and VFO B for transmit.

● TF-SET key

Depressing this key will allow you to rapidly set or check the transmit frequency, during SPLIT operations, without the need of actually transmitting.

This key is especially convenient when you are trying to locate the transmit frequency of the station currently in contact with the DX station, since depressing this key allows you to receive on the transmit frequency as long as the key is held depressed. The TUNING knob is active when this key is depressed, so it is easy to change your

4-3-12. RTTY

RTTY operation requires a demodulator and a teletypewriter. A demodulator including 2125 and 2295 Hz (170 Hz shift) filters, will be acceptable and may be connected directly to the PHONE PATCH OUT jack. To use the transceiver's FSK circuit with older high voltage teletype equipment, you must use an external keying relay in the teletypewriter closed loop, and connect the relay contacts to the

RTTY SYSTEM

This transceiver will adapt to Slow Scan Television or AFSK (Audio Frequency Shift Keying) RTTY operation.

For SSTV, the PHONE PATCH IN jack should be connected to the Camera output. The PHONE PATCH OUT jack should be connected to the monitor input. For AFSK operation, connect the

Tone Unit output to the Phone Patch input, and Phone Patch output to the Tone Unit input.

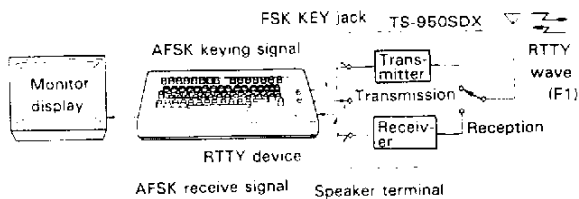

The figure below shows the frequency relationship between receive and transmit with this transceiver. In FSK operation the space frequency is indicated on the main display.

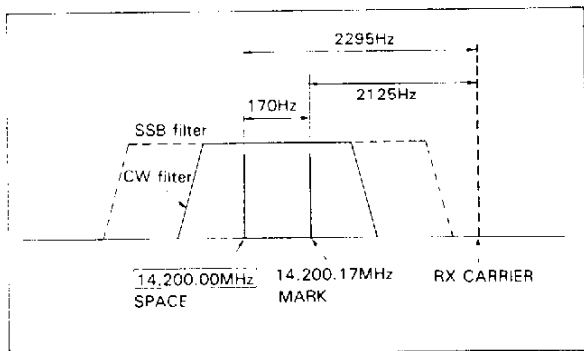

Note
Main display frequency 14.200 MHz.

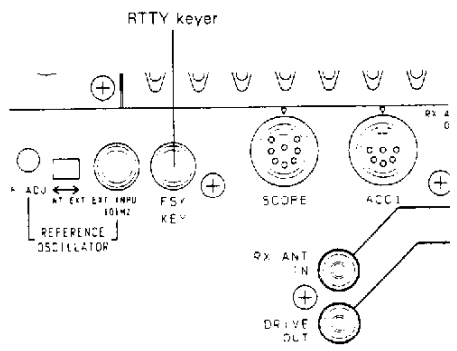

4-3-13. Auto Antenna Tuner Operation

If the transceiver is operated into an antenna with a high SWR, the final stage SWR protection circuit may operate (when SWR is greater than approximately 2 : 1). Use of the Automatic Antenna Tuner will help you to match the antenna to the transceiver. The AT unit is capable of matching a 20 - 150 ohm load, or approximately a 3 : 1 SWR. If the antenna and feed line exceed this range the tuner may not be able to find the correct match. If the tuner cannot match after two attempts, check your antenna and feed lines.

Output power of the transceiver will automatically be set to approximately 10 watts during the tuning process to protect the finals against damage.

While the automatic antenna tuner is capable of reducing the apparent SWR of the antenna system, it is important to remember that maximum power output will only occur when the antenna has been adjusted for the lowest possible SWR.

Auto tuning Mode

1. Press the THRU/AUTO switch to select AUTO.
 2. Press the AT TUNE switch.
 3. The transceiver enters the CW mode, the AT TUNE indicator lights, showing that tuning is started.
 4. When tuning is completed, the AT TUNE indicator goes off.
- If tuning is not completed in 20 seconds, you will hear a beep.

Note

When you use this function for the first time, you may not succeed in tuning. In this case, turning the AT TUNE switch ON and OFF several times may allow the appropriate tuning.

5. Press the AT TUNE switch again to release it. The transceiver returns to the receive mode.

Manual Tuning Mode

1. Press the MENU key.
2. Select menu number 08 using the M.CH/VFO CH control.
3. Select OFF using the UP or DOWN switch, and then press the MENU key again to enter the manual mode.
4. Press the THRU/AUTO switch to select AUTO.
5. Press the AT TUNE switch.
6. Adjust the tuning knob and the TX VFO / SUB control while observing the SWR meter so that the SWR value is minimized.

When tuning is completed, the AT TUNE indicator goes off, and the newly set data is stored in the memory as the preset data.

After the indicator has gone off, you cannot perform tuning using the controls.

If you press the AT TUNE switch during tuning operation, the data selected at that time is stored in the memory as the preset data.

7. Press the AT TUNE switch again to release it. The transceiver returns to the receive mode.

Note

If you cannot lower the SWR value even in the manual mode, adjust the SWR value of the antenna.

■ **Preset Memory**

This transceiver has a Preset Memory function capable of storing tuning conditions of each amateur transceiver band. The transceiver stores the tuning conditions after tuning of an amateur transceiver band is completed, and automatically provides the stored tuning conditions when switched back to that amateur transceiver band from other amateur transceiver bands, reducing the time for tuning. When you switch to an amateur transceiver band, the AT TUNE indicator lights briefly to indicate that the Preset function is operating. When this transceiver is shipped from the factory, the transceiver's tuning is preset by connecting a 50-Ohm dummy load to the antenna connector.

Note

After tuning is complete, if you change BANDS and then return to the previously tuned BAND, the SWR may have changed. If the SWR has changed, set the AT TUNE switch to ON so the unit will retune.

4-3-14. Data Communications (PACKET, AMTOR, RTTY, SSTV, etc.)

- ACC 2 terminal has been provided for connection of Data communications devices. All necessary connections can be accomplished from the same connector.
- When using AFSK (Audio Frequency Shift Keying) or modulating the signal with any form of audio tones you should select LSB or USB. If F2 operation is desired select the FM mode. In general LSB is used for RTTY and PACKET communications in the HF band (F1), and USB is used for AMTOR.
- The transceiver will transmit according to the signals received on the STBY pin of the connector. These inputs are generated by the terminal unit in response to inputs from the associated terminal input device.
- When using LSB, or USB the MIC gain control should be used to adjust the input level for an on scale ALC meter reading.
- Pin number 9 of the ACC 2 connector is used to disable the front panel microphone connector during the periods that your communication terminal is in use (grounding the pin accomplishes this task). This prevents unwanted errors from entering your text.

Notes

1. No transmission should be attempted until you have confirmed that all terminal unit connections have been properly completed according to the instructions provided with that unit.
 2. If the output of the terminal unit causes the ALC meter to register above the recommended limits even with the MIC gain control turned all the way down, you should reduce the output of the terminal unit. Excessive signal levels can cause distortion! If the terminal unit output level is fixed you should add a potentiometer between the transceiver and the terminal unit. (Refer to Section 5-6-5.)
 3. The DATA mode will be automatically activated in the FSK mode.
- When the DATA mode is selected, the microphone input circuit is disabled and the signals from the microphone will be blocked. Using the standby terminal (Pin number 9 of the ACC2 connector) will produce the same result. When the REMOTE connector is used for external standby, prevent unwanted errors by pressing the DATA mode to disable the mic input circuit. When the DATA mode is selected in the FM mode, the time constant for the squelch becomes fast.

4-4. MEMORY

The transceiver incorporates a convenient 100 channel memory that can be used to store and recall commonly used frequencies.

4-4-1. Microprocessor back-up lithium Battery

A lithium battery is contained in the transceiver to retain memory. Turning off the POWER switch, disconnecting the power cable, or a power failure will not erase the memory. The battery should last for approximately five years. When the battery discharges, an erroneous display may appear in the display. Lithium battery replacement should be performed by an authorized KENWOOD service facility, either your KENWOOD dealer, or the factory, since this unit contains CMOS type circuitry.

Notes

1. When the lithium battery is replaced, the microprocessor must be reset, using the procedure in section 4-4-2.
2. All user programmed memory will be erased with this operation.

4-4-2. Initial State and Reset of the Microprocessor

A. Initial state of the microprocessor from the factory.

	Frequency	Mode
VFO A	14.000.00	USB

4-4-3. Memory Channel

Memory Channel Number	Memory Channel
00 through 89	Standard and Split
90 through 99	Programmable VFO Tuning limit

4-4-4. Memory Contents

Each Memory Channel is capable of storing the following information.

	00~89	90~99
Frequency	Yes	Yes
Mode	Yes	Yes (*2)
Filter	Yes	Yes (*2)
Tone Frequency data	Yes(*1)	No
Highest/Lowest operating frequency	No	Yes
AIP ON	Yes	Yes (*2)

- *1 When the memory is used as a split memory in FM mode for both transmission and reception.
 *2 During memory channel operation, the modified contents are saved as the memory channel data.

4-4-5. Memory Entry

Memory Channel	No data	
00~99		

B. Microprocessor reset

There are two methods for resetting the microprocessor.

- [I] Press and hold the A=B key and turn on the POWER.

Caution

All user programmed memory will be erased with this operation.

- [II] Press and hold the VFO-A(RX) key and turn on the power to reset all user programmed data except the contents of the Memory Channels.

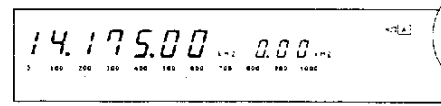

2. Press the M.IN key. The transceiver will enter the Memory Scroll (M.SCR) mode.

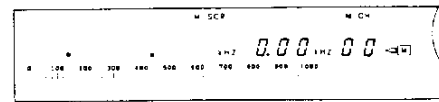

(When Memory Channel 00 is empty.)

3. Select the desired Memory Channel number.



4. When the desired memory channel is found and displayed, press the M.IN key again. The current frequency and mode will be stored, the Memory Scroll mode will be canceled, and the transceiver will return to the operating mode and frequency that was displayed before the M.IN key was pressed initially.

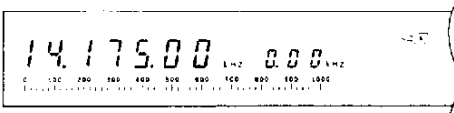

B. Split Memory Channel

1. Select the receive frequency and the mode.
Example : 21.200 MHz is selected on VFO A.

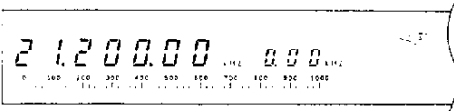

2. Press the A=B key.
3. Set the TX VFO to B and select the desired transmit frequency.
Example : 21.210 MHz is selected on VFO B.

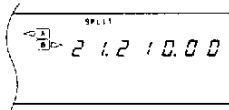

4. Press the M.IN key.

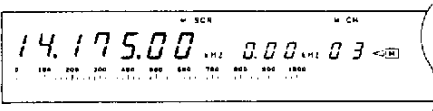

(When 14.175 MHz is stored in Memory Channel 03.)

5. Select the desired Memory Channel number.

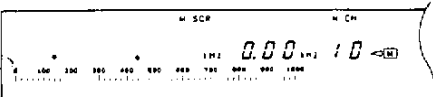

The current frequency and mode will be stored, the Memory Scroll mode will be canceled, and the transceiver will return to the operating mode and frequency that was displayed before the M.IN key was pressed initially.

C. Programmed Scan Memory Channel

The highest and lowest frequency are stored in this memory channel. The mode and filter bandwidth settings of the lowest frequency are also stored. This channel can be used as a standard memory channel if the highest and lowest frequencies are identical.

1. Select the lowest operating frequency and the mode.
Example : 7.030 MHz is selected on VFO A.

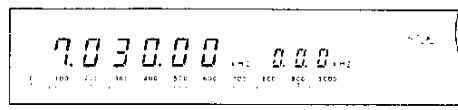

2. Press the A=B key.
3. TX VFO key ON.
4. Select the highest operating frequency using the TX VFO/SUB control.
Example : 7.100MHz is selected on VFO B.

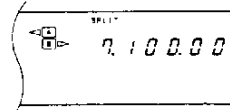

5. Press the M.IN key.

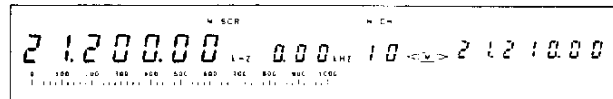

(When 21.200 MHz (RX) and 21.210 MHz (TX) are stored in Memory Channel 10.)

6. Select the desired Programmed Scan Memory Channel number (90-99ch)

(When Memory Channel 90 is empty.)

6. When the desired program scan memory channel is found and displayed, press the M.IN key again.



The current frequency and mode will be stored, the Memory Scroll mode will be canceled, and the transceiver will return to the operating mode and frequency that was displayed before the M.IN key was pressed initially.

These memory channels can have a variable range like another VFO by storing the upper and lower frequency limits in memory. The frequency is varied with the Tuning Knob.

4-4-6. Memory Channel Recall

The following procedure describes how to recall a memory channel.

1. Select memory channel operation for either RX or TX by simply depressing the appropriate FUNCTION keys. The display will indicate the frequency of the memory channel you used last.
2. You can select a different memory channel by rotating the M.CH/VFO CH control. The memory channel indicator and the frequency in the appropriate display will change as this control is rotated.

4-4-7. Memory Channel Scroll

Scroll. The M.SCR indicator lights, and the Memory Channel Frequency is displayed. Although the displayed frequency will change, actual reception will be at the previous frequency (that is, the frequency before the M.IN key is pressed).

2. Select a Memory Channel using the M.CH/VFO CH control or numeric keys. The frequencies stored in the Memory Channel will be displayed.
3. Cancel the Memory Scroll operation, by pressing the CLR key.

4-4-8. Transferring Memory Information to the VFO

The following procedure transfers the contents of the selected memory channel to the VFO.

1. Select memory channel operation for either RX or TX using the FUNCTION keys.
2. Press the M → VFO key. This will cause the contents of the memory channel to be transferred to the unused VFO position.

- (1) Pressing the M → VFO key will shift the memory channel data to VFO A when using a standard memory channel.
- (2) Pressing the M → VFO key will cause the RX frequency to be shifted into VFO A and the TX frequency to be shifted into VFO B when using a Split Frequency Memory Channel.
- (3) Pressing the M → VFO key will cause the memory channel data to be transferred to the unused VFO when using a memory channel for RX or TX and a VFO channel for the other function.

Notes

1. When the M → VFO key is pressed, the contents of the VFO are cleared but the contents of the Memory Channel will not be cleared.
2. If nothing is stored in the selected Memory Channel, only the channel number is displayed; no transfer is carried out.

4-4-9. Checking the Highest and Lowest Scan frequencies

It is possible to check the frequencies that are stored in the program scan memory channels by using the following procedure.

1. Select M.CH operation for RX.
2. Select the desired Program Scan memory channel by rotating the M.CH/VFO CH control.
3. Press the 1 MHz UP switch to see the upper scan limit.
4. Press the 1 MHz DOWN switch to see the lower scan limit.
5. If you decide after viewing that you wish to utilize this scanning range simply press the M → VFO key to transfer the data to the VFO, and

modes and filters can be changed during memory channel operation, but, with the exception of the transmit / receive frequencies, the contents of memory channels for the selected memory channel cannot be changed.

4-4-11. Clearing a Memory Channel

To erase a specific Memory Channel, press and hold the CLR key for approximately 2 seconds.

4-4-12. Quick Memory Channel

● Memory entry during VFO operation.

1. Select the receive frequency, the mode and the filter.
2. Press the QUICK MEMO M.IN key. The data is written to quick memory channel 1.

Note

If either the RX VFO or the TX VFO or both are in the M.CH mode, data cannot be written.

3. This is a stacking memory. If there is already data in channel 1, it is moved automatically to channel 2. If there is data in channel 2, it is moved automatically to channel 3 and so on. If there is data in channel 5, it is erased automatically.

● Memory entry with the Quick Memory Channel operation.

1. When the quick memory channel is recalled, the frequency, the mode, or other data in the memory channel can be modified.
2. To store the modified frequency or the mode in memory, press the QUICK MEMO M.IN key. The contents of the memory channel are replaced with new data. The original contents of the memory channel are automatically moved to the next memory channel. For example, if channel 3 is recalled, the frequency or the mode modified, and the QUICK MEMO M.IN key pressed, the new data is stored in channel 3, and the original contents of the memory channel are automatically moved to channel 4. If channel 5 is recalled, the frequency or mode modified, and the QUICK MEMO M.IN key pressed, the new data is stored in channel 5, and the original contents of channel 5 are automatically erased.

● Quick Memory Channel Recall

If the MR key is pressed and the M.CH/VFO CH control turned, a quick memory channel can be recalled. The frequency and mode can be modified, but if you move to another channel or VFO and then return to the original channel, the frequency and mode return to the original values stored in the memory channel. To return to VFO operation, press the MR key again. To shift the quick memory channel contents to the VFO, press the M→VFO key.

Note

If all quick memory channels are empty, nothing happens even when the QUICK MEMO MR key is pressed.

4-5. SCAN

Both Memory Scan and Program Scan are possible.

4-5-1. Memory Scan

During memory channel operation, pressing the SCAN key will cause the radio to scan the memory channels repeatedly, skipping the channels that have no data stored.

To cancel scan press the CLR key.

4-5-2. Group Scan

To initiate memory scan of specific memory channel groups.

1. During memory channel operation, press and hold the SCAN key.
2. You may specify which memory groups you want to scan by depressing the key that corresponds to the ten position of the memory channel group.

0	Memory channels 00 through 09
1	Memory channels 10 through 19
2	Memory channels 20 through 29
.	.	.
.	.	.
9	Memory channels 90 through 99

In example 1 we want to scan only Group 2, so we would press the 2 key. In example 2 we want to scan Group 1 and Group 3, so we would press the 1 key and then the 3 key.

2. Select the Memory Channel that you want to skip using the M.CH/VFO CH control, or numeric keys.
3. Press the CLR key.

Note

Holding the CLR key depressed for longer than 2 seconds will clear that channel all data.

4. A decimal point will appear in the memory channel display to indicate that the channel will be skipped.
5. To cancel the lockout, select the desired channel and then press the CLR key. The decimal point will go out indicating that the channel will again be scanned.

4-5-4. Programmable Band Scan

Pressing the SCAN key during VFO A or VFO B operation starts the scan.

Channel Selection

1. While holding the SCAN key depressed press the numeric key that corresponds with the program scan range you want to scan.
For example press the 3 key if you want to scan between the limits specified in memory channel 93. Press 4 if you want to scan between the limits specified in memory channel 94, and so on.
2. Scan will proceed from the frequency that appears in the main display towards the frequency specified in the sub display.
3. The mode of operation and filter bandwidth can



Example 2

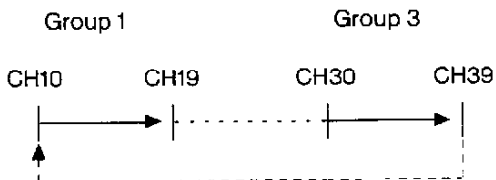

Note

If no data has been stored in memory channel 90 through 99, the programmable scan limits will be automatically stored in the memory channel 90 as follow.

Lower scan limit

10kHz

Upper scan limit

30MHz

You can specify up to 10 different groups to scan. Simply hold the scan key depressed and press the numeric key corresponding to the different groups you wish to scan.

4-5-3. Memory Channel Lockout

This transceiver has a Memory Channel lockout function which allows you to temporarily skip unwanted Memory Channels during memory scan. Locking out unwanted channels will help to increase the effective scan speed.

1. Use memory channel for the RX VFO or the TX VFO or both during memory channel operations. The display shows the memory channel operated last.

For example:

When 14.000 MHz (lower limit) and 14.010 MHz (upper limit) are stored in channel 91, and 21.000 MHz (lower limit) and 21.010 (upper limit) are stored in channel 92.

- [I] Press Numeric key 1 while holding down the SCAN key. Scanning will proceed through the range stored in memory channel 91.

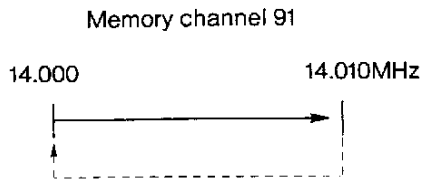

- [II] Press Numeric key 2 while holding down the SCAN key. Scanning will proceed through the range stored in channel 92.

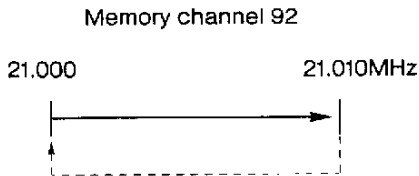

- [III] Press Numeric keys 1 and then 2 while holding down the SCAN key. Scanning will be repeated within the ranges stored in channels 91 and 92.

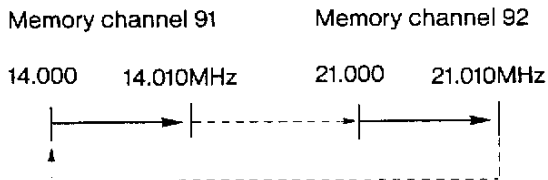

4-5-5. Sub Programmable Band Scan

1. Press the SUB key.

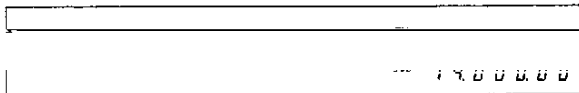

2. Press the M/S key.
The SUB indicator lights to indicate that all function of the Sub band function are active.

3. Press the SCAN key.
The lowest frequency is displayed in the main frequency display area and the highest frequency is displayed in the sub frequency display area.

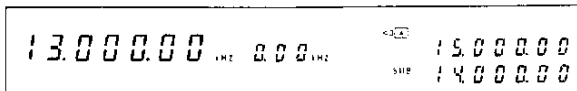

Note
The displayed highest (lowest) frequency may not be 1MHz higher (lower) than the Sub receive frequency depending on the selected band.

4. Using ENT and numeric keys, select the Main frequency to the lowest frequency.
Example: 14.100 MHz (Lowest frequency).

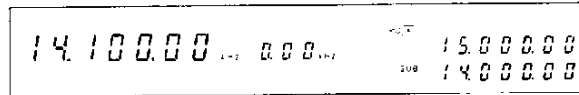

5. Using ENT and numeric keys, select the Sub frequency to the highest frequency.
Example: 14.200 MHz (Highest frequency).

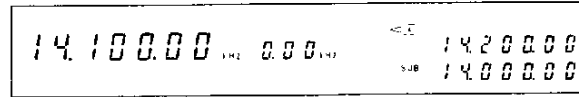

6. Press the SCAN key.
The Sub receive frequency is scanned between the lowest frequency (set in step [4]) and highest frequency (set in step [5]).
Example: The Sub frequency is scanned between 14.100 MHz and 14.200 MHz.

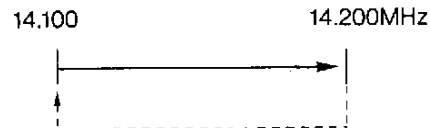

7. To return to the VFO mode, press the CLR key, and then press the SUB key.

4-5-6. Scan Speed

The scanning speed is adjustable from the front panel by using the RIT/XIT control during SCAN operations. Clockwise rotation increases the scan speed and counterclockwise rotation decreases the

both VFO and M.CH scan modes. Once set the scan speed remains in memory until it is again changed by the RIT/XIT control. You must be in the SCAN mode in order to alter the scan speed.

The approximate scan speed adjustment range is shown below.

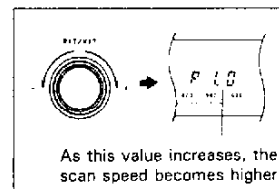
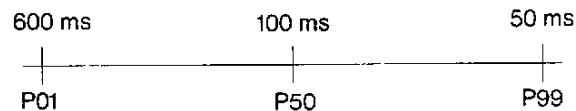

4-5-7. Scan Hold

The Scan Hold function is selected by using the Power on function selection described in Section 4-2-13. (Menu No. 72)

4-6. CW MESSAGE FUNCTION

CW messages to be transmitted can be recorded and played back.

Note

This function does not work if the transmit mode is different from the receive mode. If the POWER switch is turned off during recording or playback, the recorded or stored data may be lost.

Example: When the REC1 key is pressed.

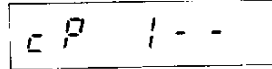

5. When the playback ends, the transceiver returns to its normal state.

Note

When the CLR key is pressed during playback, the transceiver returns to its normal state.

memory.

Note

The CW message can only be entered into memory when the built-in electronic keyer is used. It cannot be put in memory with an external electronic keyer or key.

Connect a paddle to the rear panel CW KEY jack.

1. Set the MODE key to CW.
2. Set the MENU key to ON and select menu number 12 with the M.CH/VFO CH control. Set the display ON with the UP/DOWN switches. Then press the MENU key again.
3. Set the VOX/MAN switch to MAN. Set the FULL/SEMI switch to SEMI.
4. Set the REC/PLAY switch on the Quick Key board to REC.
5. Press the REC1, REC2, or REC3 key.
Example: When the REC1 key is pressed.

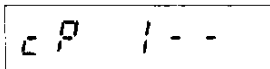

6. When a CW message is sent with the paddle, it is automatically stored into memory.
7. When the CLR key is pressed, memory storage is terminated, and the transceiver returns to normal.

Note

When the message length exceeds approximately 80 ~ 100 characters, memory storage is terminated, and the transceiver returns to its normal state.

4-6-2. Playback Method

Connect a paddle to the rear panel CW KEY jack.

1. Select the receive mode.
2. Set the VOX/MAN switch to MAN.
3. Set the REC/PLAY switch on the Quick Key board to PLAY.
4. Press the PLAY key for the desired channel to start playback.

1. Set the VOX/MAN switch to MAN.
2. Set the REC/PLAY switch on the quick keyboard to PLAY.
3. Press the desired PLAY key to start transmission.
4. When the transmission is completed, the radio will automatically return to the receive mode.

■ In the transmit mode

Press the desired PLAY key to start transmission.

4-6-4. Continuous Playback

Up to three channels can be played back continuously.

Example: When PLAY1, PLAY2, and PLAY3 are pressed successively during playback.

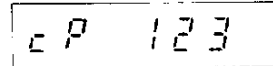

When PLAY1 transmission is completed.

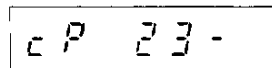

Downloaded by

Amateur Radio Directory

4-7. VOICE RECORDING USING DRS FUNCTION

(When the optional DRU-2 digital recording unit is installed)

Notes

1. If the CLR key is pressed during recording the contents are all erased.
2. If the recording time elapses during recording, the DRU-2 automatically stops recording and returns to the previous operating state.

transceiver, microphone audio can be recorded in a manner very similar to the CW message function.

■ MENU No.23

Changing the recording time

1. Press the MENU key.
2. Adjust the M.CH/VFO CH control to select menu number 23. The SUB frequency display will then show the initial setting.
8-16 : REC1 / REC2 / REC3 = 8 / 8 / 16 seconds
16-32 : REC1 / REC2 / REC3 = 16 / 16 / 32 seconds
3. Use the UP/DOWN switches to select the desired setting.
4. Press the MENU key again to complete this MENU operation.

4-7-1. Recording Method

The message to be transmitted is recorded with your normal microphone.

1. Select the desired mode.

Note

This function is disabled during FSK and TUNE operations.

2. Set the VOX/MAN switch to MAN.
3. Set the REC/PLAY switch on the quick keyboard to REC.
4. Press REC1, REC2, or REC3.
Example: When REC1 is pressed.

A rectangular display box containing the text "RP 1--".

5. Press the same REC key again. Recording occurs while the key is held down (Initial setting: REC1 : 8 seconds, REC2 : 8 seconds, REC3 : 16 seconds)
Example: pressing the REC1 switch.

A rectangular display box containing the text "RP 100".

↑
07→06→06...00

6. To stop recording, release the REC key.
This returns the DRU-2 to the previous operating state.

4-7-2. Playback Method

1. Set the receive mode.
2. Set the VOX/MAN switch to MAN.
3. Set the REC/PLAY switch on the quick keyboard to PLAY.
4. Press the PLAY key corresponding to the REC key used for recording, so that the DRU-2 reproduces the sound.

Example: To reproduce the sound recorded with the REC1 key, press the PLAY1 key.

A rectangular display box containing the text "RP 1--".

5. For continual playback, press the same or another PLAY key during playback.

The playback of up to three recordings can be programmed.

When the standby number field displays a dash (—) the DRU-2 accepts the next PLAY key.

Example: Pressing the PLAY2 and PLAY3 keys in succession during PLAY1 playback.

A rectangular display box containing the text "RP 123".

6. Use the MONI control to adjust the volume.
When the playback is completed, the DRU-2 returns to the previous operating state.

4-7-3. Transmitting a Message

■ In the receive mode

1. Set the VOX/MAN switch to VOX.
2. Press the PLAY key for the desired channel to start transmission. For information about the microphone gain adjustment, see the SSB or AM transmission section.
3. When the transmission is complete, the receive mode will return automatically.

While the microphone is not operated during VOX, leave the GAIN control turned fully

■ In the transmit mode

Press the PLAY key for the desired channel to start transmission.

4-7-4. Continuous Playback

When MENU No.24 is on, REC-3 will provide continuous (loop) recording of 8 or 16 second intervals of receiver audio. At this time the REC-3/PLAY-3 key is fixed as the REC-3 key and the VOICE key function as the PLAY-3 key.

1. Turn on MENU No. 24
2. Press the REC-3 key.

The REC-3 starts recording the receiver audio. After 8 seconds, new information is recorded over the previous one. The recording time can be set to 8 or 16 seconds using MENU No.25.

If you want to save an 8 or 16 seconds segment of the recording, press the REC-3 key. This will transfer the recording into a buffer memory.

To play back the saved recording, press the VOICE key.

4-7-5. Repeat Playback

When MENU No.26 is on, recorded information is repeatedly played back. To stop playback, press the CLR key.

Example: If PLAY-1 is pressed, the PLAY-1 recording is repeatedly played back until the CLR key is pressed.

Example: If PLAY-1, PLAY-2 and PLAY-3 are pressed, all three recordings are repeatedly played back until the CLR key is pressed.

Note

You must stop continuous recording or repeat playback before shutting the transceiver off or the recording could be erased.

Menu No.27 allows the repeat playback interval to be set within the range from 0 to 60 seconds. (Initial setting: 10 seconds)

Example: If the interval is set to 20 for the playback of PLAY1 only, the PLAY1 recording is played back repeatedly with a 20-second intermission following each PLAY1 playback.

4-8. REPEATER OPERATION

Repeaters permit a very wide coverage area at relatively low power levels using the FM mode. The combination of the low noise mode combined with the generally good propagation offered by this band makes for some excellent low power contacts.

1. Set the POWER switch to ON while pressing the MENU key. Select menu number 57 with the M.CH/VFO CH control. The tone frequency is displayed. (Initial setting: 88.5 Hz)

Note

The tone frequency is available during SPLIT memory operation when both the transmit and receive frequencies are in the FM mode.

2. Select the tone frequency by using the 1MHz UP/DOWN switches.
The 39 built-in tone frequencies are shown below.

Hz	Hz	Hz
67.0	114.8	192.8
71.9	118.8	203.5
74.4	123.0	210.7
77.0	127.3	218.1
79.7	131.8	218.1
82.5	136.5	225.7
85.4	141.3	233.6
88.5	146.2	233.6
91.5	151.4	241.8
94.8	156.7	250.3
97.4	162.2	1750.0
100.0	167.9	
103.5	173.8	
107.2	179.9	
110.9	186.2	

Note

Consult your KENWOOD service center when you want to use the tone frequency of 1750 Hz.

3. When menu number 58 is selected, either the burst or continuous tone can be selected. Normally, continuous is selected.
4. Press the MENU key again.
5. First select the desired receiver frequency in the RX VFO.
6. Press the A=B key.
7. Set the TX VFO to B and select the transmit frequency for repeater operation by using the TX VFO/SUB control.
8. Press the M.IN key and store the data in the desired memory channel (00 to 89).
9. Set the TX VFO and RX VFO to M.CH to recall the memory channel.
10. Press the microphone PTT switch, or set the REC/SEND switch to SEND and speak into the microphone.

Note

Check the intended transmitter frequency before transmitting to avoid interrupting another QSO.

11. Release the PTT switch, or place the REC/SEND switch to REC.

4-9. OPERATION WITH A PERSONAL COMPUTER (Requires optional IF-232C)

Control with a personal computer is possible with the optional IF-232C interface. For more information, refer to the manuals provided with the interface.

■ Function list

- Auto information ON/OFF setting
- Same function as microphone UP/DOWN switch
- DATA mode ON/OFF setting
- VFO A, VFO B and memory frequency selection and readout
- Sub VFO frequency selection and readout
- Filter setting
- VFO A, VFO B and memory frequency TX/RX setting
- Model No. readout for transceiver recognition
- Display of transceiver's current condition
- F.LOCK ON/OFF setting and display
- Memory channel setting
- Mode setting
- Memory display
- Memory entry
- AIP switch ON/OFF setting
- CW message play back
- PITCH control setting
- RIT/XIT frequency clearance
- RIT/XIT frequency UP/DOWN
- METER switch setting
- RIT ON/OFF setting
- RX: For receive operation, TX: For transmit operation
- SUB key ON/OFF setting, TF-W key ON/OFF setting
- Scan ON/OFF setting
- Slope tune band setting and readout
- Meter signal output
- Sub-tone frequency setting
- VBT passband setting and display
- Generation of synthesized voice
- XIT ON/OFF setting

4-10. VOICE SYNTHESIZER

(Requires the use of the optional VS-2 Voice Synthesizer)

When the VOICE switch is pressed the transceiver will audibly announce the operating frequency.

4. Press the MENU key again to exit menu mode.

Menu No.	Item	Settings
18	DSP Comb filter	ON / OFF
		BPF3/BPF2/BPF1/600/

4-11. DIGITAL MODULATION

SSB, CW, AM FM and FSK transmit processing and receive processing in SSB, CW, and FSK are accomplished with 16-bit A/D and D/A convertors and DSP (Digital Signal Processor).

(1) Features of each Mode

① SSB mode

Superior sideband suppression and higher quality modulation through the use of tenth digital phase shift networks digital filtering.

② CW mode

Excellent wave shaping and narrow bandwidth using ROM filter with Gaussian characteristics.

③ AM mode

Low-distortion modulated with superb amplitude and group delay characteristics is obtained through digital modulation and 84th FIR filtering.

④ FM mode

The DSP unit provides a high-quality 455 kHz carrier in the FM mode. Modulation is not processed in the DSP unit.

⑤ FSK mode

Low-distortion wave obtained by continuous phase modulation by the DDS generator and excellent waveform shaping for high speed conversion through the use of an FIR filter with Gaussian characteristics.

(2) Setting

Five menu selections in section 4-2-12 allow you to adjust the filtering and CW rise/decay time of the DSP unit to your preference.

		500/6000
20	Transmit HPF cut-off frequency	OFF/100/200/300/400
21	Transmit LPF cut-off frequency	2600/2750/2900/3100
22	CW rise / decay time	2 / 4 / 6 / 8 mS

(3) Menu Functions

1. Menu No.18

Used to turn the DSP Comb Filter ON and OFF for SSB reception.

2. Menu No.19

Select the cut-off frequency for the DSP BPF and LPF during receive.

3. Menu No.20

Select the transmit high pass filter cut-off frequency.

4. Menu No.21

Select the transmit low pass filter cut-off frequency.

5. Menu No.22

Select the rise/decay time for CW. The 4ms setting is desirable for low speed keying with normal weighting (dot / dash ratio). The 2 ms setting is desirable for high speed keying or when operating with unusual dot/dash ratio.

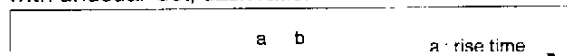

MENU SECTION

1. Set the MENU key to ON.
2. Select a menu number (18-22) with the M.CH/VFO CH control.
3. Use the UP/DOWN switches to set the filter cut-off and CW rise/decay time.

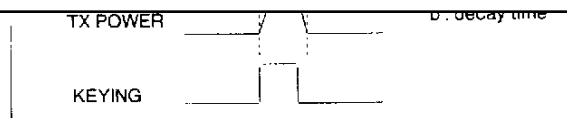

4-12. TRANSFER FUNCTION WHEN TWO TS-950SDX TRANSCEIVER ARE CONNECTED TOGETHER

When two TS-950SDX are connected together, operation data can be transferred from one TS-950SDX (master) to the other (slave).

Notes

1. Other functions may be slowed down while the data is being transferred.
2. All operation data cannot be transferred if the master transceiver is in the memory channel mode or the slave transceiver is in the Quick memory channel mode.

4-12-1. Connection

Make up a connection cable with 6-pin DIN plugs, or use a 6-pin DIN cord (1m) to connect the ACC1 connectors of the two TS-950SDX. For 6-pin DIN plugs (option, part No. E07-0654-05) or 6-pin DIN cord (option, part No. E30-3047-15), contact your nearest KENWOOD authorized service center or dealer.

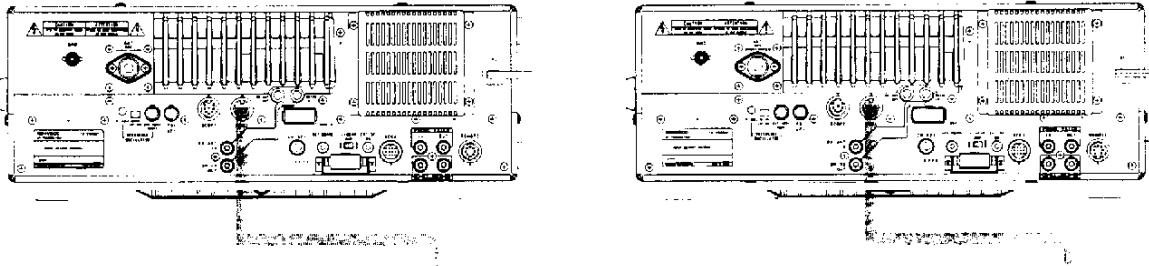

Pin No.	Signal Name	
1	GND	Signal ground
2	TXD	Transmit data
3	RXD	Receive data
4	CTS	Transmit enable
5	RTS	Receive enable
6	NC	No connection

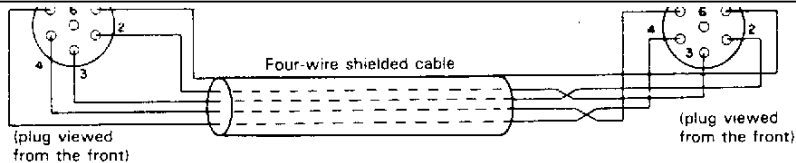

If a DSP-100 is not connected to the TS-850S transceiver, connect as shown in Figure 1.

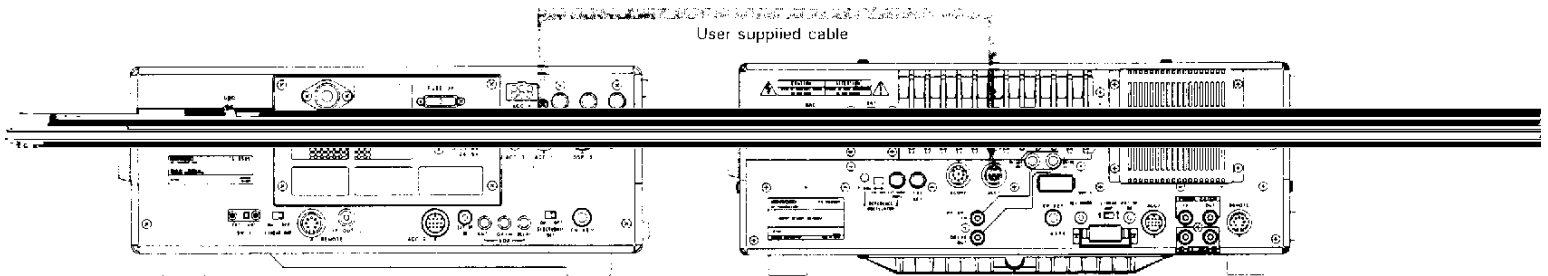
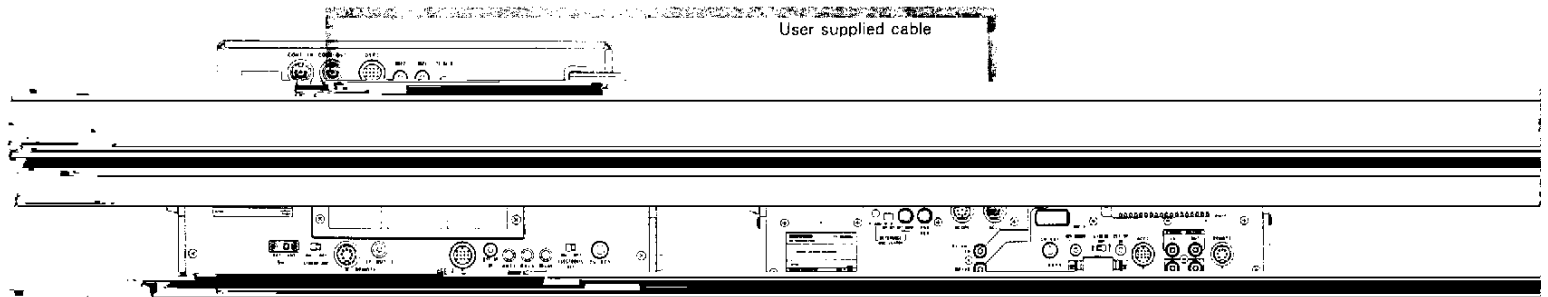

Figure 1

If a DSP-100 is connected to the TS-850S transceiver, connect as shown in Figure 2.



Note

This function does not work if the DSP-100 power is off.

4-12-2. Function Setting

Set menu No.9 to on for both TS-950SDX transceiver(Please refer to Section 4-2-12.)

4-12-3. Data That Can Be Transmitted

Data that can be transmitted includes the following: VFO frequency, VFO A / B, Filter settings, Meter Indications, AIP ON / OFF, 1MHz ON / OFF, FINE ON/OFF.

4-12-4. Operation

■ To write the same data to the quick memory channels of both transceivers

1. Set menu No.10 to OFF for the slave transceiver(Please refer to Section 4-2-12).
2. Set the data, such as the frequency to be stored in the master transceiver, and press the QUICK MEMO M.IN key of the master transceiver. The slave transceiver beeps, and the same data is written to quick memory channels 1 of both transceivers.
3. When the QUICK MEMO M.IN key is pressed, the latest data is written to channel 1. If there is already data in channel 1, it is moved to channel 2.

For the quick memory recall method, see Section 4-4-12.

■ To rewrite the VFO frequency of the slave transceiver directly

1. Set menu No.10 to ON for the slave transceiver(Please refer to Section 4-2-12).
2. Set the data, such as the frequency to be stored in the master transceiver, and press the QUICK MEMO M.IN key of the master transceiver. The data, such as the VFO frequency, in the slave transceiver is replaced by the data in the master transceiver. The same data is also written to quick memory channel 1 of the master transceiver.

4-12-5. SPLIT Function Setting

Set menu No.9 to ON for the bath transceiver (Please refer to Section 4-2-12).

[1] Data that can be transmitted

Data that can be transmitted includes the following: VFO frequency and mode.

[2] Operation

■ To write the data to the quick memory channels of slave transceiver

1. Set menu No.10 to OFF for the slave transceiver(Please refer to Section 4-2-12).
2. Set the data, such as the frequency to be stored in the master transceiver, and press the QUICK MEMO M.IN key of the master transceiver. The slave transceiver beeps, and the data is written to quick memory channels 1 of slave transceiver. The data is also written to quick memory channel 1 of the master transceiver.
3. When the QUICK MEMO M.IN key is pressed, the latest data is written to channel 1. If there is already data in channel 1, it is moved to channel 2.

For the quick memory recall method, see Section 4-4-12.

■ To rewrite the VFO frequency of the slave transceiver directly

1. Set menu No.10 to ON for the slave transceiver(Please refer to Section 4-2-12).
2. Set the data, such as the frequency to be stored in the master transceiver, and press the QUICK MEMO M.IN key of the master transceiver. The data, such as the TX VFO frequency, in the slave transceiver is replaced by the data in the master transceiver. The data is also written to quick memory channel 1 of the master transceiver.

4-13. WHEN USED AS THE MASTER MACHIN FOR THE TRANSVERTER

4-13-1 Connection

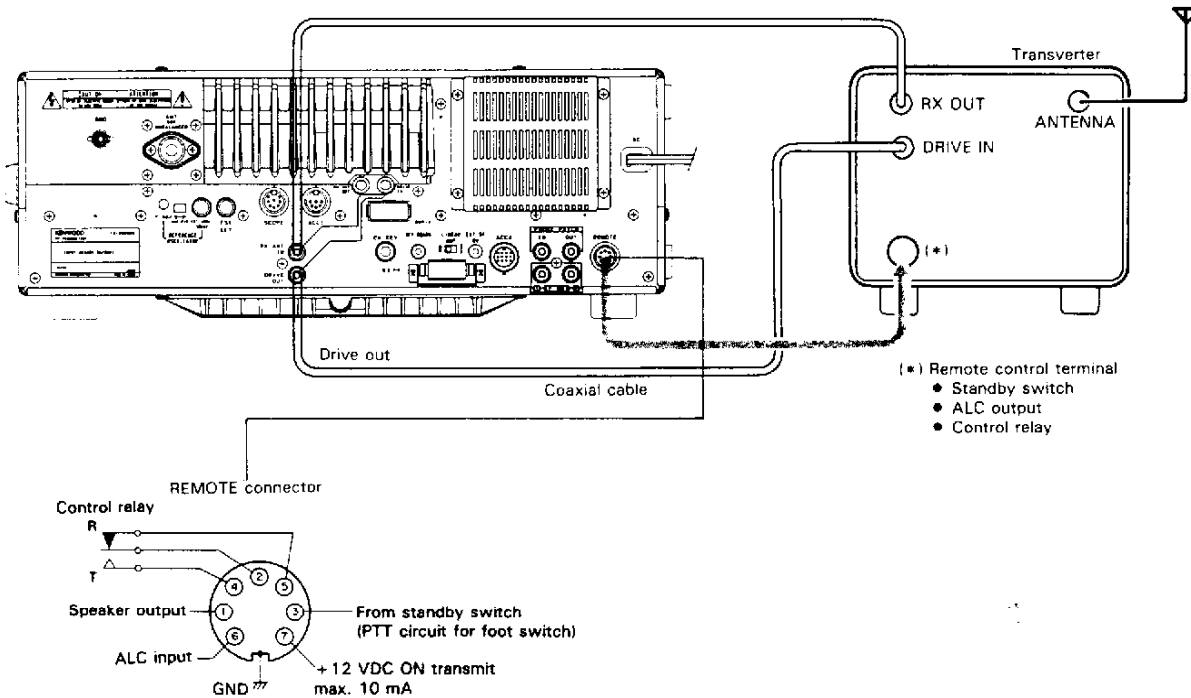

When connections are made as shown above, the PWR control on this unit does not work, so turn it fully clockwise. The external ALC input is negative. The ALC circuit operates from about -9 V.

4-13-2 Display Indicator

The frequencies corresponding to the 50, 144, and 430 MHz bands can be displayed by selection the desired band with menu No.4 (Please refer to Section 4-2-12.)

For example:

When the 28 MHz band is used as the 50 MHz band.

1. Set the receive frequency to 28.000 MHz.
2. Press MENU key.
3. Rotating the M.CH/VFO CH control to select menu No.4. Use the UP / DOWN switches to select 50MHz.
4. Press the MENU key again to turn OFF the menu. The display will read 50.000.00 MHz.

Note

If the display frequency is in the 50, 144, or 430 MHz band, the frequency cannot be set with the numeric keys.

5. MAINTENANCE AND ADJUSTMENTS

5-1. GENERAL INFORMATION

Your transceiver has been factory aligned and tested to specification before shipment. Under normal circumstances the transceiver will operate in accordance with these operating instructions. All adjustable trimmers and coils in your transceiver were preset at the factory and should only be readjusted by a qualified technician with proper test equipment. Attempting service or alignment without factory authorization can void the transceiver's warranty.

When operated properly, the transceiver can give years of service without requiring realignment. The information in this section gives some general service procedures which can be accomplished without sophisticated test equipment.

5-2. SERVICE

Should it ever become necessary to return the equipment to your dealer or service center for repair, pack in its original box and packing, and include a full description of the problems involved. Also include your telephone number. You need not return accessory items unless directly related to the service problem.

You may return your radio for service to the Authorized KENWOOD Dealer from whom you purchased it or any authorized KENWOOD service center. A copy of the service report will be returned with the unit. Please do not send sub-assemblies or printed circuit boards. Send the complete unit, in its original boxes and packing.

Tag all returned items with your name and call for identification. Please mention the model and serial number of your radio in any correspondence, whether phone or written.

Service note

Dear OM, if you desire to correspond on a technical or operational problem, please make your note short, complete, and to the point. And PLEASE make it readable.

Please list: Model and serial number.

The question or problem you are having.

Please give sufficient detail to diagnose: other equipment in the station, meter readings and anything you feel might be useful in attempting diagnosis.

Caution

Do not pack the equipment in crushed newspapers for shipment! Extensive damage may result during shipping.

Notes

1. Record the date of purchase, serial number and dealer from whom purchased.
2. For your own information, retain a written record of any maintenance performed on the unit.
3. When claiming warranty service, please include a photocopy of the bill of sale, or other proof of purchase showing the date of sale.

5-3. CLEANING

The knobs, front panel and cabinet of the transceiver are likely to become soiled after extended use. The knobs should be removed from the transceiver and cleaned with a neutral detergent and warm water. Use a neutral detergent (not harsh chemicals) and damp cloth to clean the cabinet and front panel.

5-4. IN CASE OF DIFFICULTY

The problems described in this table are failures caused in general by improper operation or connection of the transceiver, not by defective components. Examine and check according to the following table. If the problem persists, contact an authorized agent or service station.

RECEPTION

Symptom	Probable cause	Corrective action
Indicators do not light and no receiver noise is heard when the POWER switch is turned on.	Bad power cable or connections. Blown fuse.	Check cables and connections. Replace fuse.
Nothing is displayed or improper digits are displayed when the POWER switch is turned on.	The microprocessor may malfunction if the input voltage is too low.	Turn on the POWER switch while depressing the A=B (or VFO-A(RX)) key, and then release the A=B (or VFO-A(RX)) key.
When you press the POWER switch, "14 MHz USB" is displayed.	The backup battery voltage is low.	Please refer to Section 4-4-1.
No signal is received even when the antenna is connected, or the receiver sensitivity is low.	<ol style="list-style-type: none"> 1. SQL control fully clockwise. 2. The ATT switch is ON. 3. The REC/SEND switch is in the SEND position. 4. Microphone PTT switch is in the transmit position. 5. SSB SLOPE TUNE control is improperly adjusted. 6. VBT control is improperly adjusted. 	<ol style="list-style-type: none"> 1. Turn the SQL control counterclockwise. 2. Set the ATT switch to 0 dB. 3. Set the REC/SEND switch to REC. 4. Set the PTT switch to the receive position. 5. HIGH control: Fully clockwise LOW control: Fully counterclockwise 6. Fully clockwise
An antenna is connected, but no signal is received and the S-meter fully deflects. The S-meter deflects and stays at a certain position even with no signal.	RF gain control is too low, decreasing the high frequency circuit gain.	Turn the RF gain control MAX clockwise.
Signal is received, but not correct sound is heard.	MODE key position is incorrect.	Change the MODE key to the correct mode.
SSB received signal is extremely high cut or low cut.	SSB SLOPE TUNE control is improperly adjusted.	HIGH control: Fully clockwise LOW control: Fully

pressing the TUNE UP / DOWN switches, turning the TUNING knob, or M.CH/VFO CH control.

Memory scan fails.

Nothing is stored in memory.

Store the frequency.

Notes

1. Beat tones may be heard on the following frequencies. This is due to the internal frequency configuration of the radio and is not an indication of any problem. It is normal.
10.000MHz, 20.000MHz

transceiver away from the transceiver when you use it.

3. The fan motor rotates when the POWER switch is turned off, it is normal.

TRANSMIT

Symptom	Probable cause	Corrective action
No output power	<ol style="list-style-type: none">1. The microphone is not plugged in.2. Low microphone gain.3. Poor antenna connection.4. DATA mode is selected	<ol style="list-style-type: none">1. Plug the microphone in.2. Increase the MIC gain control.3. Securely connect the antenna.4. Press the current mode key.
VOX does not operate.	<ol style="list-style-type: none">1. GAIN control too low.2. ANTI control requires adjustment.	See section 4-1-1, GAIN control.
VOX trips by speaker output.	ANTI control requires adjustment.	See section 4-1-1, ANTI control.
Linear amplifier does not key.	<ol style="list-style-type: none">1. LINEAR AMP switch on rear panel was not turned ON.2. REMOTE connector is miswired, or has a poor contact.	<ol style="list-style-type: none">1. Move the switch as described in section 5-6-6.2. Correct wiring.

5-5. ORDERING SPARE PARTS

When ordering replacement or spare parts for your equipment, be sure to specify the following: Model and serial number of your transceiver. Schematic number of the part. Printed circuit board number on which the part is located, part number and name, if known, and quantity desired. Part numbers for most replacement parts are contained in the service manual (available as an option from your dealer).

5-6. ADJUSTMENTS

5-6-1. Remove the Top and Bottom Covers

Cautions

1. Before removing the cover, turn the POWER switch OFF and disconnect the power cable.
2. Voltages of approximately 80 volts are present in this transceiver!
3. Do not pinch wiring when opening or closing cases.

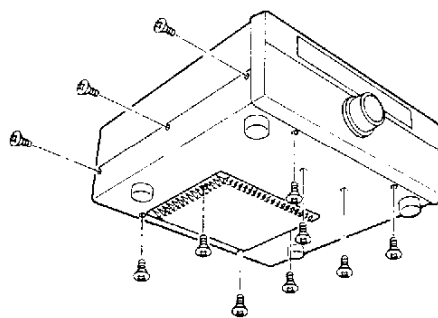
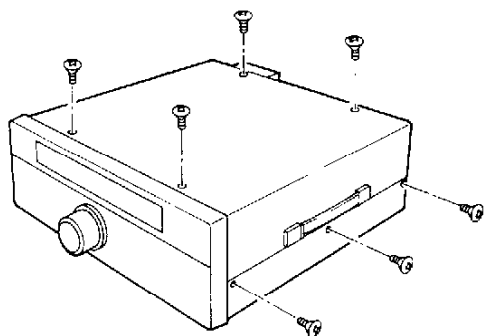

5-6-2. Remove the Subchassis

1. Remove the screws as shown in the diagram.
2. Remove the jumpers on the rear panel.
3. Open in a clockwise direction.

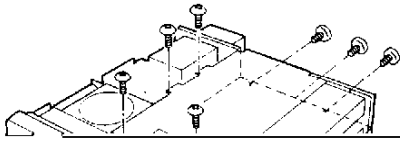

Cautions

1. Open on a flat surface.
2. Be careful not to damage the wiring.

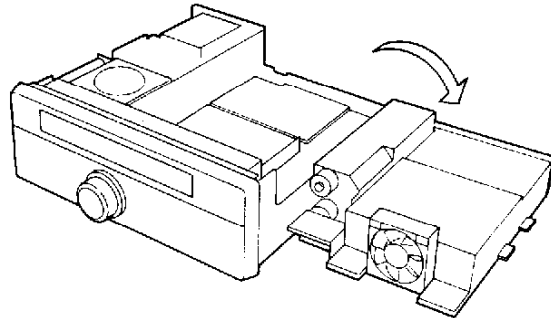
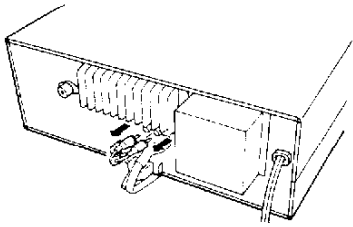

5-6-3. Sidetone Level

Turn VR2 while holding down the key in the CW mode for the desired tone level.

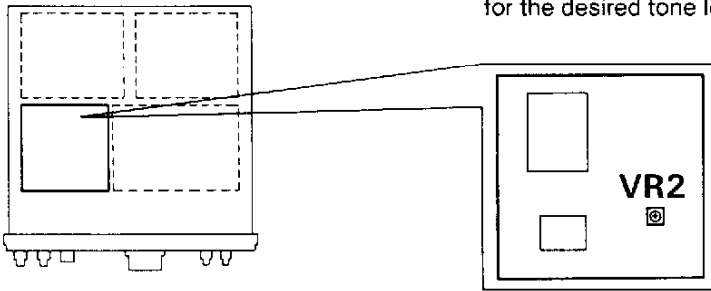

5-6-4. Beep Tone Level

Turn VR1 to the desired tone volume.

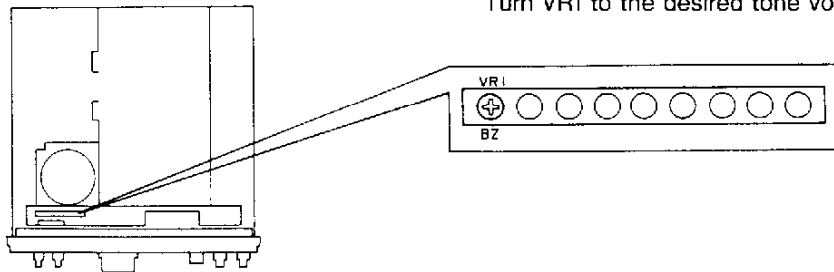

5-6-5. Adjusting the Data Communications Modulation Input Level

Set the input level for the desired modulation level with VR5. Input is reduced by turning the control counterclockwise, and increased by turning clockwise.

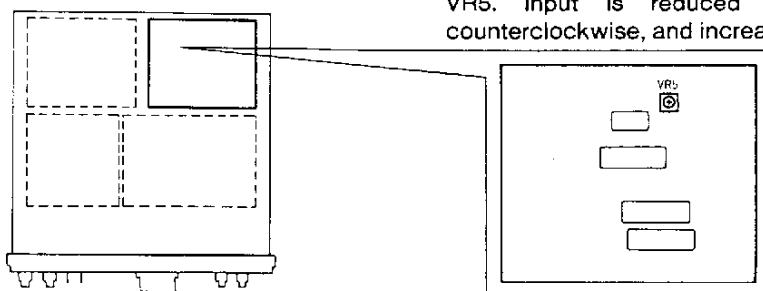

5-6-6. Linear Amplifier Control

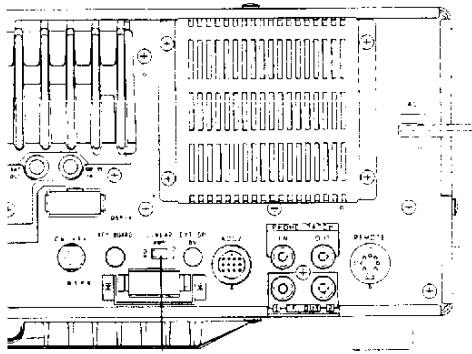

LINEAR AMP switch

The external control relay is not activated at the factory so that the operation of the radio will remain at the lowest mechanical noise level during CW Full break-in operations. If the use of this control relay is required, such as for use with an external linear amplifier. It may be activated by setting the LINEAR AMP switch to ON.

12 volts at approximately 10 mA maximum is available at pin number 7 of the REMOTE connector for control of an external keying relay, if necessary. We recommend the use of a 7 pin DIN plug for this connection. When operation of this transceiver with the TL-922/922A is anticipated you should use the control cable supplied

Most linear amplifiers require a ground on transmit. This is available by connecting pin 2 of the remote connector to ground. Then connect the center conductor of your linears relay control line to pin 4. The relay in this transceiver is capable of handling 100V DC at 500 mA.

Note

The TL-922/922A is NOT designed for Full Break-in operation. Attempting operation of the linear in this mode might lead to damage in the linear amplifier.

CW SEMI break-in switching time:

The TS-950SDX RX to TX switching time in semibreak-in is approximately 15ms. At key down, the transceiver may see an open circuit because the liner amplifier keying relay has not engaged. As a result, the transceivers protection circuit turns on, causing the output power to be reduced. If this should occur, cut jumper W1 as show in the illustration. This will change the RX to TX switching time to approximately 30ms. The full break-in switching time is not affected by this change.

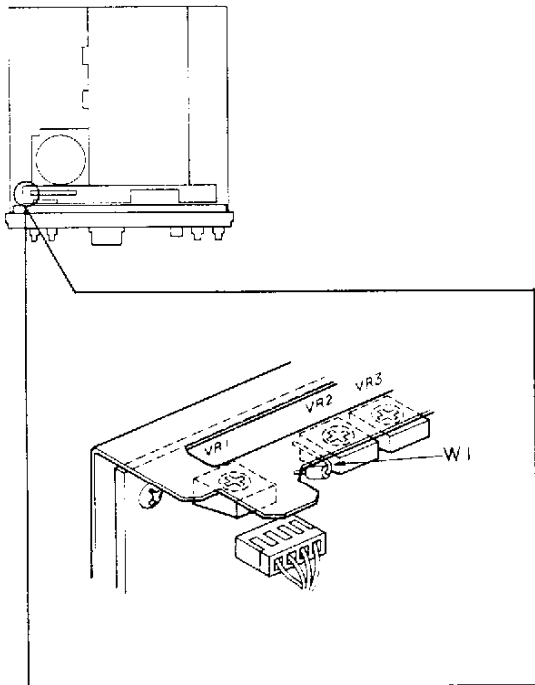

W1	Switching Time	
	SEMI	FULL
Connected	Approx. 15 ms	Approx. 15 ms
Open	Approx. 30 ms	Approx. 15 ms

5-6-7. External Frequency Standard Calibration

You might wish to use an external frequency standard to accomplish the zero beat procedure. We would recommend the use of a standard that is capable of providing 1Vp-p at 10 kHz. When using the external frequency standard you should place the REFERENCE OSCILLATOR switch to the EXT. position.

Notes

1. Before adjustment, set the SO/OSC switch (located near the SO-2) to OSC.
2. You must not touch the frequency adjustment trimming capacitor (F ADJ) since it has already been adjusted at the factory.

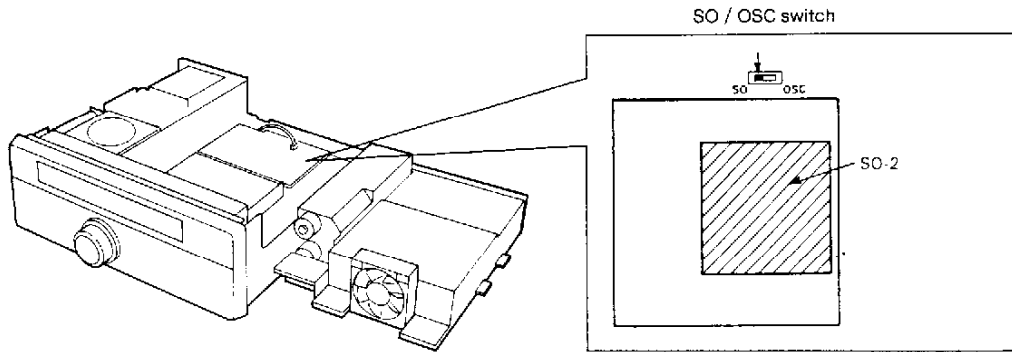
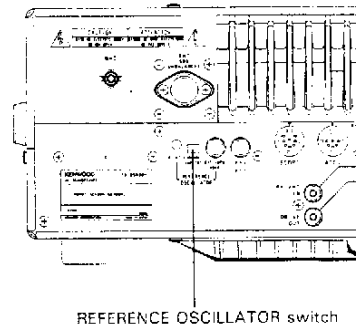

5-6-8. When using the internal electronic keyer and an external keyer at the same time

The keyboard jack connected to the back panel is a stereo type jack and is as shown below.

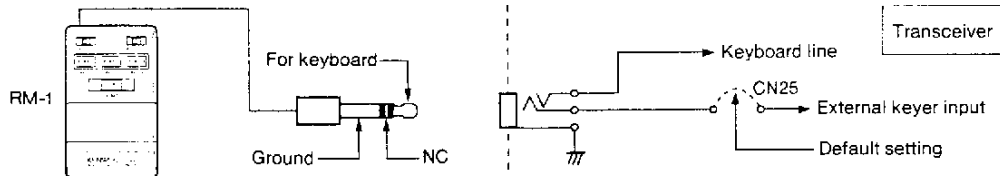

Obtain a 3.5 diameter stereo plug and jack. Connect as shown below to use the internal electronic keyer and the external keyer simultaneously.

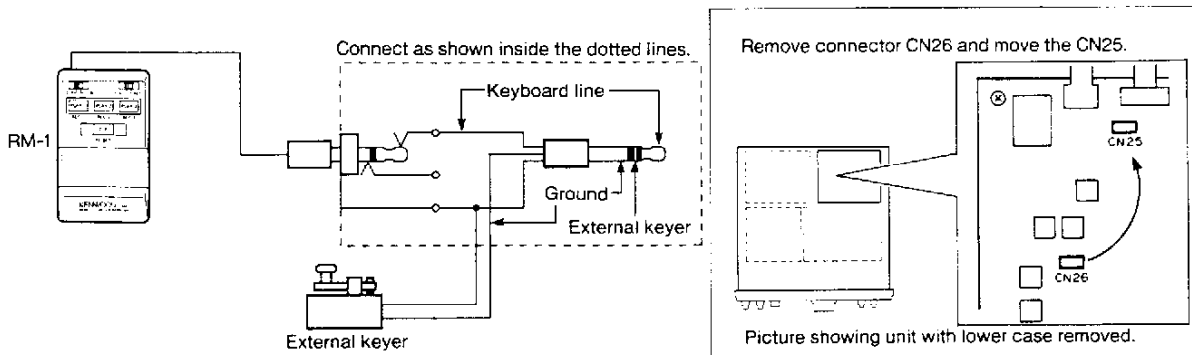

Note

When the modified plug is inserted or removed from the key jack the transceiver might key momentarily. To prevent this from occurring make sure full break-in is turned off and select a mode other than CW. When the plug is inserted or removed you may return to break-in mode, return to CW.

6. OPTIONAL ACCESSORIES

Be sure to unplug the AC power cable before starting work.

6-1. DRU-2 DIGITAL RECORDING UNIT INSTALLATION

1. Remove the top cover of the transceiver. Refer to Section 5-6-1.
2. Using the tapping screw supplied with the DRU-2, install the DRU-2 on the chassis.
3. Attach the three cables from the DRU-2 as shown.

Note
Keep the cushions provided with the DRU-2 for later use. They are not needed now.

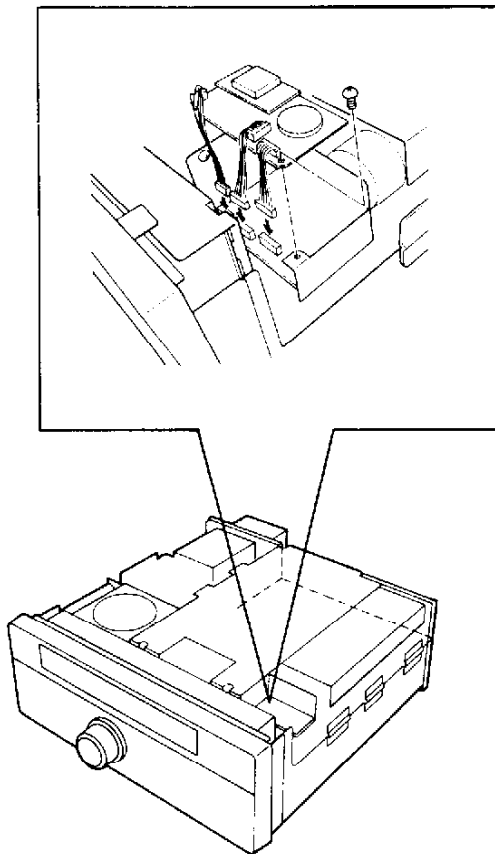

4. Replace the top cover.

6-2. OPTIONAL FILTER INSTALLATION

[1] Install

1. Remove the bottom cover of the transceiver. Refer to Section 5-6-1.
2. Remove the screws from where filters will be installed as shown below.

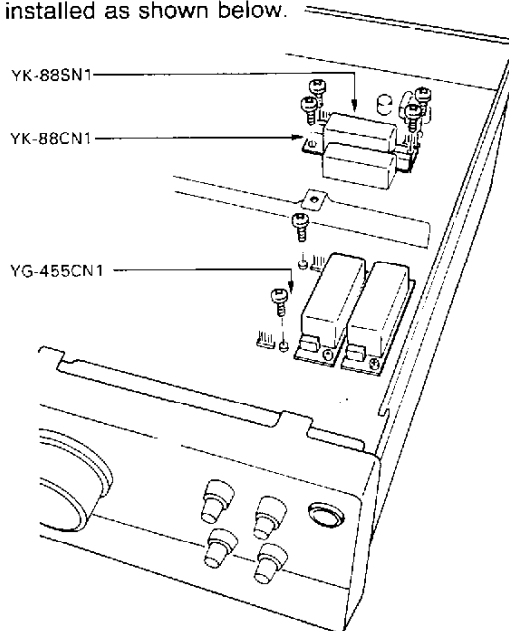

3. Attach the filter(s) and secure it with the screws you just removed. The filters are not polarized so they may be placed in either direction.

[2] Rewriting Set Menu.

1. Turn on the POWER while pressing the ENT key.
2. A menu number is displayed.
3. Select the menu number that corresponds to the filter(s) you are installing by rotation the M.CH/VFO.CH knob.
4. Activate the filter with the UP/DOWN switches.

● Option Setting Menu

Menu number	IF	Band width	Initial setting
01	8.83(MHz)	270(Hz)	OFF
02	8.83(MHz)	500(Hz)	ON
03	8.83(MHz)	1.8(kHz)	OFF
04	455(kHz)	250(Hz)	OFF
05	455(kHz)	500(Hz)	ON
06	SUB(10.095MHz)	500(Hz)	ON

5. Press the CLR or ENT key to complete the filter programming.
6. Replace the bottom cover.

Note

Avoid pinching your fingers and the wiring harness when replacing the bottom cover.

6-3. VS-2 VOICE SYNTHESIZER INSTALLATION

1. Remove the top and bottom covers and open the subchassis. Refer to Section 5-6-1 and 5-6-2.

Caution

Open on a flat surface.

2. Plug the 8-pin connector onto the VS-2.
3. Use the three screws supplied with the VS-2 to install the VS-2 on the subchassis.

Caution

Keep the pan-head screw and cushion provided with the VS-2 for possible later use. They are not needed now.

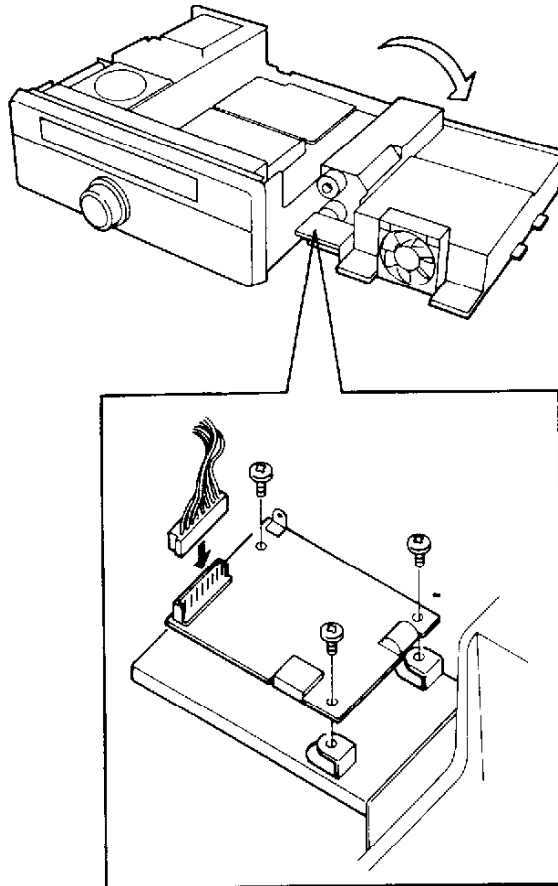

4. Close the subchassis and replace the top and bottom covers.

Note

Avoid pinching your fingers and the wiring harness when replacing the cover.

6-4. OTHER ACCESSORIES

■MC-90 MICROPHONE(8-pin)

KENWOOD designed the MC-90 microphone for use with equipment that provides transmit Digital Signal Processing. Optimum frequency response and signal clarity are obtained from the use of a specially designed microphone element.

A second output connection provides an easy way to attach an additional transceiver.



MC-90

■MC-85 MICROPHONE(8-pin)

The MC-85 is a unidirectional high-class electret condenser microphone provided with an output selector switch, audio level compensation circuit, low cut filter, level meter, PTT and LOCK switches. An 8-pin cable is provided, with optional cables, up to three outputs are possible.



MC-85

■MC-80 MICROPHONE(8-pin)

The MC-80 is an omnidirectional electret condenser microphone provide with UP / DOWN switches, volume adjustment for output level, PTT and LOCK switches, built-in preamplifier.

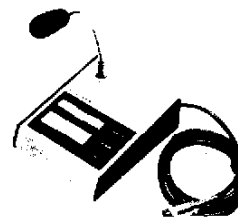

■MC-60A MICROPHONE(8-pin)

The zinc die-cast base provides high stability, and the MC-60A is complete with PTT and LOCK

■MC-43S UP/DOWN HAND MICROPHONE

The MC-43S is a handy dynamic microphone with PTT switch and UP/DOWN switches.



MC-60A

■LF-30A LOW PASS FILTER



MC-43S

■SP-950 EXTERNAL SPEAKER

Designed to match the TS-950S/950S DIGITAL/TS-950SDX.

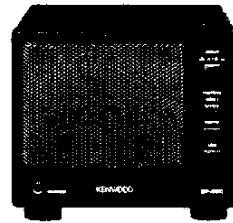

SP-950

■TL-922/922A HF LINEAR AMPLIFIER

(Not for QSK operation.)

The TL-922/922A is an HF linear amplifier employing a pair of 3-500Z high performance transmitting tubes. TL-922A (without 10 meter band) is available only in THE U.S.A.

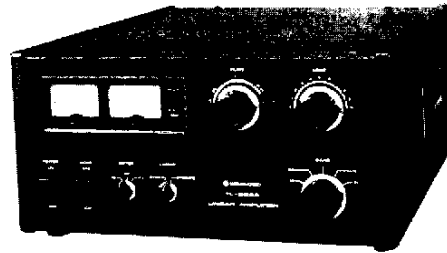

TL-922A/TL-922

■SM-230 STATION MONITOR

Built around a basic 10 MHz oscilloscope, the SM-230 station monitor features a variety of waveform-observing capabilities and a built-in tow-tone generator.

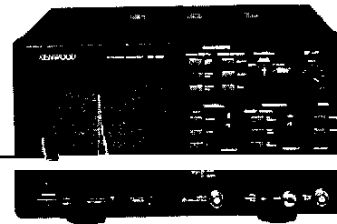

SM-230

■IF-232C INTERFACE

The IF-232C Interface is the adapter for connection between the RS-232C terminal of a personal computer and the interface terminal of the TS-950SDX.

■HS-6 MONORAL TYPE COMMUNICATIONS HEADPHONES (12.5 OHMS)

Deluxe, very light-weight headphones designed for communications equipment.



HS-6

■HS-5 MONORAL TYPE COMMUNICATIONS HEADPHONES (8 OHMS)

Headphones designed for communications equipment. These light-weight open air-type headphones remain comfortable during long operation. Easily attached earpads are provided.



HS-5

■YG-455CN-1 CW FILTER

Center frequency	: 455.0 kHz
Pass band width	: 250 Hz (-6 dB)
Attenuation band width	: 480 Hz (-60 dB)
Guaranteed attenuation	: More than 80 dB

■YK-88CN-1 CW FILTER

Center frequency	: 8830.0 kHz
Pass band width	: 270 Hz (-6 dB)
Attenuation band width	: 1.1 kHz (-60 dB)
Guaranteed attenuation	: More than 80 dB

■YK-88SN-1 SSB FILTER

Center frequency	: 8830.0 kHz
Pass band width	: 1.8 kHz (-6 dB)
Attenuation band width	: 3.3 kHz (-60 dB)
Guaranteed attenuation	: More than 80 dB

7. REFERENCE

7-1. ANTENNA INSTALLATION

■ Fixed Station

For HF fixed-station operation, an antenna specifically designed for amateur operation is recommended. Antenna types include wire antennas, verticals, rotary beams, and other antenna types(Fig. 8-1). HF antennas are quite large and must be installed to withstand strong wind, heavy rain, etc.

Any antenna used with this transceiver should be of 50-ohm impedance and should be connected using an appropriate coaxial cable such as 5D-2V.

Impedance matching is important. Impedance mismatching will result in a high VSWR and power loss, or can cause unwanted harmonic radiation and interference (TVI, BCI).

The impedance match can be checked with an SWR meter. Generally, satisfactory operation is assured when the VSWR (Voltage Standing Wave Ratio) is less than 1.5 : 1.

A rotary beam antenna is very effective for DX communication in the 14, 21 and 28 MHz bands(Fig. 8-2). If open wire or balanced type transmission line is used with the antenna, a suitable antenna tuner with balun is recommended between the transceiver and the feed line. Methods of construction and operating such tuners are described in detail in the ARRL Antenna Handbook, or similar publications.

For operation on the 160, 75 and 40 meter bands, a simple dipole antenna, cut to resonance in the most used portion of the band, will perform satisfactorily.

For operation on the 10, 15 and 20 meter bands, the efficiency of the station will be greatly increased if a good directional rotary antenna is used. Remember that even the most sophisticated transceiver is useless without a good antenna.

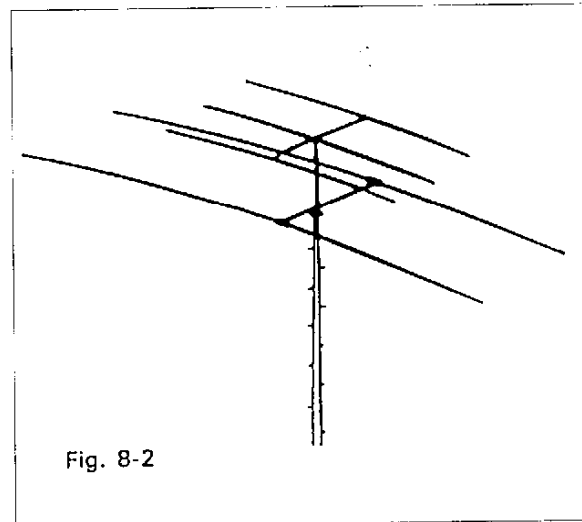
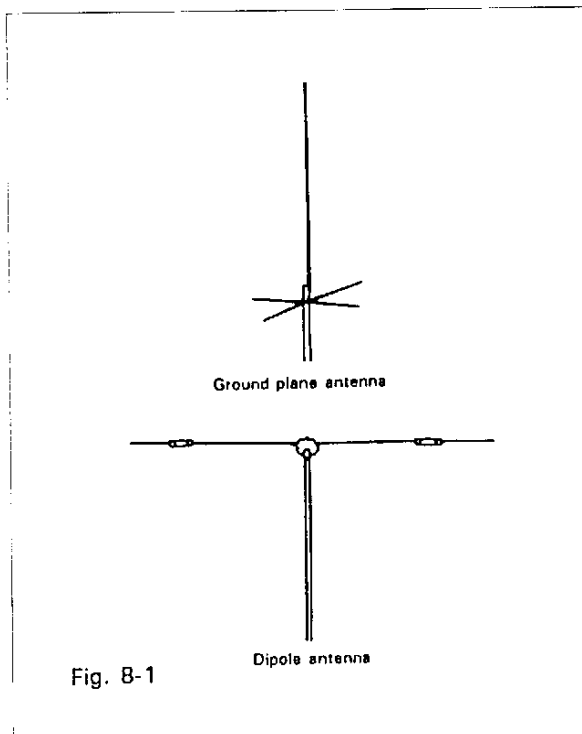

7-2. RADIO FREQUENCY ALLOCATION

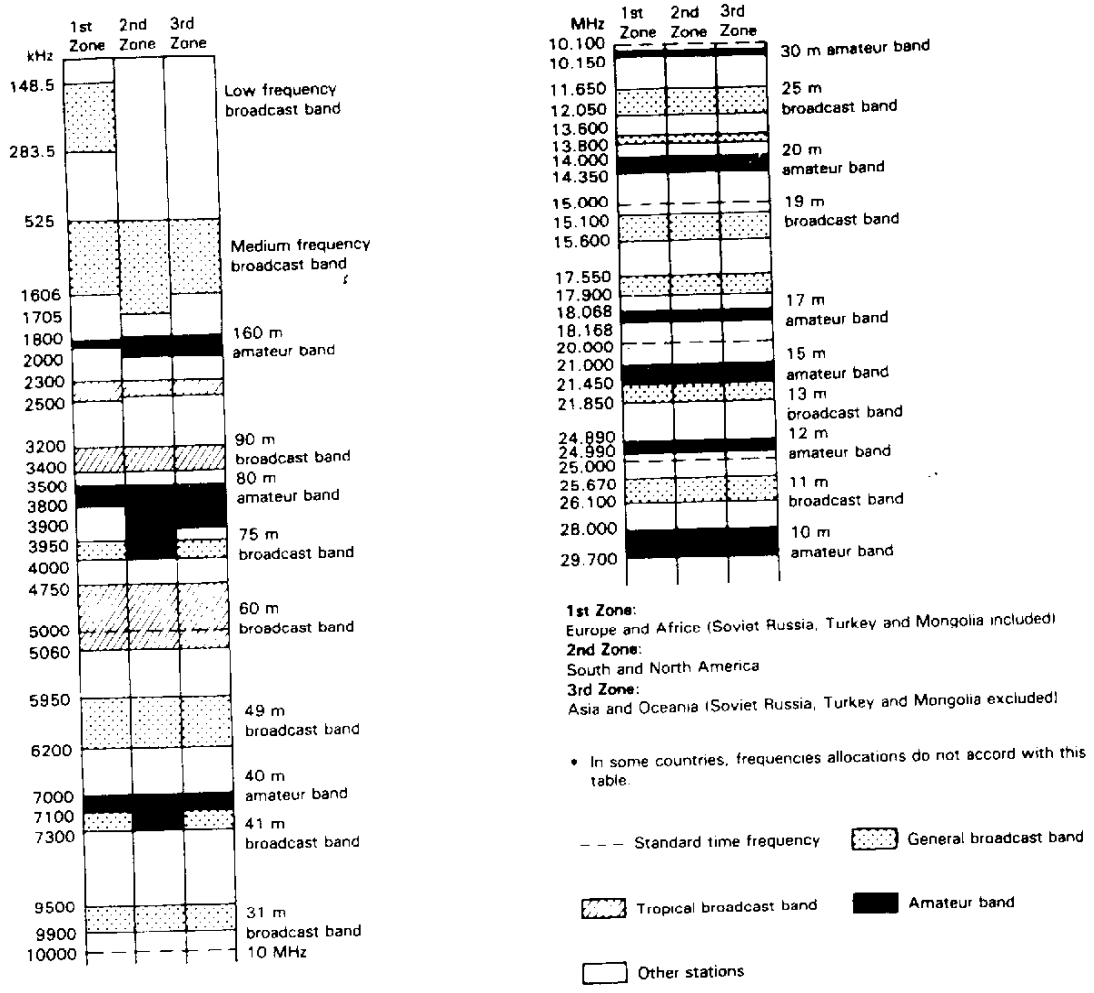

Frequency distribution in the broadcast and amateur bands
 The general coverage receiver covers from 100 kHz to 30 MHz, to receive international broadcast and communication services.
 As shown in the frequency allocation chart, above figure, broadcast and amateur radio station frequencies are allocated in specific bands expressed in megahertz (MHz) or wavelength in meters (m). Also in the above figure the frequency of "other stations" are assigned for fixed station business use, marine mobile, aviation mobile, land mobile, radio beacon stations, etc.

- Notes**
1. Radio stations throughout the world are listed in the WORLD RADIO TV HANDBOOK or similar publications.
 2. Antennas designed for ham band operation will generally provide satisfactory reception for SW stations near the ham bands. For antenna construction details, see the ARRL ANTENNA HANDBOOK, or similar publications.

KENWOOD
